

Attachment E:  
**Kickapoo Rail Trail Phase 1**  
**Construction Plans**  
**Sheets 45-105**

CONTRACT NO. 91520

ROUTE NO.	SECTION	COUNTY	TOTAL SHEETS	SHEET NO.
KICKAPOO TRAIL	08-F3000-02-BT	CHAMPAIGN	262	45
STA.	TO STA.			
F.H.W.A. REG.	ILLINOIS	PROJECT		

**NOTE:**  
 IF ANY TREE OUTSIDE OF THE LIMITS OF CONSTRUCTION THAT ARE ADVERSELY AFFECTED DUE TO CONSTRUCTION ACTIVITIES INCLUDING, BUT NOT LIMITED TO, ROOT DISTURBANCE, BARK REMOVAL, LIMB DAMAGE, THE TREE SHALL BE REMOVED IN ITS ENTIRETY AND HAULED OFF THE SITE AND DISPOSED OFF LEGALLY AT THE CONTRACTOR'S EXPENSE.  
 THE CONTRACTOR SHALL MAKE EVERY EFFORT TO LIMIT HIS OPERATIONS WITHIN THE DESIGNATED LIMITS OF CONSTRUCTION.  
 AT THE OPTION OF THE CCFP, TREES DAMAGED AND REMOVED OUTSIDE OF THE LIMITS OF CONSTRUCTION, THE COST OF REPLACING SAID TREES SHALL BE BORNE BY THE CONTRACTOR.

URBANA, IL

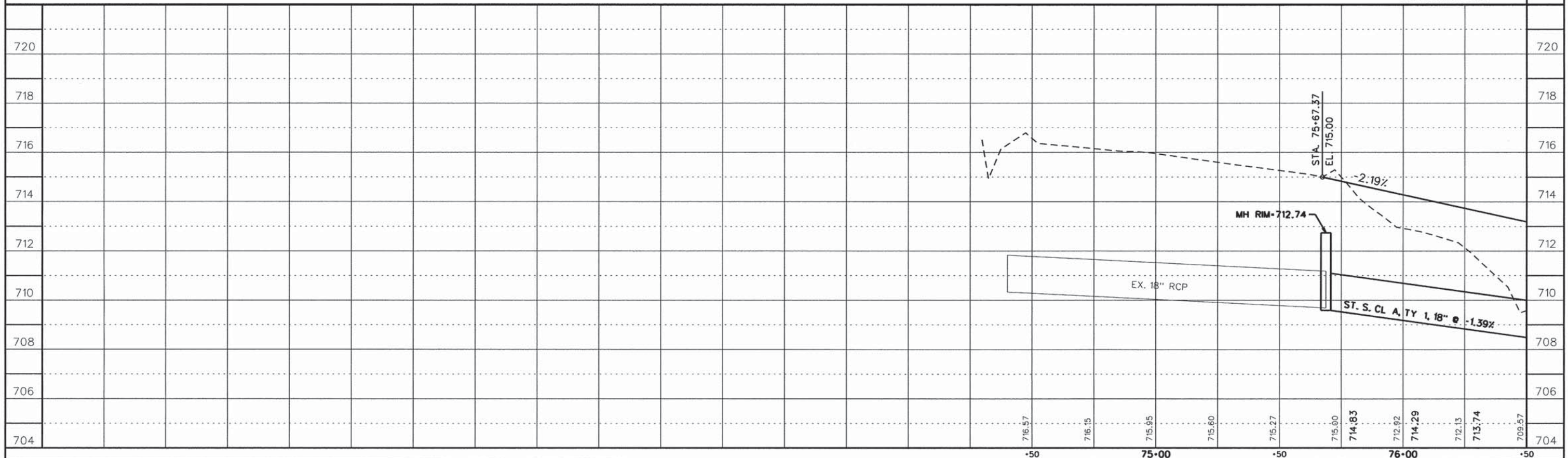
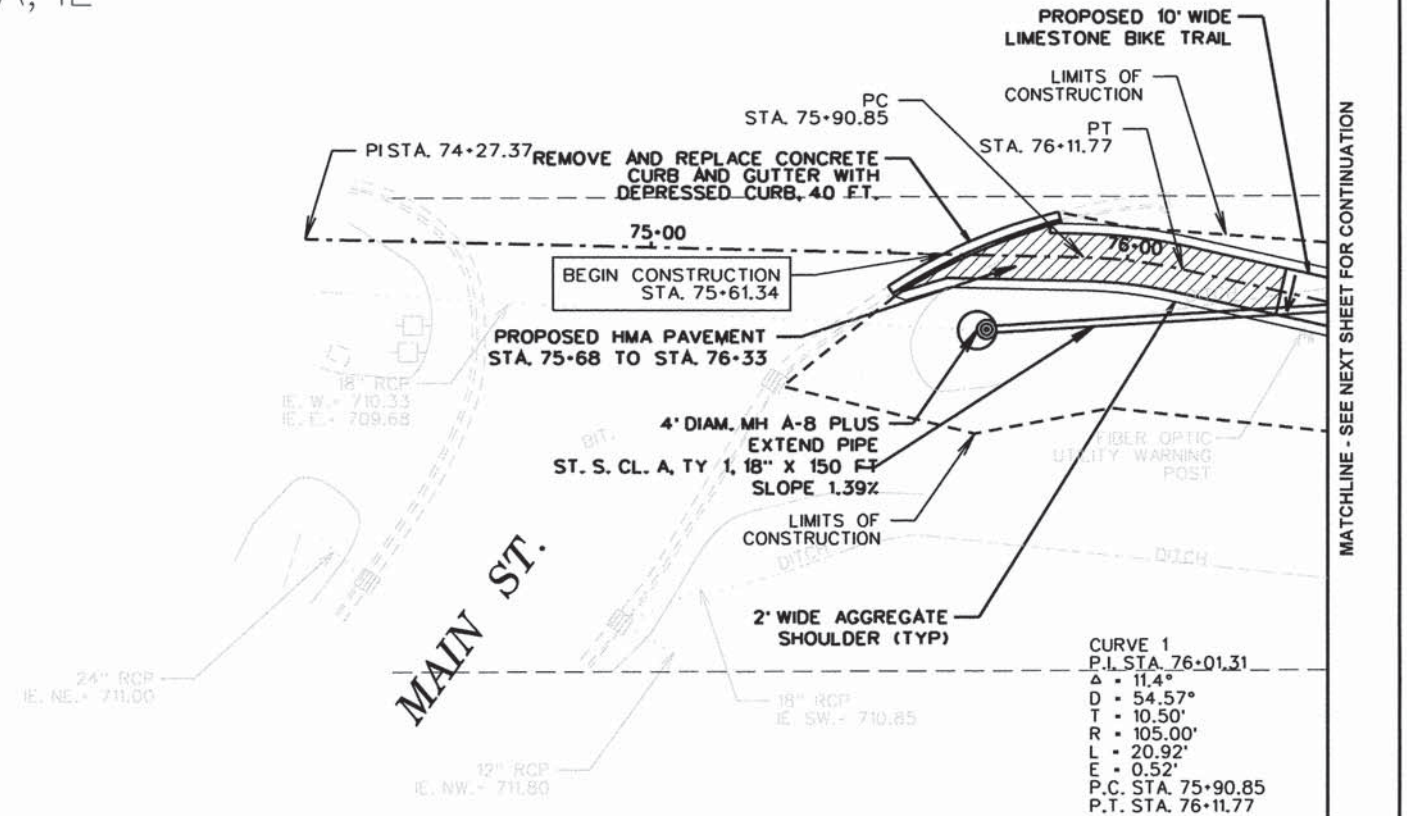
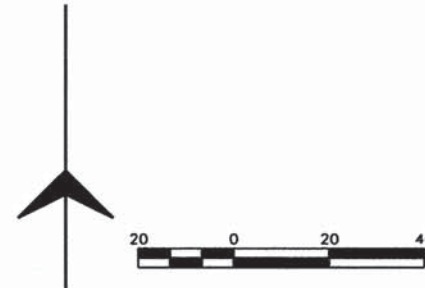

# URBANA, IL

CONTRACT NO. 91520

ROUTE NO.	SECTION	COUNTY	TOTAL SHEETS	SHEET NO.
KICKAPOO TRAIL	08-F3000-02-BT	CHAMPAIGN	262	46
STA.	TO STA.			
F.H.W.A. REG.	ILLINOIS	PROJECT		

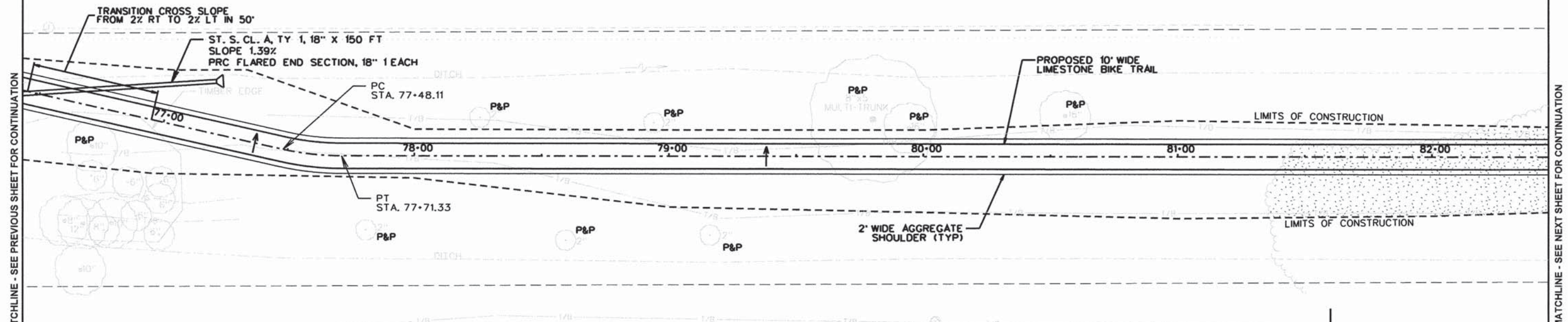

**NOTE:**

CURVE 2  
 P.I. STA. 77+59.72  
 $\Delta = 12.7^\circ$   
 $D = 54.57'$   
 $T = 11.66'$   
 $R = 105.00'$   
 $L = 23.22'$   
 $E = 0.65'$   
 P.C. STA. 77+48.11  
 P.T. STA. 77+71.33

IF ANY TREE OUTSIDE OF THE LIMITS OF CONSTRUCTION THAT ARE ADVERSELY AFFECTED DUE TO CONSTRUCTION ACTIVITIES INCLUDING, BUT NOT LIMITED TO, ROOT DISTURBANCE, BARK REMOVAL, LIMB DAMAGE, THE TREE SHALL BE REMOVED IN ITS ENTIRETY AND HAULED OFF THE SITE AND DISPOSED OFF LEGALLY AT THE CONTRACTOR'S EXPENSE.

THE CONTRACTOR SHALL MAKE EVERY EFFORT TO LIMIT HIS OPERATIONS WITHIN THE DESIGNATED LIMITS OF CONSTRUCTION.

AT THE OPTION OF THE CCFP, TREES DAMAGED AND REMOVED OUTSIDE OF THE LIMITS OF CONSTRUCTION, THE COST OF REPLACING SAID TREES SHALL BE BORNE BY THE CONTRACTOR.

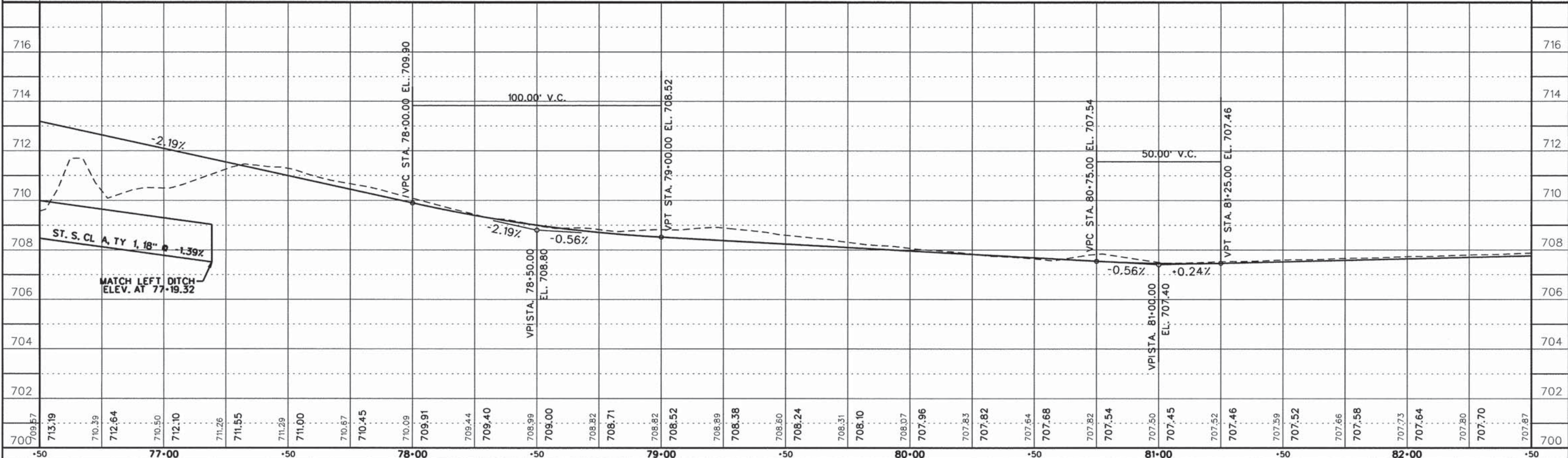
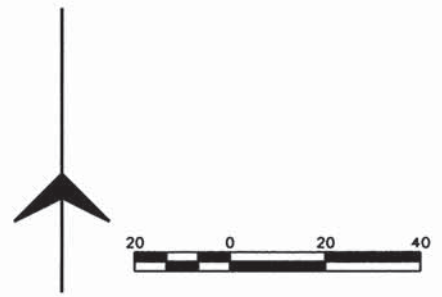

# URBANA, IL

CONTRACT NO. 91520

ROUTE NO.	SECTION	COUNTY	TOTAL SHEETS	SHEET NO.
KICKAPOO TRAIL	08-F3000-02-BT	CHAMPAIGN	262	47
STA.		TO STA.		
F.H.W.A. REG.		ILLINOIS PROJECT		

MATCHLINE - SEE PREVIOUS SHEET FOR CONTINUATION

MATCHLINE - SEE NEXT SHEET FOR CONTINUATION

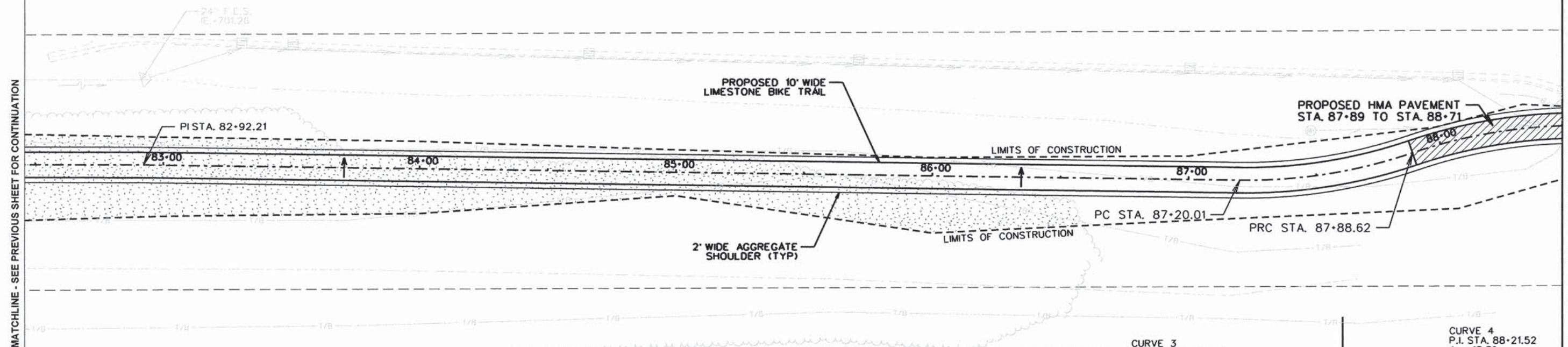

**NOTE:**  
 IF ANY TREE OUTSIDE OF THE LIMITS OF CONSTRUCTION THAT ARE ADVERSELY AFFECTED DUE TO CONSTRUCTION ACTIVITIES INCLUDING, BUT NOT LIMITED TO, ROOT DISTURBANCE, BARK REMOVAL, LIMB DAMAGE, THE TREE SHALL BE REMOVED IN ITS ENTIRETY AND HAULED OFF THE SITE AND DISPOSED OFF LEGALLY AT THE CONTRACTOR'S EXPENSE.  
 THE CONTRACTOR SHALL MAKE EVERY EFFORT TO LIMIT HIS OPERATIONS WITHIN THE DESIGNATED LIMITS OF CONSTRUCTION.  
 AT THE OPTION OF THE CCFP, TREES DAMAGED AND REMOVED OUTSIDE OF THE LIMITS OF CONSTRUCTION, THE COST OF REPLACING SAID TREES SHALL BE BORNE BY THE CONTRACTOR.

**CURVE 3**  
 P.I. STA. 87+54.32  
 $\Delta = 19.7^\circ$   
 $D = 28^\circ 38' 52''$   
 $T = 34.65'$   
 $R = 200.00'$   
 $L = 68.61'$   
 $E = 2.98'$   
 P.C. STA. 87+20.01  
 P.R.C. STA. 87+88.62

**CURVE 4**  
 P.I. STA. 88+21.52  
 $\Delta = 18.8^\circ$   
 $D = 28^\circ 38' 52''$   
 $T = 33.20'$   
 $R = 200.00'$   
 $L = 65.79'$   
 $E = 2.74'$   
 P.R.C. STA. 87+88.62  
 P.T. STA. 88+54.41

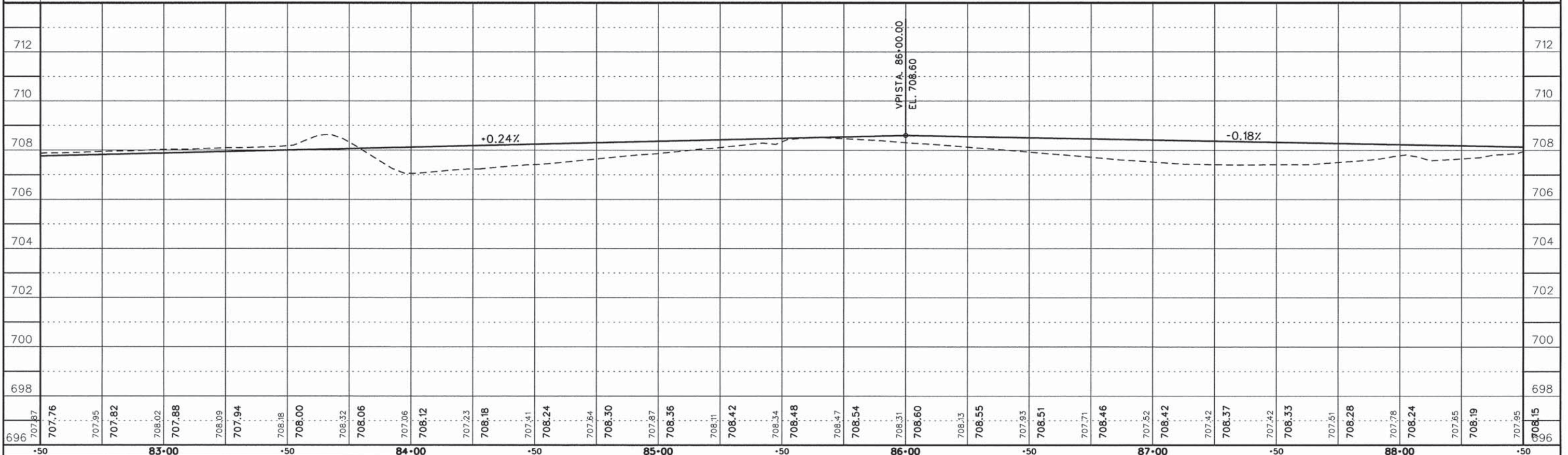
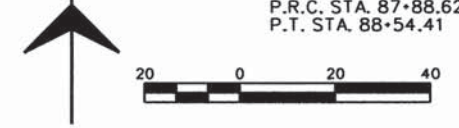

CONTRACT NO. 91520

ROUTE NO.	SECTION	COUNTY	TOTAL SHEETS	SHEET NO.
KICKAPOO TRAIL	08-F3000-02-BT	CHAMPAIGN	262	48
STA.	TO STA.			
F.H.W.A. REG.	ILLINOIS	PROJECT		

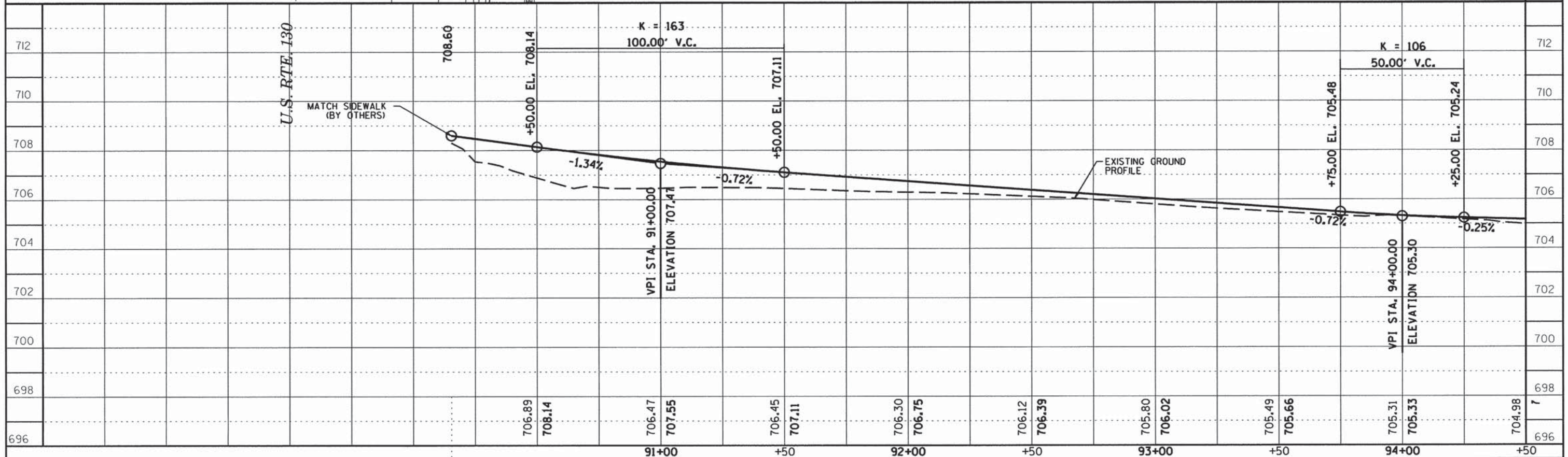
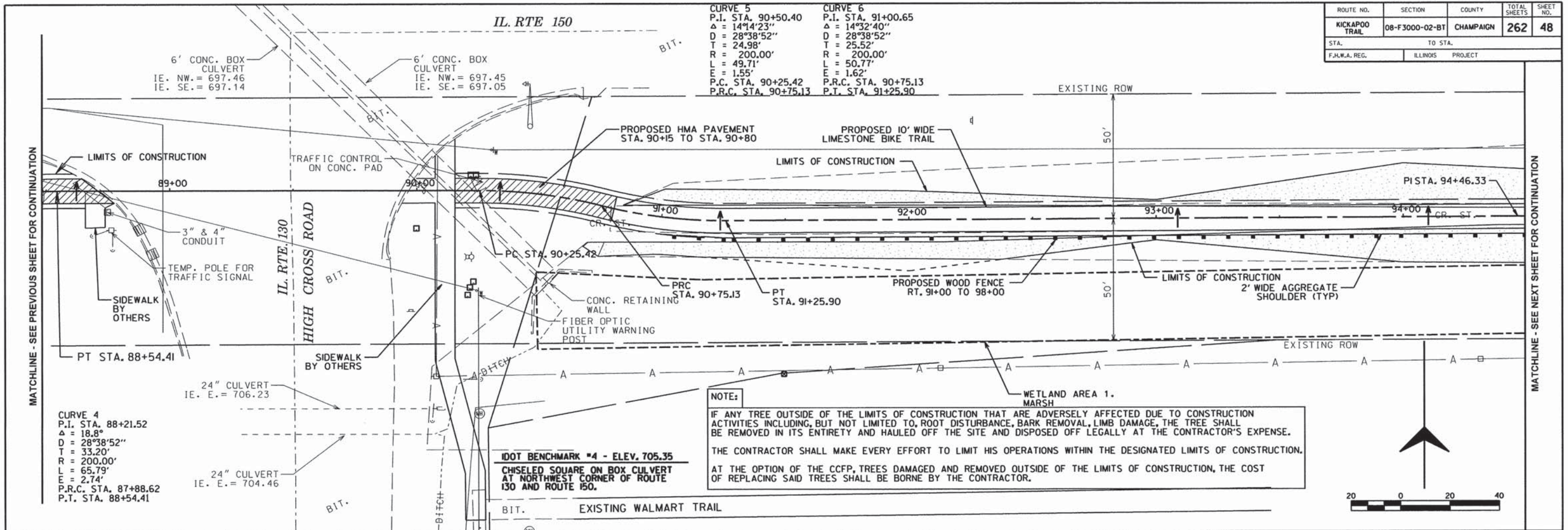

CONTRACT NO. 91520

ROUTE NO.	SECTION	COUNTY	TOTAL SHEETS	SHEET NO.
KICKAPOO TRAIL	08-F3000-02-BT	CHAMPAIGN	262	49
STA.	TO STA.			
F.H.W.A. REG.	ILLINOIS	PROJECT		



**NOTE:**  
 IF ANY TREE OUTSIDE OF THE LIMITS OF CONSTRUCTION THAT ARE ADVERSELY AFFECTED DUE TO CONSTRUCTION ACTIVITIES INCLUDING, BUT NOT LIMITED TO, ROOT DISTURBANCE, BARK REMOVAL, LIMB DAMAGE, THE TREE SHALL BE REMOVED IN ITS ENTIRETY AND HAULED OFF THE SITE AND DISPOSED OFF LEGALLY AT THE CONTRACTOR'S EXPENSE.  
 THE CONTRACTOR SHALL MAKE EVERY EFFORT TO LIMIT HIS OPERATIONS WITHIN THE DESIGNATED LIMITS OF CONSTRUCTION.  
 AT THE OPTION OF THE CCFP, TREES DAMAGED AND REMOVED OUTSIDE OF THE LIMITS OF CONSTRUCTION, THE COST OF REPLACING SAID TREES SHALL BE BORNE BY THE CONTRACTOR.

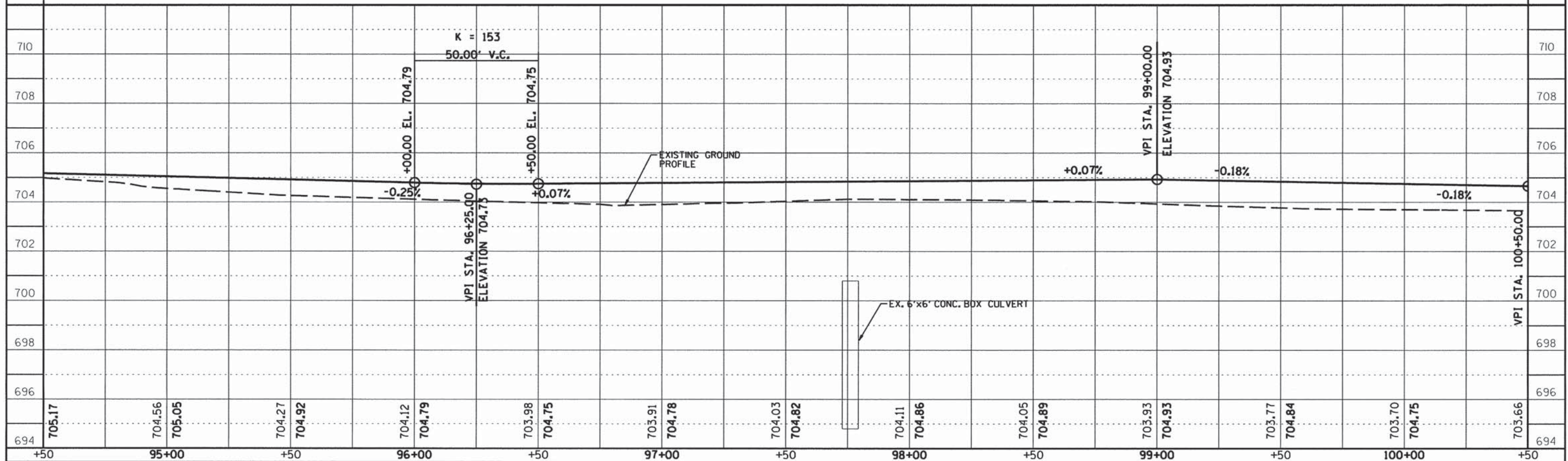
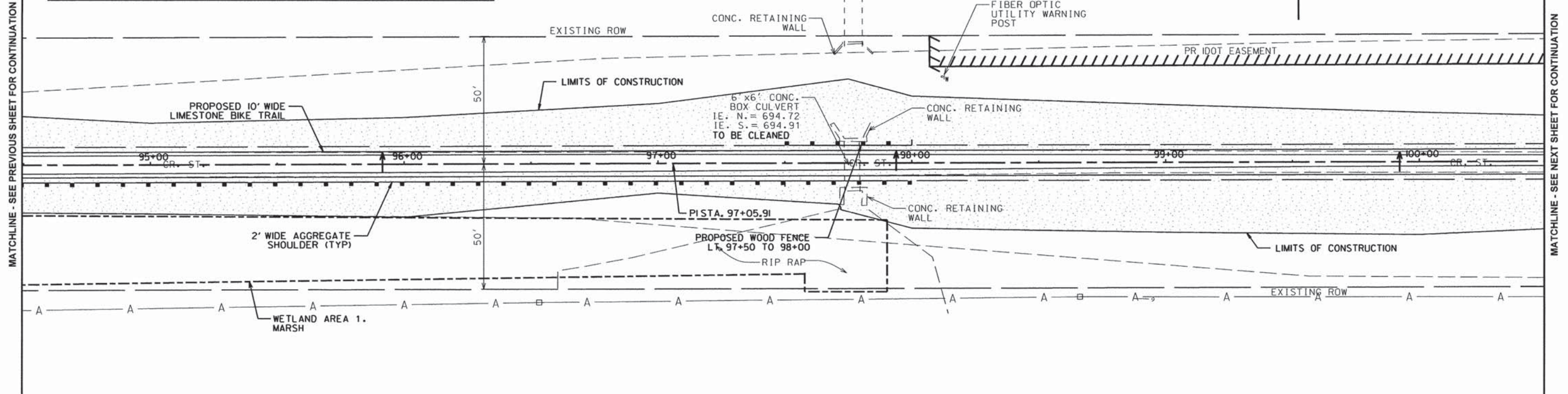

CONTRACT NO. 91520

ROUTE NO.	SECTION	COUNTY	TOTAL SHEETS	SHEET NO.
KICKAPOO TRAIL	08-F3000-02-BT	CHAMPAIGN	262	50
STA.	TO STA.			
F.J.H.W.A. REG.	ILLINOIS	PROJECT		

**NOTE:**  
 IF ANY TREE OUTSIDE OF THE LIMITS OF CONSTRUCTION THAT ARE ADVERSELY AFFECTED DUE TO CONSTRUCTION ACTIVITIES INCLUDING, BUT NOT LIMITED TO, ROOT DISTURBANCE, BARK REMOVAL, LIMB DAMAGE, THE TREE SHALL BE REMOVED IN ITS ENTIRETY AND HAULED OFF THE SITE AND DISPOSED OFF LEGALLY AT THE CONTRACTOR'S EXPENSE.  
 THE CONTRACTOR SHALL MAKE EVERY EFFORT TO LIMIT HIS OPERATIONS WITHIN THE DESIGNATED LIMITS OF CONSTRUCTION.  
 AT THE OPTION OF THE CCFP, TREES DAMAGED AND REMOVED OUTSIDE OF THE LIMITS OF CONSTRUCTION, THE COST OF REPLACING SAID TREES SHALL BE BORNE BY THE CONTRACTOR.

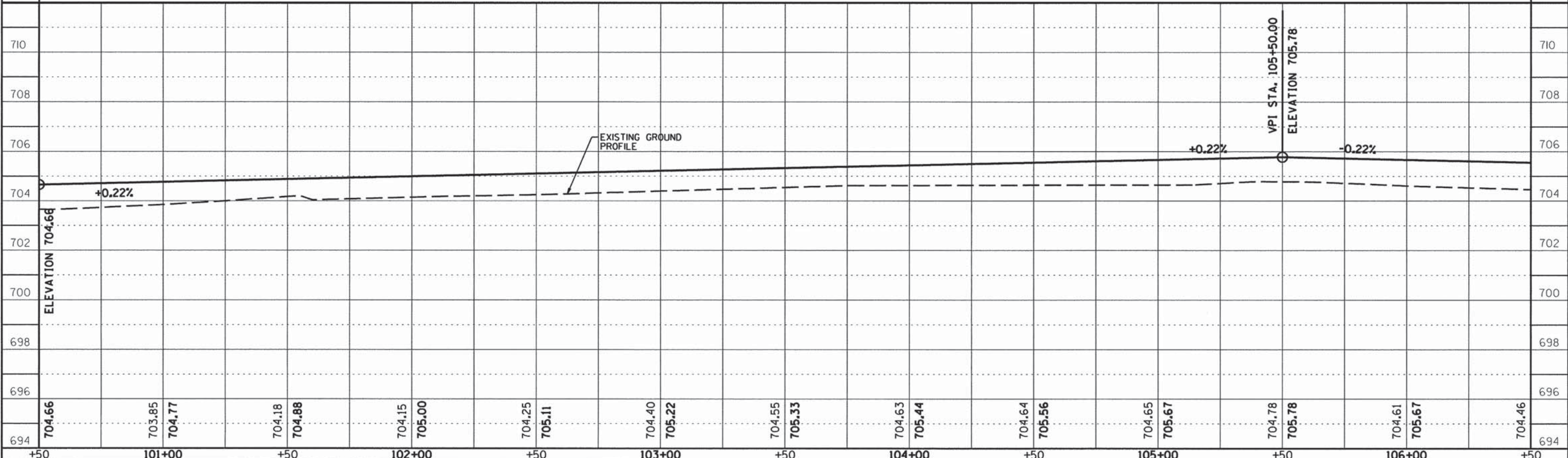
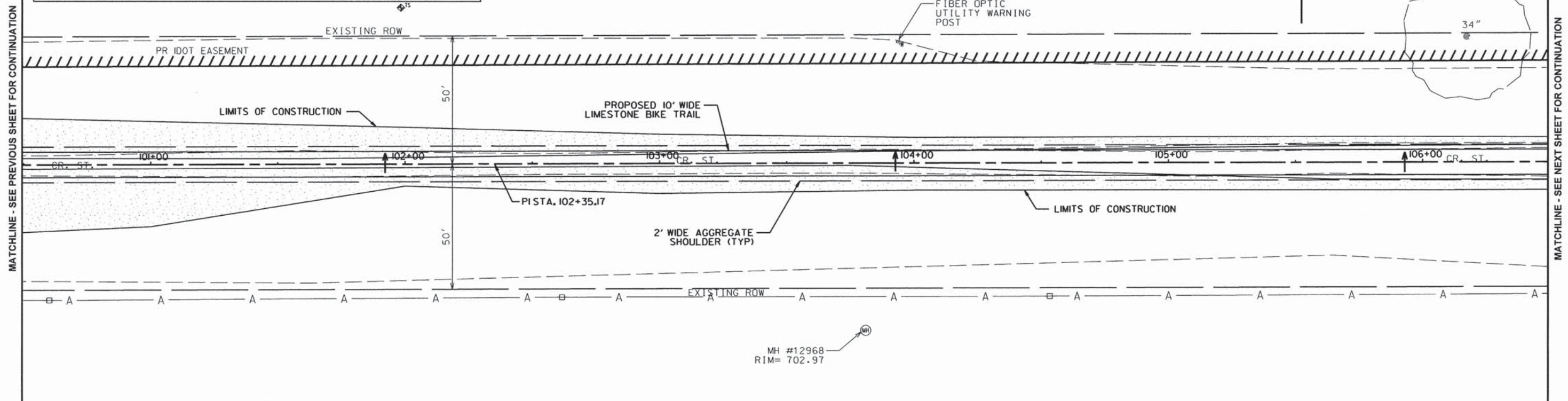
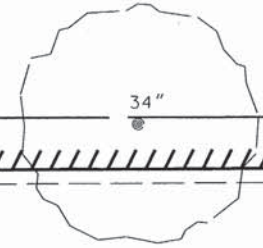

CONTRACT NO. 91520

ROUTE NO.	SECTION	COUNTY	TOTAL SHEETS	SHEET NO.
KICKAPOO TRAIL	08-F3000-02-BT	CHAMPAIGN	262	51
STA.	TO STA.			
F.H.W.A. REG.	ILLINOIS	PROJECT		



**NOTE:**  
 IF ANY TREE OUTSIDE OF THE LIMITS OF CONSTRUCTION THAT ARE ADVERSELY AFFECTED DUE TO CONSTRUCTION ACTIVITIES INCLUDING, BUT NOT LIMITED TO, ROOT DISTURBANCE, BARK REMOVAL, LIMB DAMAGE, THE TREE SHALL BE REMOVED IN ITS ENTIRETY AND HAULED OFF THE SITE AND DISPOSED OFF LEGALLY AT THE CONTRACTOR'S EXPENSE.  
 THE CONTRACTOR SHALL MAKE EVERY EFFORT TO LIMIT HIS OPERATIONS WITHIN THE DESIGNATED LIMITS OF CONSTRUCTION.  
 AT THE OPTION OF THE CCFP, TREES DAMAGED AND REMOVED OUTSIDE OF THE LIMITS OF CONSTRUCTION, THE COST OF REPLACING SAID TREES SHALL BE BORNE BY THE CONTRACTOR.

MH #12864  
 RIM= 702.40  
 12" RCP  
 IE. S. = 699.86  
 IE. N. = 702.39

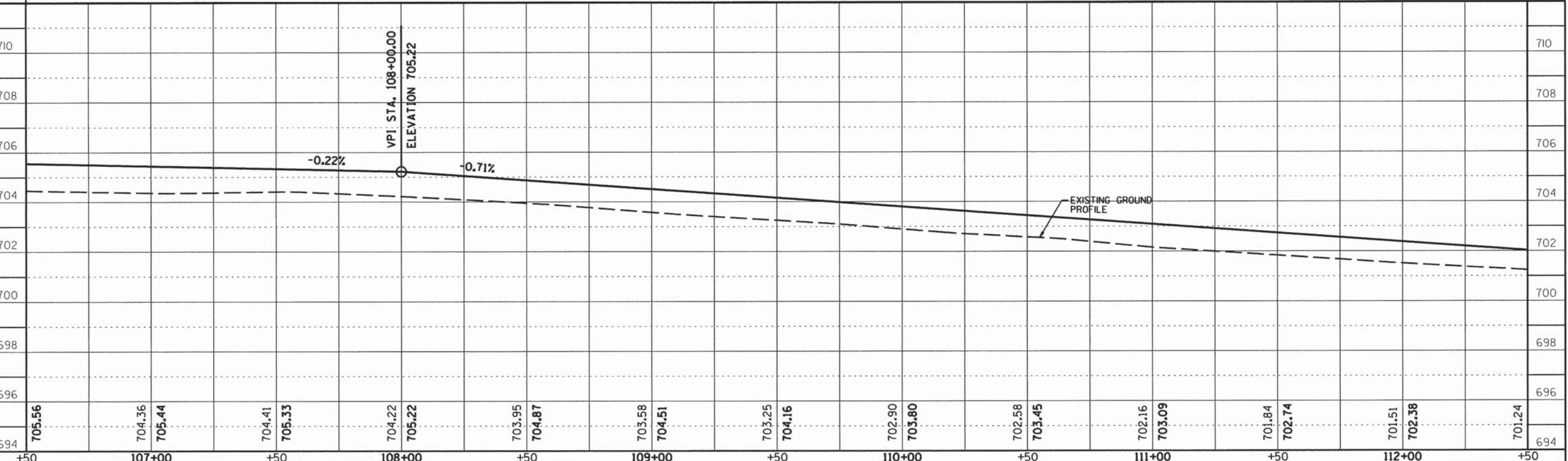
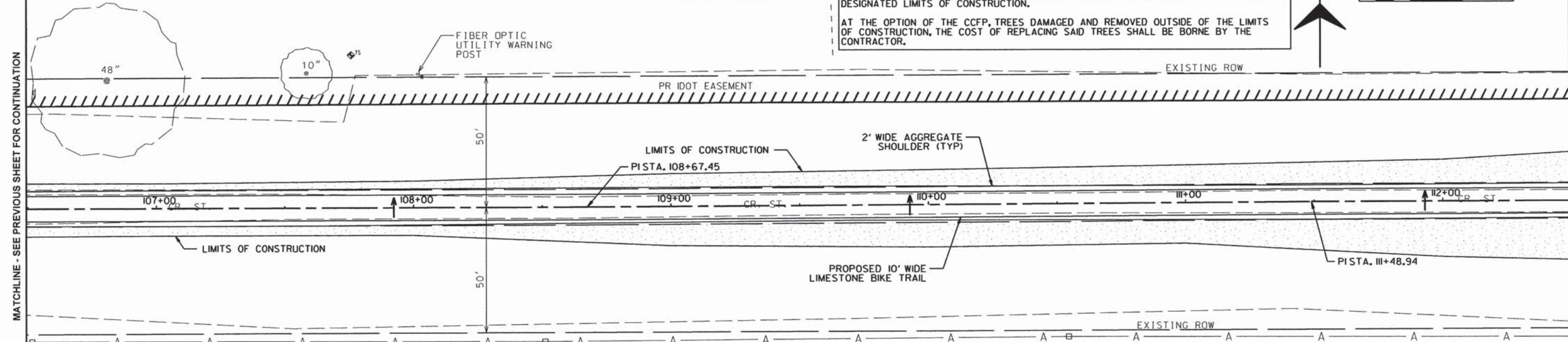



CONTRACT NO. 91520

ROUTE NO.	SECTION	COUNTY	TOTAL SHEETS	SHEET NO.
KICKAPOO TRAIL	08-F3000-02-BT	CHAMPAIGN	262	52
STA. TO STA.		ILLINOIS PROJECT		
F.U.W.A. REG.		ILLINOIS PROJECT		



**NOTE:**  
 IF ANY TREE OUTSIDE OF THE LIMITS OF CONSTRUCTION THAT ARE ADVERSELY AFFECTED DUE TO CONSTRUCTION ACTIVITIES INCLUDING, BUT NOT LIMITED TO, ROOT DISTURBANCE, BARK REMOVAL, LIMB DAMAGE, THE TREE SHALL BE REMOVED IN ITS ENTIRETY AND HAULED OFF THE SITE AND DISPOSED OFF LEGALLY AT THE CONTRACTOR'S EXPENSE.  
 THE CONTRACTOR SHALL MAKE EVERY EFFORT TO LIMIT HIS OPERATIONS WITHIN THE DESIGNATED LIMITS OF CONSTRUCTION.  
 AT THE OPTION OF THE CCFP, TREES DAMAGED AND REMOVED OUTSIDE OF THE LIMITS OF CONSTRUCTION, THE COST OF REPLACING SAID TREES SHALL BE BORNE BY THE CONTRACTOR.

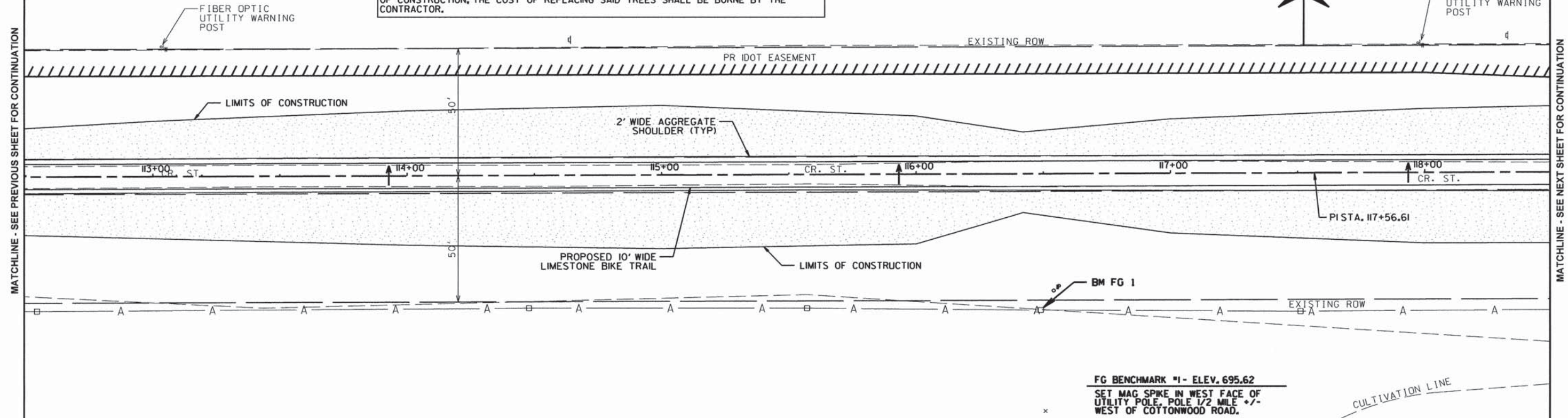

**FG BENCHMARK #1 - ELEV. 695.62**  
 SET MAG SPIKE IN WEST FACE OF UTILITY POLE, POLE 1/2 MILE +/- WEST OF COTTONWOOD ROAD.

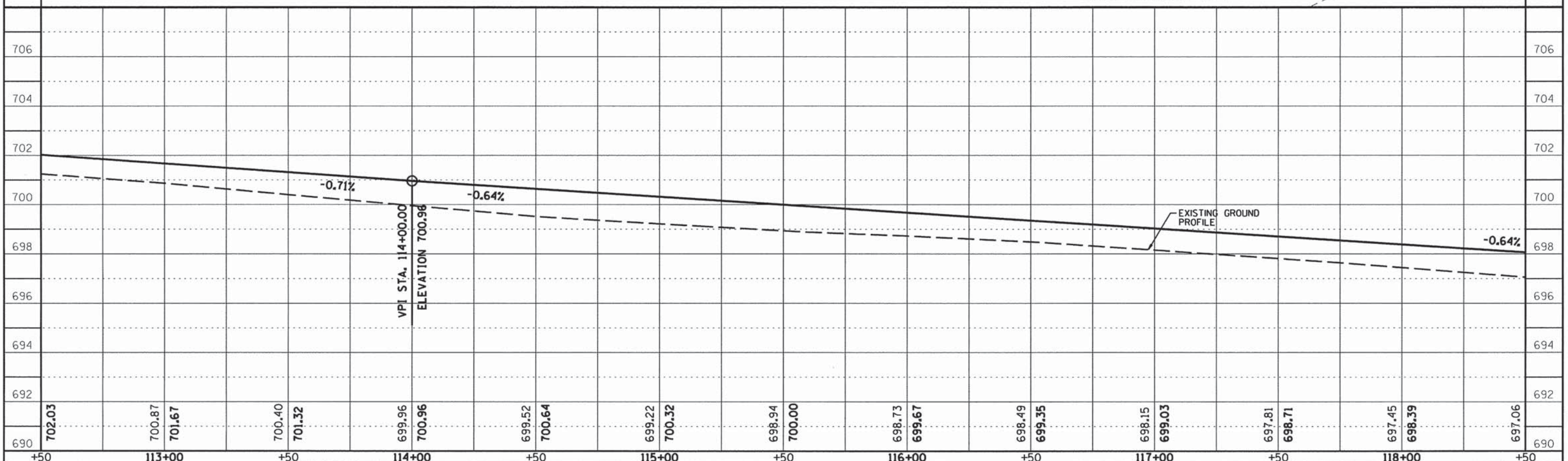

CONTRACT NO. 91520

ROUTE NO.	SECTION	COUNTY	TOTAL SHEETS	SHEET NO.
KICKAPOO TRAIL	08-F3000-02-BT	CHAMPAIGN	262	53
STA.	TO STA.			
F.H.W.A. REG.	ILLINOIS	PROJECT		



**NOTE:**  
 IF ANY TREE OUTSIDE OF THE LIMITS OF CONSTRUCTION THAT ARE ADVERSELY AFFECTED DUE TO CONSTRUCTION ACTIVITIES INCLUDING, BUT NOT LIMITED TO, ROOT DISTURBANCE, BARK REMOVAL, LIMB DAMAGE, THE TREE SHALL BE REMOVED IN ITS ENTIRETY AND HAULED OFF THE SITE AND DISPOSED OFF LEGALLY AT THE CONTRACTOR'S EXPENSE.  
 THE CONTRACTOR SHALL MAKE EVERY EFFORT TO LIMIT HIS OPERATIONS WITHIN THE DESIGNATED LIMITS OF CONSTRUCTION.  
 AT THE OPTION OF THE CCFP, TREES DAMAGED AND REMOVED OUTSIDE OF THE LIMITS OF CONSTRUCTION, THE COST OF REPLACING SAID TREES SHALL BE BORNE BY THE CONTRACTOR.

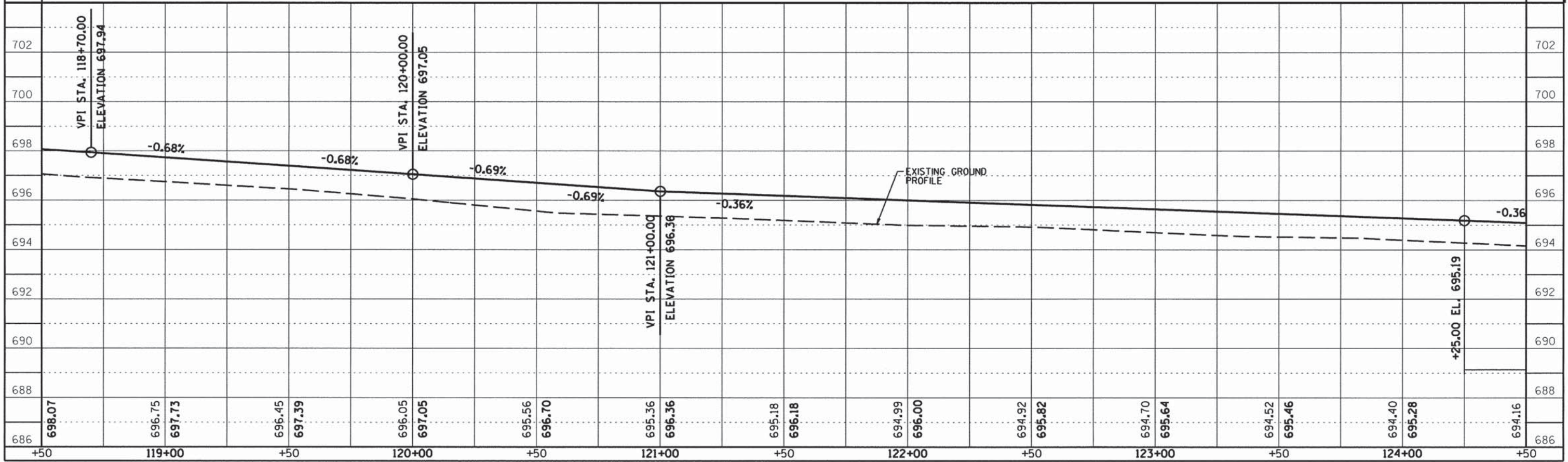
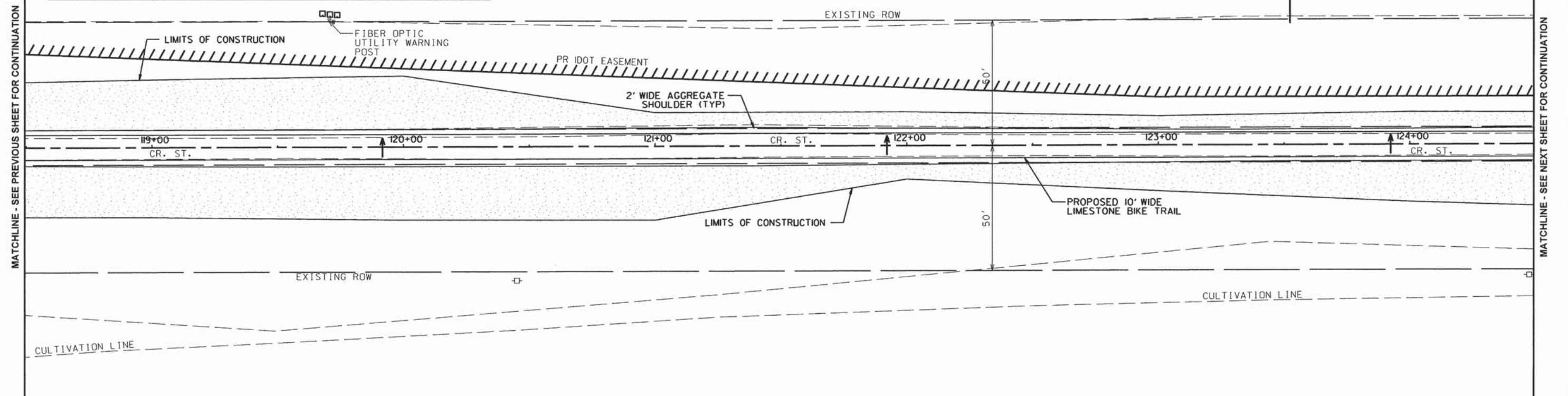

CONTRACT NO. 91520

ROUTE NO.	SECTION	COUNTY	TOTAL SHEETS	SHEET NO.
KICKAPOO TRAIL	08-F3000-02-BT	CHAMPAIGN	262	54
STA.	TO STA.			
F.H.W.A. REG.	ILLINOIS	PROJECT		



**NOTE:**  
 IF ANY TREE OUTSIDE OF THE LIMITS OF CONSTRUCTION THAT ARE ADVERSELY AFFECTED DUE TO CONSTRUCTION ACTIVITIES INCLUDING, BUT NOT LIMITED TO, ROOT DISTURBANCE, BARK REMOVAL, LIMB DAMAGE, THE TREE SHALL BE REMOVED IN ITS ENTIRETY AND HAULED OFF THE SITE AND DISPOSED OFF LEGALLY AT THE CONTRACTOR'S EXPENSE.  
 THE CONTRACTOR SHALL MAKE EVERY EFFORT TO LIMIT HIS OPERATIONS WITHIN THE DESIGNATED LIMITS OF CONSTRUCTION.  
 AT THE OPTION OF THE CCFP, TREES DAMAGED AND REMOVED OUTSIDE OF THE LIMITS OF CONSTRUCTION, THE COST OF REPLACING SAID TREES SHALL BE BORNE BY THE CONTRACTOR.

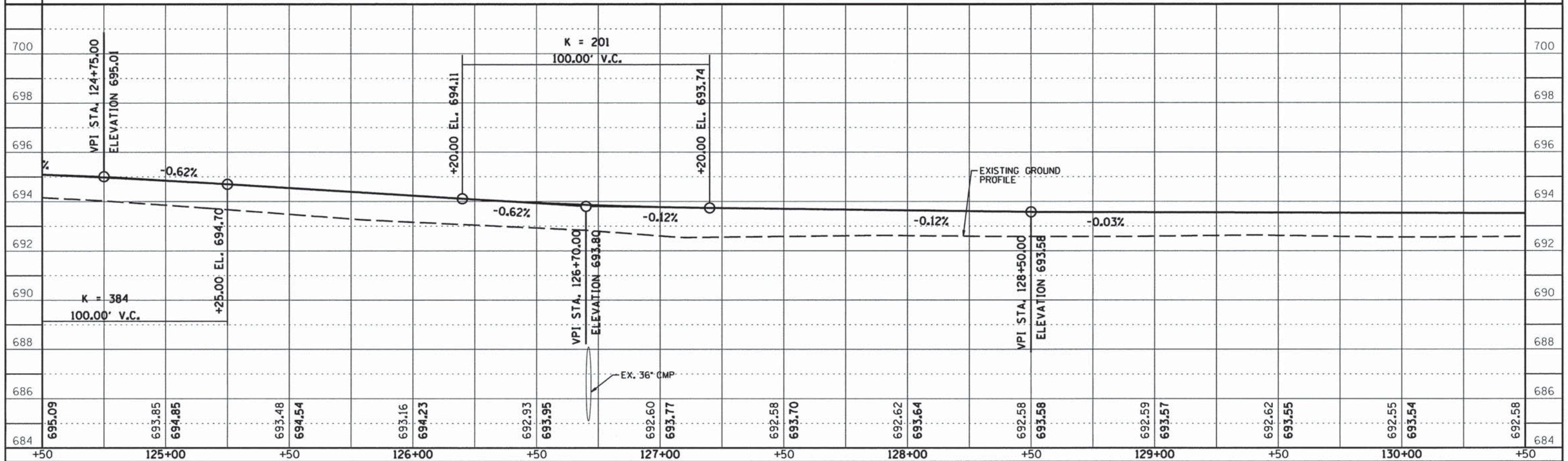
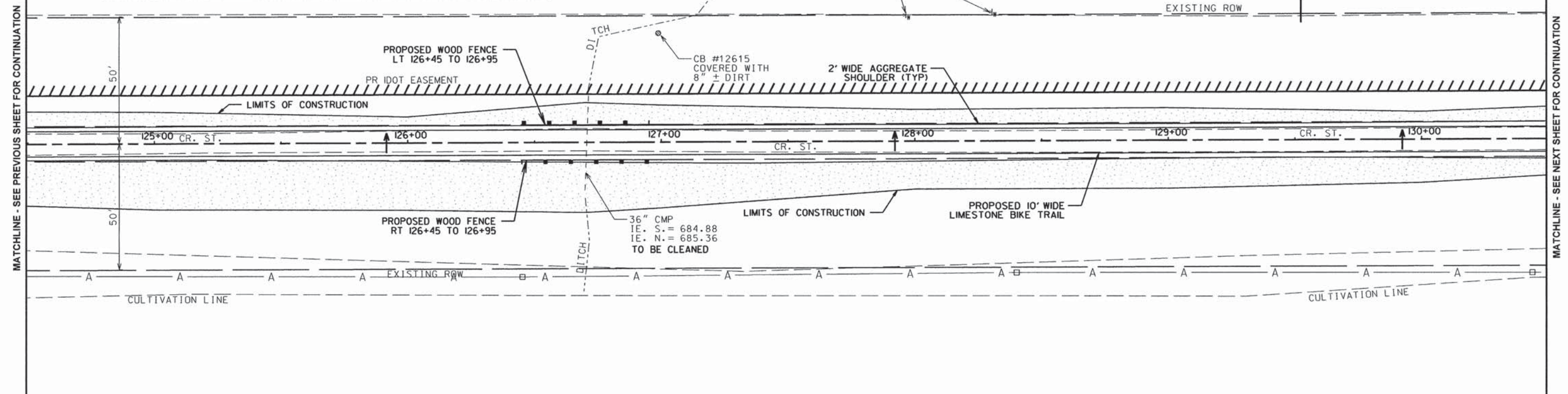

CONTRACT NO. 91520

ROUTE NO.	SECTION	COUNTY	TOTAL SHEETS	SHEET NO.
KICKAPOO TRAIL	08-F3000-02-BT	CHAMPAIGN	262	55
STA.	TO STA.			
F.H.W.A. REG.	ILLINOIS PROJECT			

**NOTE:**  
 IF ANY TREE OUTSIDE OF THE LIMITS OF CONSTRUCTION THAT ARE ADVERSELY AFFECTED DUE TO CONSTRUCTION ACTIVITIES INCLUDING, BUT NOT LIMITED TO, ROOT DISTURBANCE, BARK REMOVAL, LIMB DAMAGE, THE TREE SHALL BE REMOVED IN ITS ENTIRETY AND HAULED OFF THE SITE AND DISPOSED OFF LEGALLY AT THE CONTRACTOR'S EXPENSE.  
 THE CONTRACTOR SHALL MAKE EVERY EFFORT TO LIMIT HIS OPERATIONS WITHIN THE DESIGNATED LIMITS OF CONSTRUCTION.  
 AT THE OPTION OF THE CCFP, TREES DAMAGED AND REMOVED OUTSIDE OF THE LIMITS OF CONSTRUCTION, THE COST OF REPLACING SAID TREES SHALL BE BORNE BY THE CONTRACTOR.

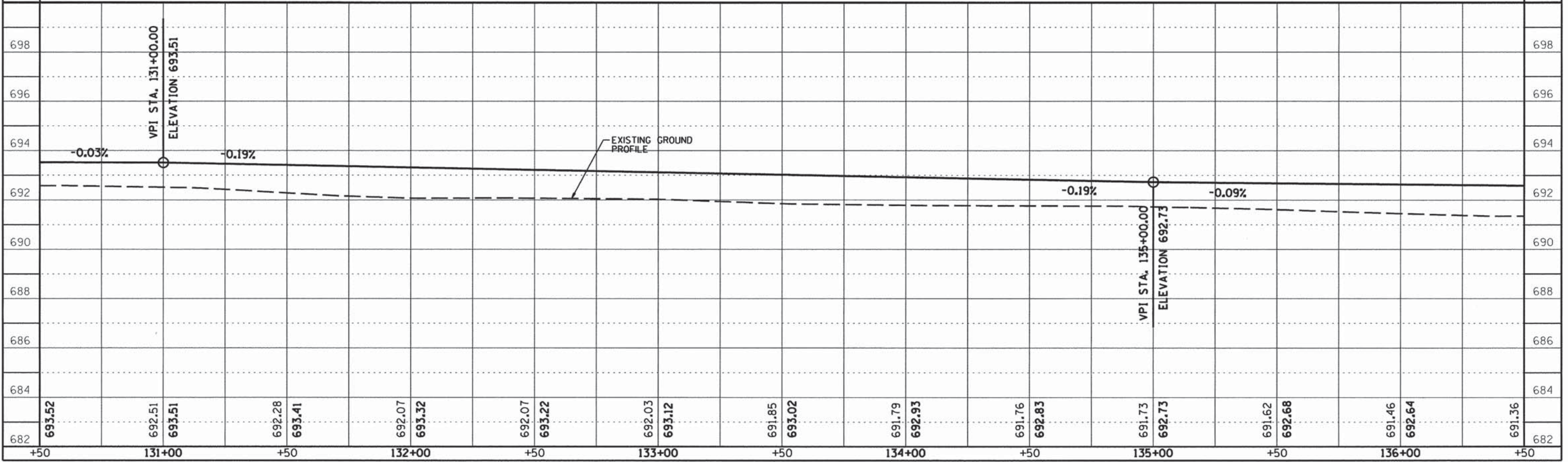
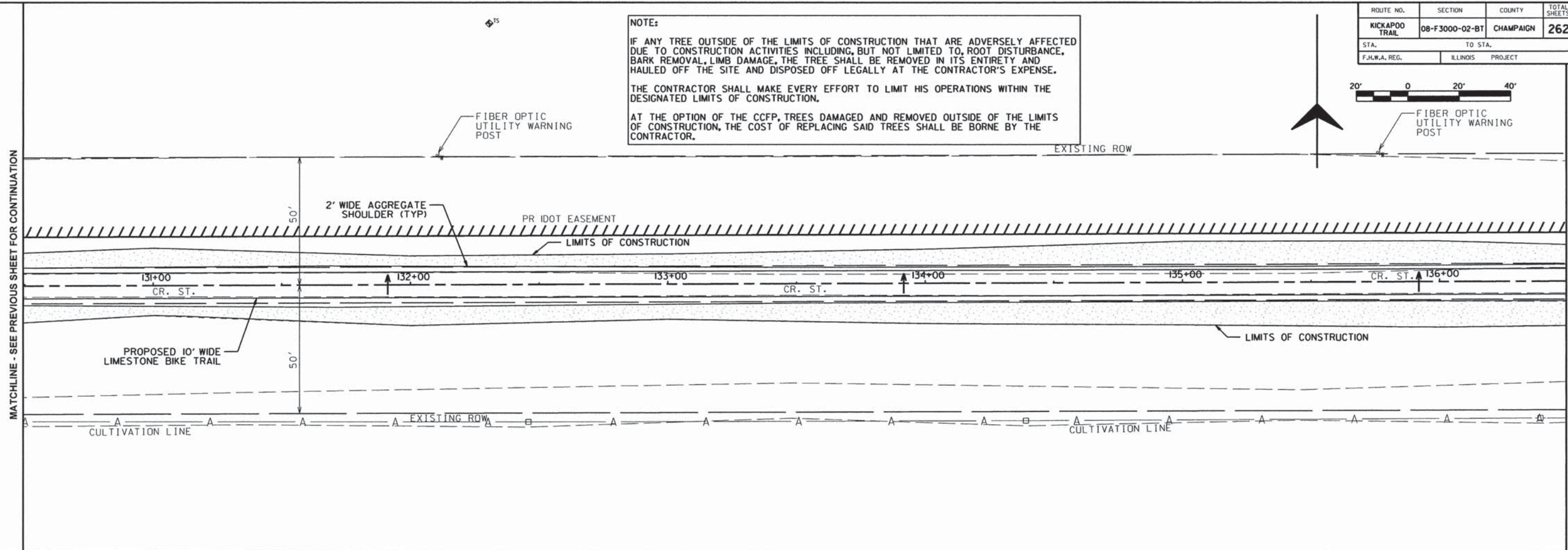

CONTRACT NO. 91520

ROUTE NO.	SECTION	COUNTY	TOTAL SHEETS	SHEET NO.
KICKAPOO TRAIL	08-F3000-02-BT	CHAMPAIGN	262	56
STA.	TO STA.			
F.H.W.A. REG.	ILLINOIS	PROJECT		



**NOTE:**  
 IF ANY TREE OUTSIDE OF THE LIMITS OF CONSTRUCTION THAT ARE ADVERSELY AFFECTED DUE TO CONSTRUCTION ACTIVITIES INCLUDING, BUT NOT LIMITED TO, ROOT DISTURBANCE, BARK REMOVAL, LIMB DAMAGE, THE TREE SHALL BE REMOVED IN ITS ENTIRETY AND HAULED OFF THE SITE AND DISPOSED OFF LEGALLY AT THE CONTRACTOR'S EXPENSE.  
 THE CONTRACTOR SHALL MAKE EVERY EFFORT TO LIMIT HIS OPERATIONS WITHIN THE DESIGNATED LIMITS OF CONSTRUCTION.  
 AT THE OPTION OF THE CCFP, TREES DAMAGED AND REMOVED OUTSIDE OF THE LIMITS OF CONSTRUCTION, THE COST OF REPLACING SAID TREES SHALL BE BORNE BY THE CONTRACTOR.

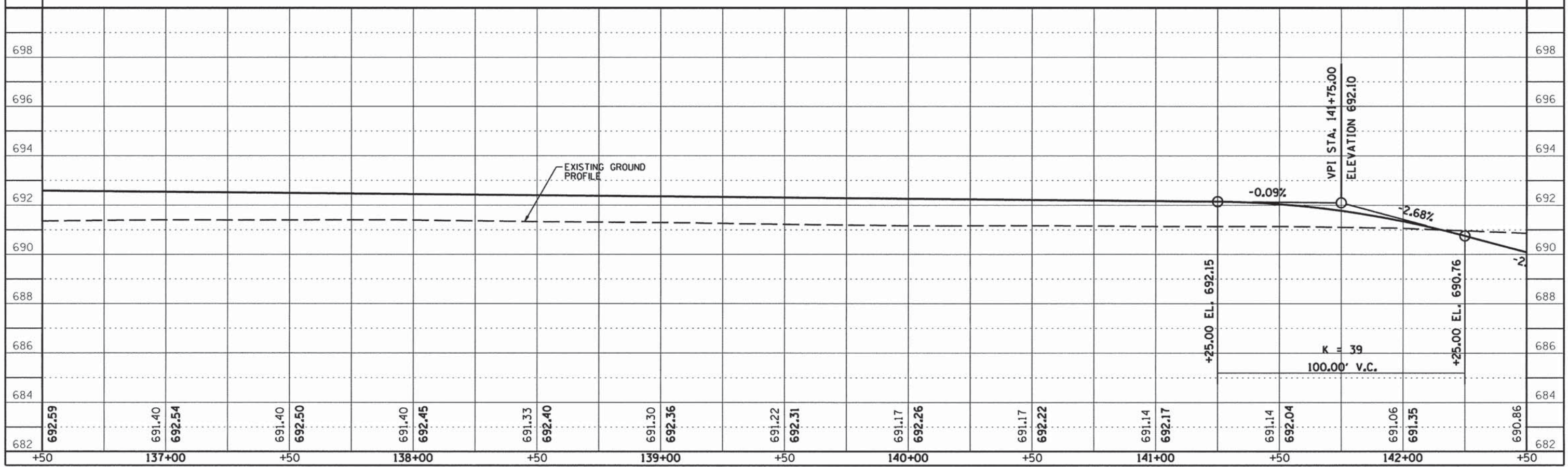
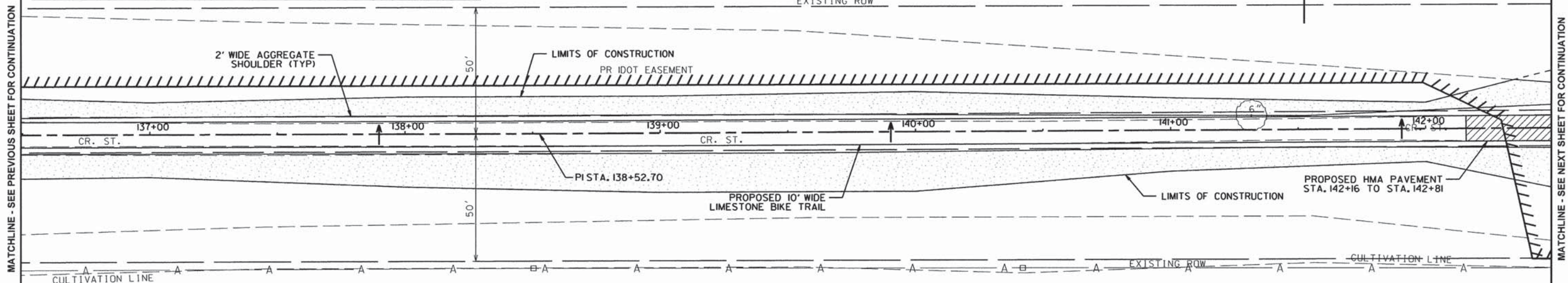

CONTRACT NO. 91520

ROUTE NO.	SECTION	COUNTY	TOTAL SHEETS	SHEET NO.
KICKAPOO TRAIL	08-F3000-02-BT	CHAMPAIGN	262	57
STA.	TO STA.			
F.H.W.A. REG.	ILLINOIS	PROJECT		

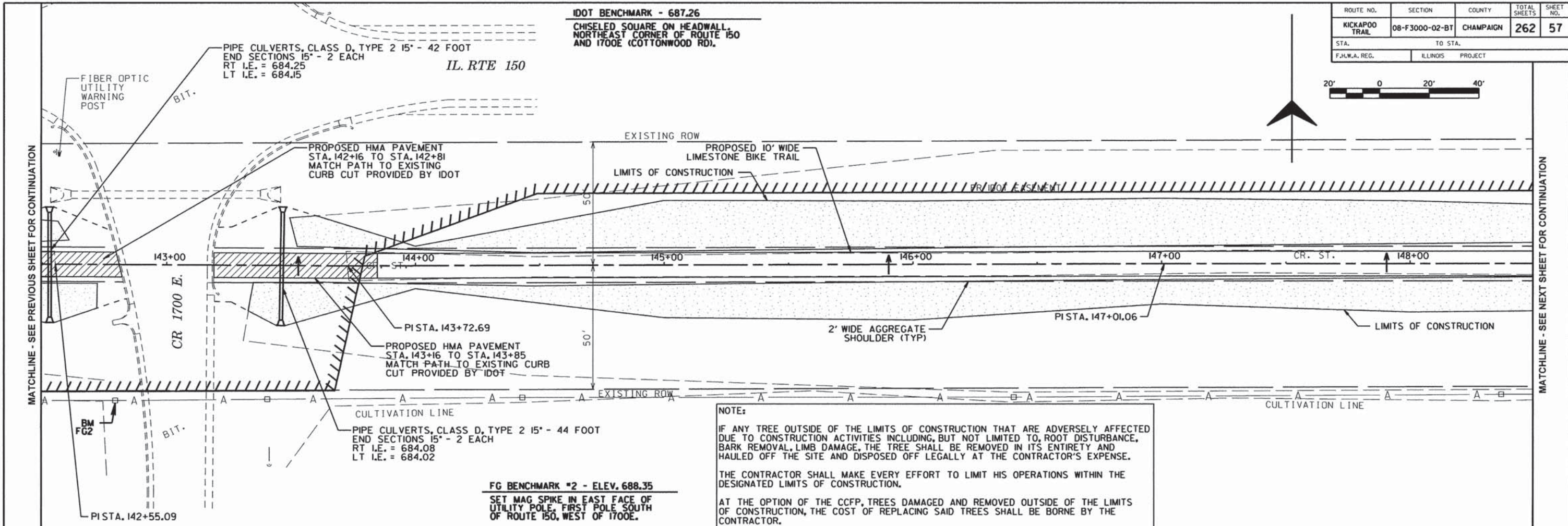

**NOTE:**  
 IF ANY TREE OUTSIDE OF THE LIMITS OF CONSTRUCTION THAT ARE ADVERSELY AFFECTED DUE TO CONSTRUCTION ACTIVITIES INCLUDING, BUT NOT LIMITED TO, ROOT DISTURBANCE, BARK REMOVAL, LIMB DAMAGE, THE TREE SHALL BE REMOVED IN ITS ENTIRETY AND HAULED OFF THE SITE AND DISPOSED OFF LEGALLY AT THE CONTRACTOR'S EXPENSE.  
 THE CONTRACTOR SHALL MAKE EVERY EFFORT TO LIMIT HIS OPERATIONS WITHIN THE DESIGNATED LIMITS OF CONSTRUCTION.  
 AT THE OPTION OF THE CCFP, TREES DAMAGED AND REMOVED OUTSIDE OF THE LIMITS OF CONSTRUCTION, THE COST OF REPLACING SAID TREES SHALL BE BORNE BY THE CONTRACTOR.

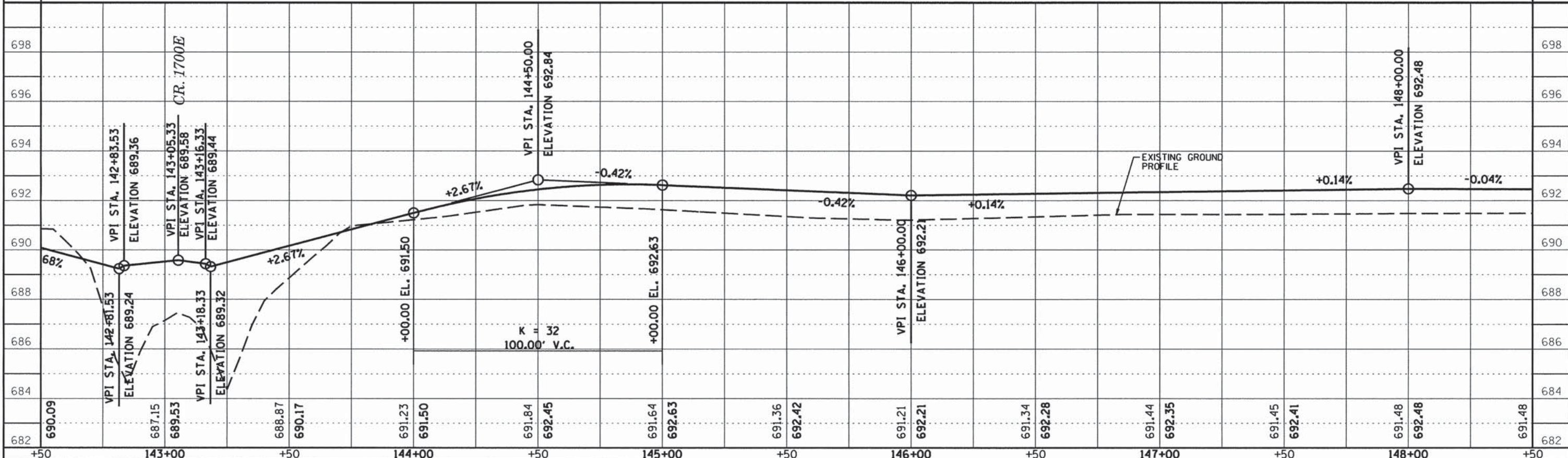

CONTRACT NO. 91520

ROUTE NO.	SECTION	COUNTY	TOTAL SHEETS	SHEET NO.
KICKAPOO TRAIL	08-F3000-02-BT	CHAMPAIGN	262	58
STA.	TO STA.			
F.J.W.A. REG.	ILLINOIS PROJECT			

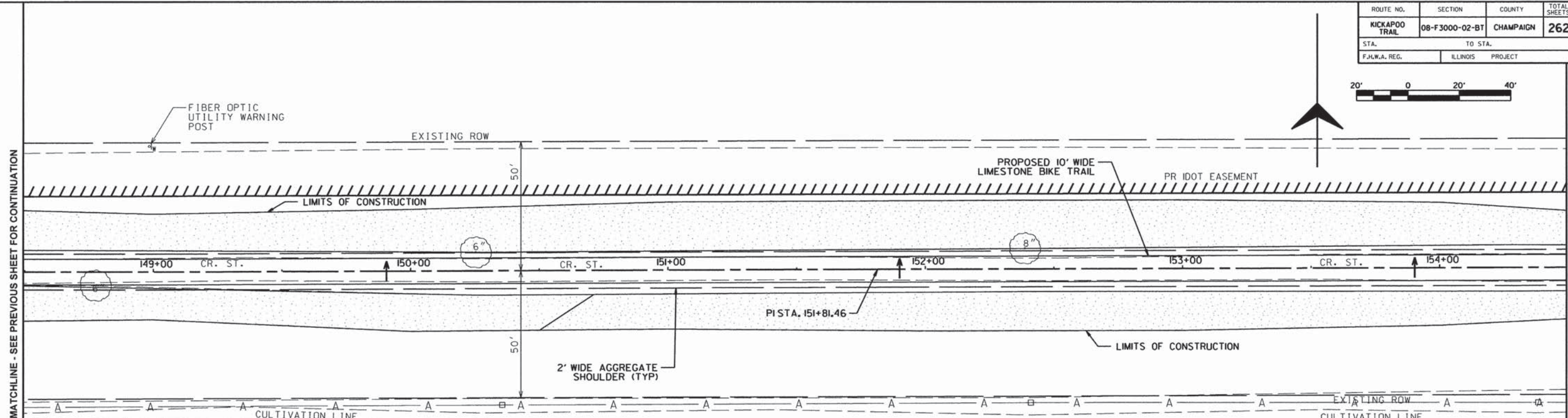

**NOTE:**  
 IF ANY TREE OUTSIDE OF THE LIMITS OF CONSTRUCTION THAT ARE ADVERSELY AFFECTED DUE TO CONSTRUCTION ACTIVITIES INCLUDING, BUT NOT LIMITED TO, ROOT DISTURBANCE, BARK REMOVAL, LIMB DAMAGE, THE TREE SHALL BE REMOVED IN ITS ENTIRETY AND HAULED OFF THE SITE AND DISPOSED OFF LEGALLY AT THE CONTRACTOR'S EXPENSE.  
 THE CONTRACTOR SHALL MAKE EVERY EFFORT TO LIMIT HIS OPERATIONS WITHIN THE DESIGNATED LIMITS OF CONSTRUCTION.  
 AT THE OPTION OF THE CCFP, TREES DAMAGED AND REMOVED OUTSIDE OF THE LIMITS OF CONSTRUCTION, THE COST OF REPLACING SAID TREES SHALL BE BORNE BY THE CONTRACTOR.

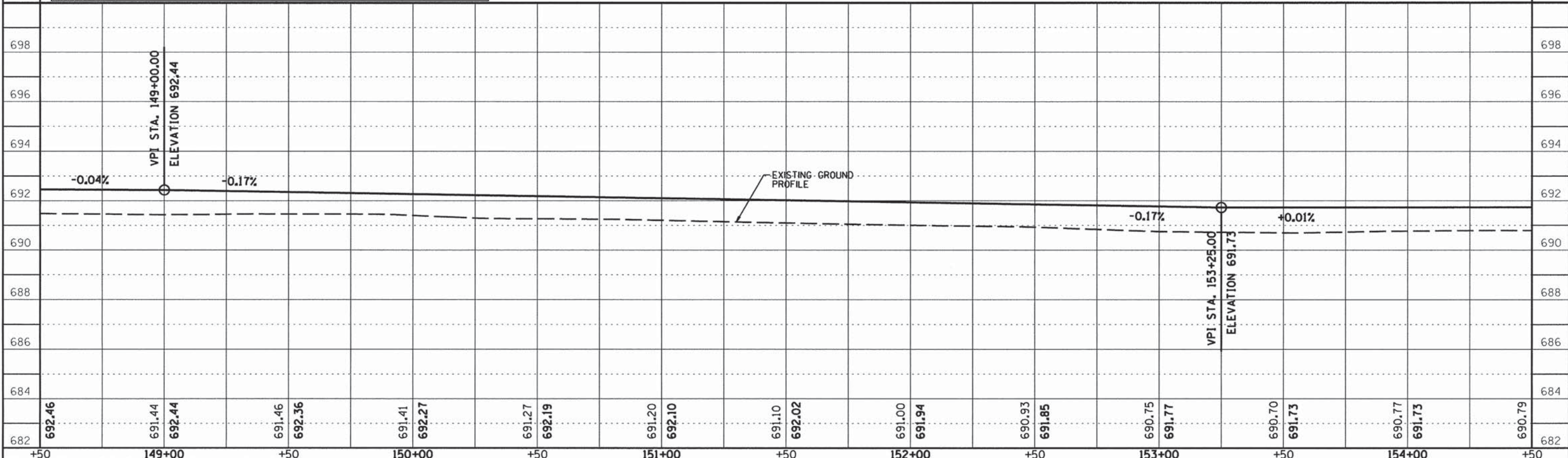

CONTRACT NO. 91520

ROUTE NO.	SECTION	COUNTY	TOTAL SHEETS	SHEET NO.
KICKAPOO TRAIL	08-F3000-02-BT	CHAMPAIGN	262	59
STA.	TO STA.			
F.H.W.A. REG.	ILLINOIS	PROJECT		



**NOTE:**  
 IF ANY TREE OUTSIDE OF THE LIMITS OF CONSTRUCTION THAT ARE ADVERSELY AFFECTED DUE TO CONSTRUCTION ACTIVITIES INCLUDING, BUT NOT LIMITED TO, ROOT DISTURBANCE, BARK REMOVAL, LIMB DAMAGE, THE TREE SHALL BE REMOVED IN ITS ENTIRETY AND HAULED OFF THE SITE AND DISPOSED OFF LEGALLY AT THE CONTRACTOR'S EXPENSE.  
 THE CONTRACTOR SHALL MAKE EVERY EFFORT TO LIMIT HIS OPERATIONS WITHIN THE DESIGNATED LIMITS OF CONSTRUCTION.  
 AT THE OPTION OF THE CCFP, TREES DAMAGED AND REMOVED OUTSIDE OF THE LIMITS OF CONSTRUCTION, THE COST OF REPLACING SAID TREES SHALL BE BORNE BY THE CONTRACTOR.

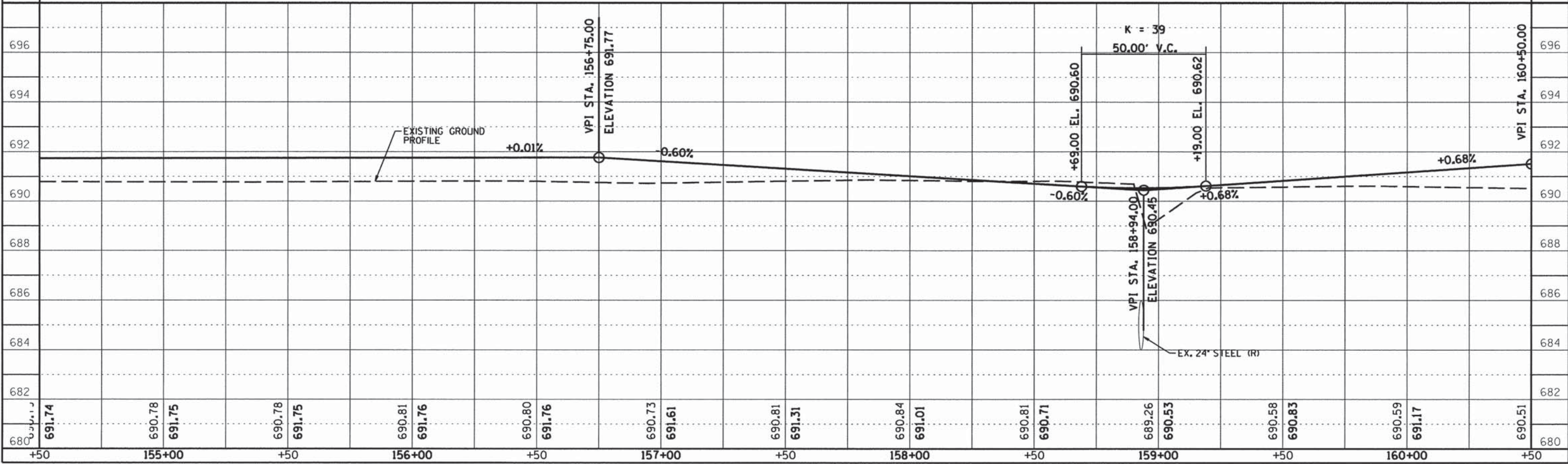
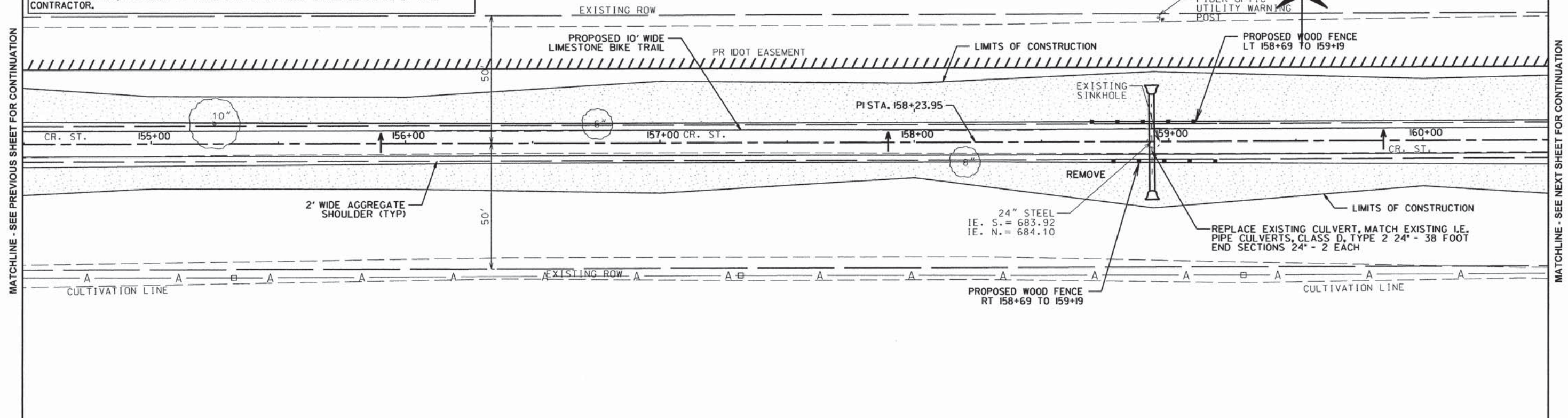



CONTRACT NO. 91520

ROUTE NO.	SECTION	COUNTY	TOTAL SHEETS	SHEET NO.
KICKAPOO TRAIL	08-F3000-02-BT	CHAMPAIGN	262	60
STA.	TO STA.			
F.H.W.A. REG.	ILLINOIS	PROJECT		

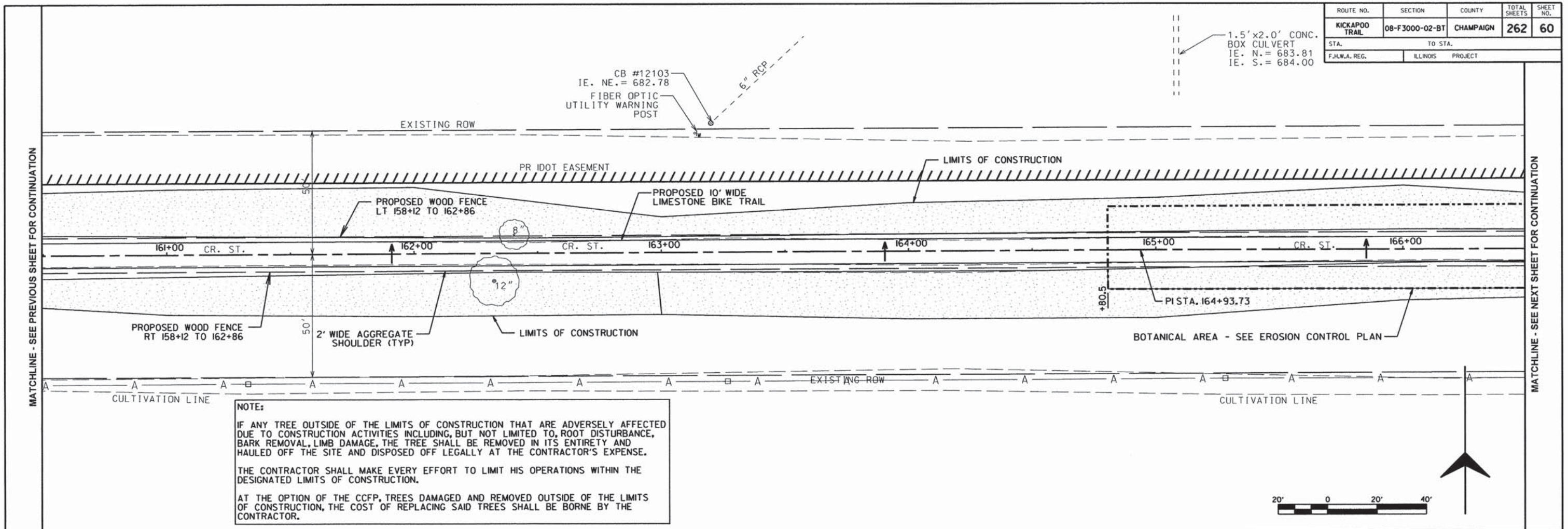

**NOTE:**  
 IF ANY TREE OUTSIDE OF THE LIMITS OF CONSTRUCTION THAT ARE ADVERSELY AFFECTED DUE TO CONSTRUCTION ACTIVITIES INCLUDING, BUT NOT LIMITED TO, ROOT DISTURBANCE, BARK REMOVAL, LIMB DAMAGE, THE TREE SHALL BE REMOVED IN ITS ENTIRETY AND HAULED OFF THE SITE AND DISPOSED OFF LEGALLY AT THE CONTRACTOR'S EXPENSE.  
 THE CONTRACTOR SHALL MAKE EVERY EFFORT TO LIMIT HIS OPERATIONS WITHIN THE DESIGNATED LIMITS OF CONSTRUCTION.  
 AT THE OPTION OF THE CCFP, TREES DAMAGED AND REMOVED OUTSIDE OF THE LIMITS OF CONSTRUCTION, THE COST OF REPLACING SAID TREES SHALL BE BORNE BY THE CONTRACTOR.

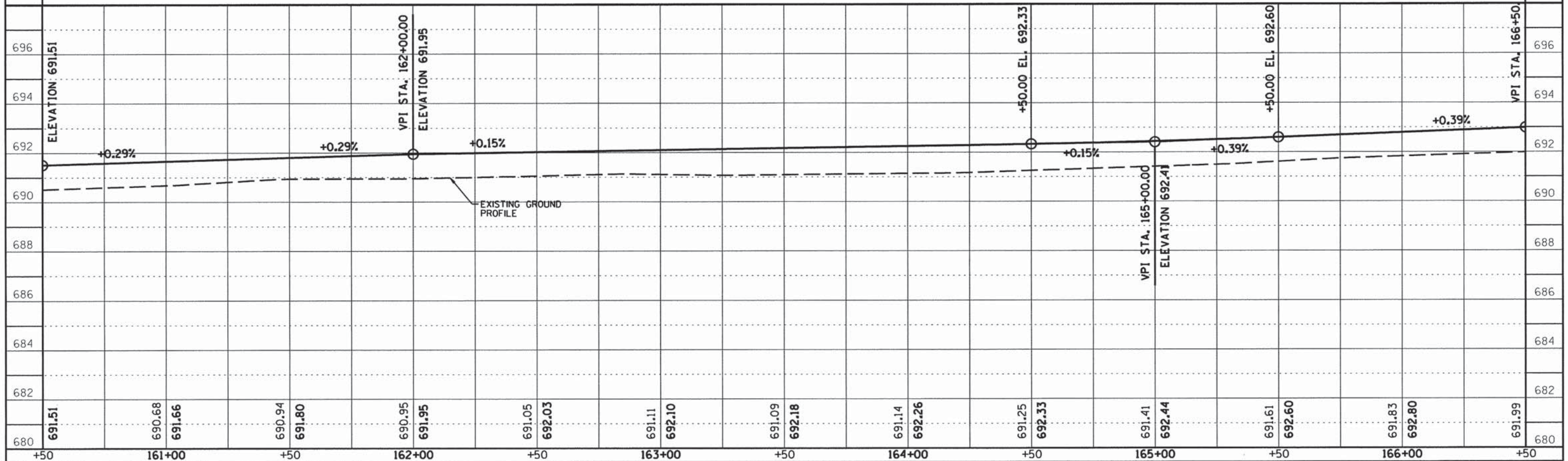

CONTRACT NO. 91520

ROUTE NO.	SECTION	COUNTY	TOTAL SHEETS	SHEET NO.
KICKAPOO TRAIL	08-F3000-02-BT	CHAMPAIGN	262	61
STA.	TO STA.			
F.H.W.A. REG.	ILLINOIS	PROJECT		

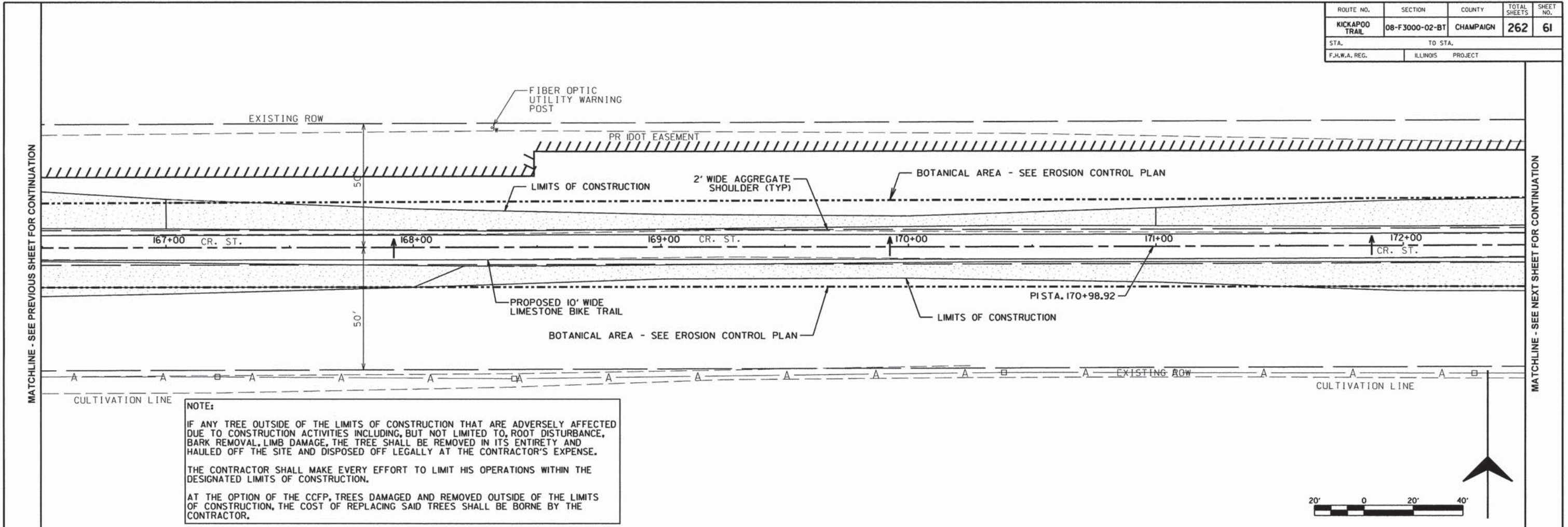

**NOTE:**  
 IF ANY TREE OUTSIDE OF THE LIMITS OF CONSTRUCTION THAT ARE ADVERSELY AFFECTED DUE TO CONSTRUCTION ACTIVITIES INCLUDING, BUT NOT LIMITED TO, ROOT DISTURBANCE, BARK REMOVAL, LIMB DAMAGE, THE TREE SHALL BE REMOVED IN ITS ENTIRETY AND HAULED OFF THE SITE AND DISPOSED OFF LEGALLY AT THE CONTRACTOR'S EXPENSE.  
 THE CONTRACTOR SHALL MAKE EVERY EFFORT TO LIMIT HIS OPERATIONS WITHIN THE DESIGNATED LIMITS OF CONSTRUCTION.  
 AT THE OPTION OF THE CCFP, TREES DAMAGED AND REMOVED OUTSIDE OF THE LIMITS OF CONSTRUCTION, THE COST OF REPLACING SAID TREES SHALL BE BORNE BY THE CONTRACTOR.

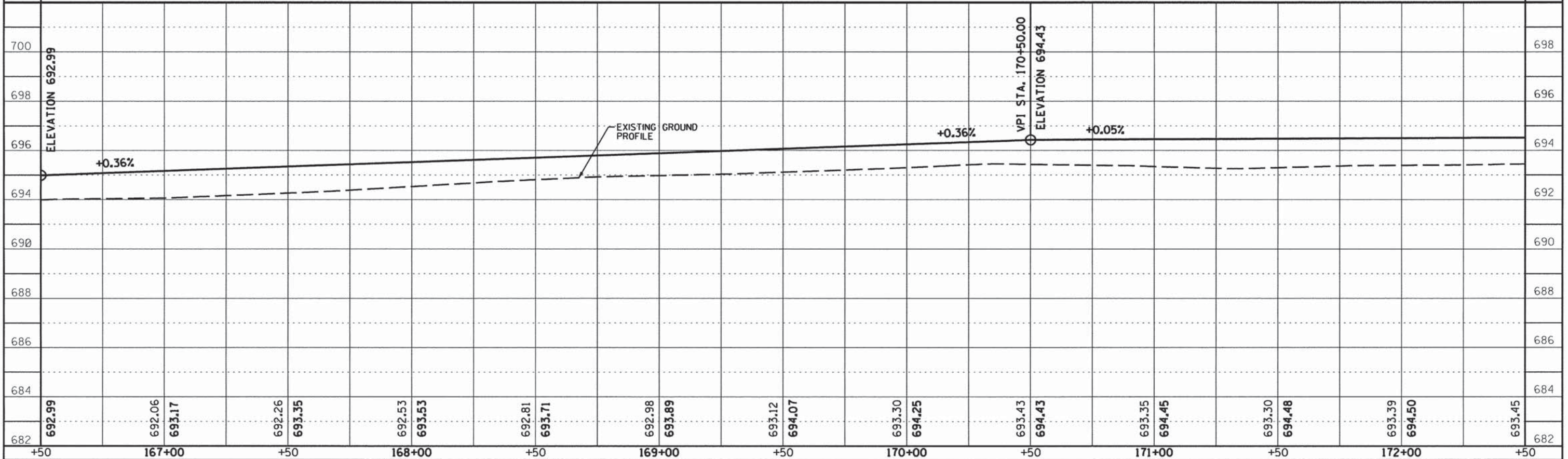

CONTRACT NO. 91520

ROUTE NO.	SECTION	COUNTY	TOTAL SHEETS	SHEET NO.
KICKAPOO TRAIL	08-F3000-02-BT	CHAMPAIGN	262	62
STA.	TO STA.			
F.H.W.A. REG.	ILLINOIS	PROJECT		

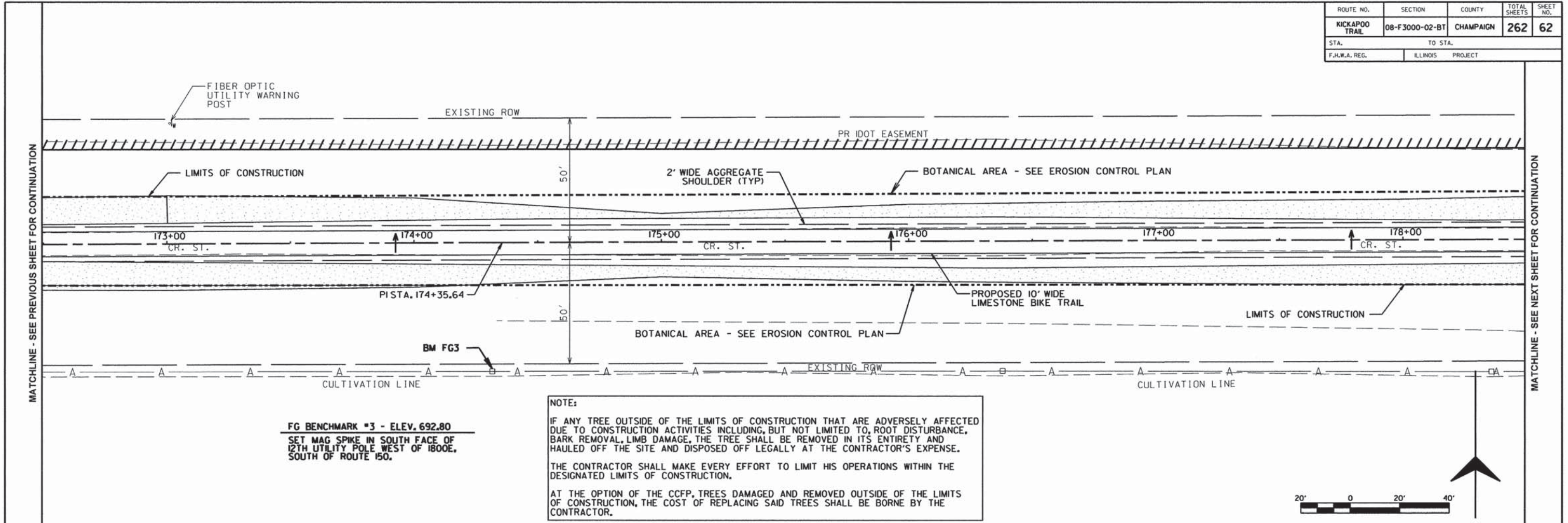

**FG BENCHMARK #3 - ELEV. 692.80**  
 SET MAG SPIKE IN SOUTH FACE OF 12TH UTILITY POLE WEST OF 1800E, SOUTH OF ROUTE 150.

**NOTE:**  
 IF ANY TREE OUTSIDE OF THE LIMITS OF CONSTRUCTION THAT ARE ADVERSELY AFFECTED DUE TO CONSTRUCTION ACTIVITIES INCLUDING, BUT NOT LIMITED TO, ROOT DISTURBANCE, BARK REMOVAL, LIMB DAMAGE, THE TREE SHALL BE REMOVED IN ITS ENTIRETY AND HAULED OFF THE SITE AND DISPOSED OFF LEGALLY AT THE CONTRACTOR'S EXPENSE.  
 THE CONTRACTOR SHALL MAKE EVERY EFFORT TO LIMIT HIS OPERATIONS WITHIN THE DESIGNATED LIMITS OF CONSTRUCTION.  
 AT THE OPTION OF THE CCFP, TREES DAMAGED AND REMOVED OUTSIDE OF THE LIMITS OF CONSTRUCTION, THE COST OF REPLACING SAID TREES SHALL BE BORNE BY THE CONTRACTOR.

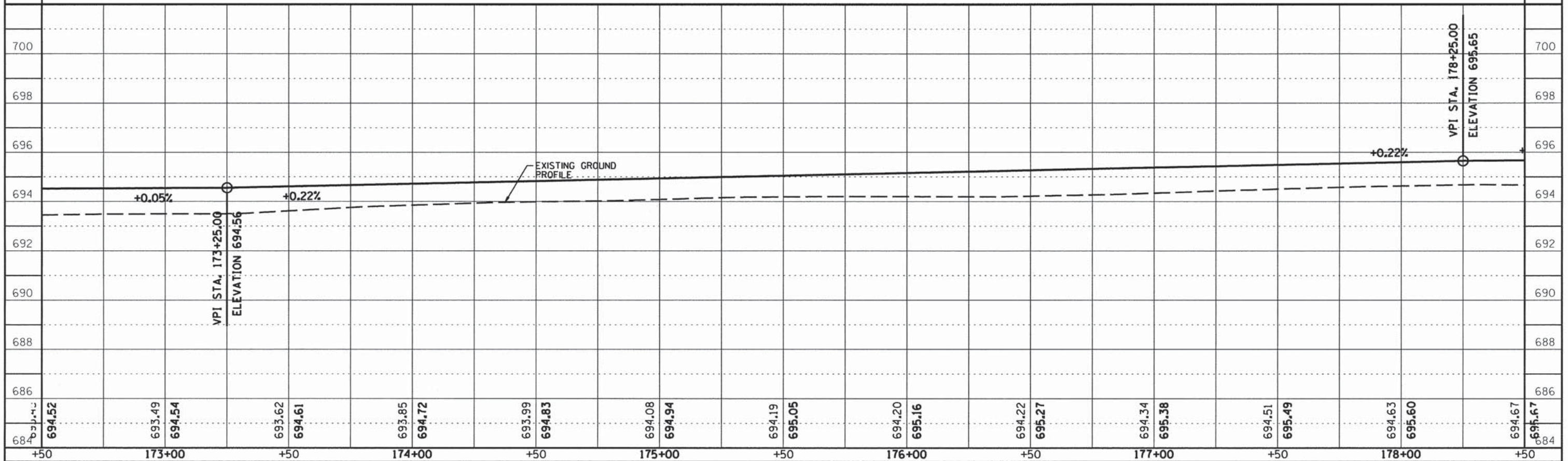

CONTRACT NO. 91520

ROUTE NO.	SECTION	COUNTY	TOTAL SHEETS	SHEET NO.
KICKAPOO TRAIL	08-F3000-02-BT	CHAMPAIGN	262	63
STA.	TO STA.			
F.H.W.A. REG.	ILLINOIS	PROJECT		



**NOTE:**  
 IF ANY TREE OUTSIDE OF THE LIMITS OF CONSTRUCTION THAT ARE ADVERSELY AFFECTED DUE TO CONSTRUCTION ACTIVITIES INCLUDING, BUT NOT LIMITED TO, ROOT DISTURBANCE, BARK REMOVAL, LIMB DAMAGE, THE TREE SHALL BE REMOVED IN ITS ENTIRETY AND HAULED OFF THE SITE AND DISPOSED OFF LEGALLY AT THE CONTRACTOR'S EXPENSE.  
 THE CONTRACTOR SHALL MAKE EVERY EFFORT TO LIMIT HIS OPERATIONS WITHIN THE DESIGNATED LIMITS OF CONSTRUCTION.  
 AT THE OPTION OF THE CCFP, TREES DAMAGED AND REMOVED OUTSIDE OF THE LIMITS OF CONSTRUCTION, THE COST OF REPLACING SAID TREES SHALL BE BORNE BY THE CONTRACTOR.

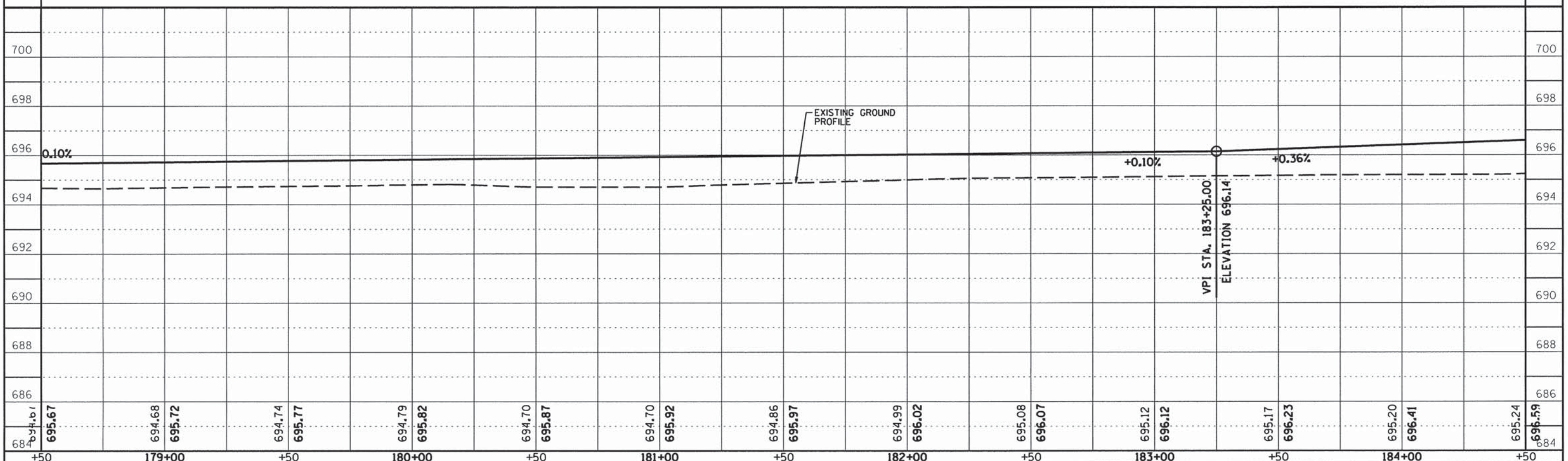
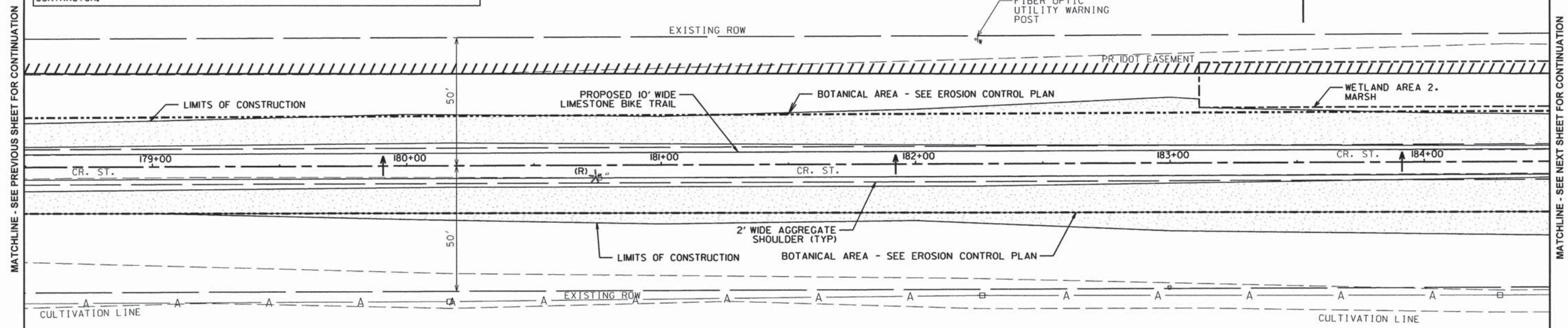

CONTRACT NO. 91520

ROUTE NO.	SECTION	COUNTY	TOTAL SHEETS	SHEET NO.
KICKAPOO TRAIL	08-F3000-02-BT	CHAMPAIGN	262	64
STA.	TO STA.			
F.H.W.A. REG.	ILLINOIS	PROJECT		

**NOTE:**  
 IF ANY TREE OUTSIDE OF THE LIMITS OF CONSTRUCTION THAT ARE ADVERSELY AFFECTED DUE TO CONSTRUCTION ACTIVITIES INCLUDING, BUT NOT LIMITED TO, ROOT DISTURBANCE, BARK REMOVAL, LIMB DAMAGE, THE TREE SHALL BE REMOVED IN ITS ENTIRETY AND HAULED OFF THE SITE AND DISPOSED OFF LEGALLY AT THE CONTRACTOR'S EXPENSE.  
 THE CONTRACTOR SHALL MAKE EVERY EFFORT TO LIMIT HIS OPERATIONS WITHIN THE DESIGNATED LIMITS OF CONSTRUCTION.  
 AT THE OPTION OF THE CCFP, TREES DAMAGED AND REMOVED OUTSIDE OF THE LIMITS OF CONSTRUCTION, THE COST OF REPLACING SAID TREES SHALL BE BORNE BY THE CONTRACTOR.

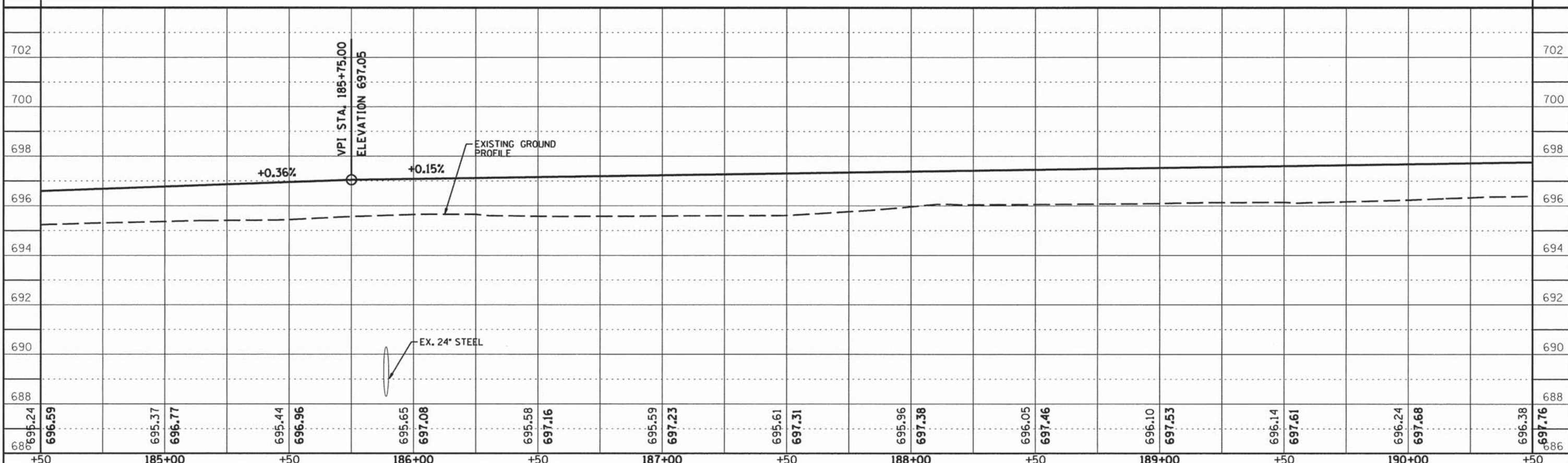
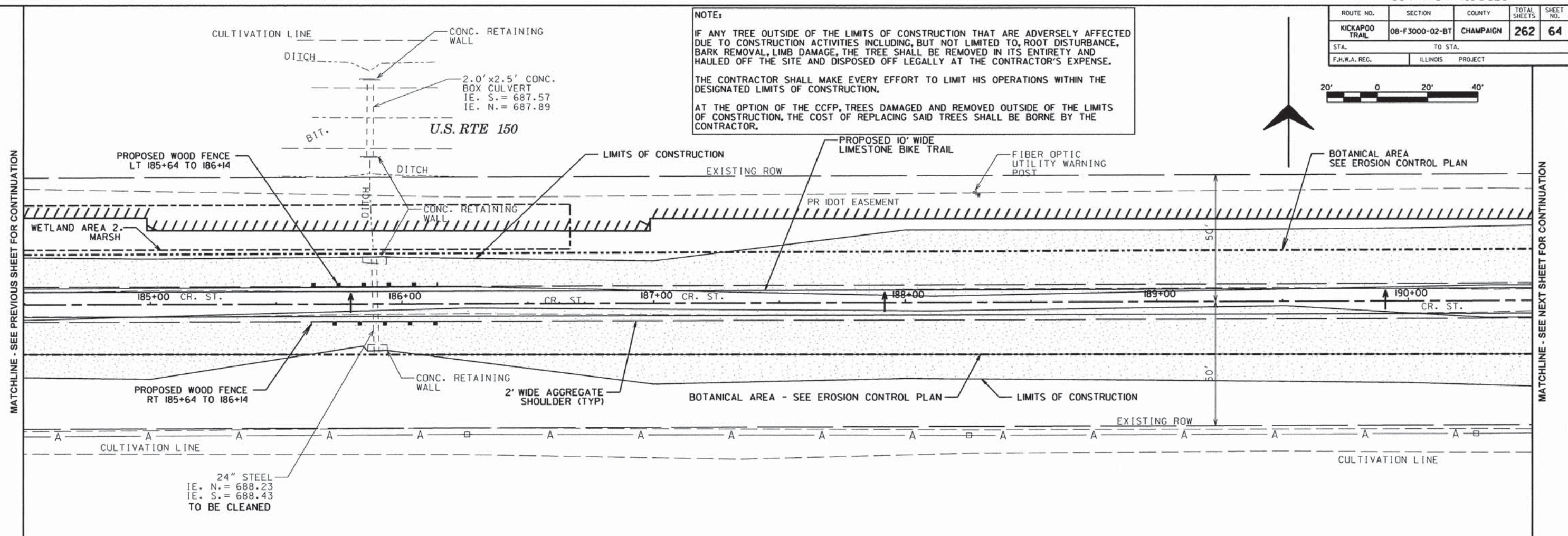

CONTRACT NO. 91520

ROUTE NO.	SECTION	COUNTY	TOTAL SHEETS	SHEET NO.
KICKAPOO TRAIL	08-F3000-02-BT	CHAMPAIGN	262	65
STA.	TO STA.			
F.H.W.A. REG.	ILLINOIS	PROJECT		

DOT BENCHMARK - ELEV. 693.61  
CHISELED SQUARE ON HEADWALL,  
NORTHWEST CORNER OF ROUTE 150  
AND CR 1800E



**NOTE:**  
IF ANY TREE OUTSIDE OF THE LIMITS OF CONSTRUCTION THAT ARE ADVERSELY AFFECTED DUE TO CONSTRUCTION ACTIVITIES INCLUDING, BUT NOT LIMITED TO, ROOT DISTURBANCE, BARK REMOVAL, LIMB DAMAGE, THE TREE SHALL BE REMOVED IN ITS ENTIRETY AND HAULED OFF THE SITE AND DISPOSED OFF LEGALLY AT THE CONTRACTOR'S EXPENSE.  
THE CONTRACTOR SHALL MAKE EVERY EFFORT TO LIMIT HIS OPERATIONS WITHIN THE DESIGNATED LIMITS OF CONSTRUCTION.  
AT THE OPTION OF THE CCFP, TREES DAMAGED AND REMOVED OUTSIDE OF THE LIMITS OF CONSTRUCTION, THE COST OF REPLACING SAID TREES SHALL BE BORNE BY THE CONTRACTOR.

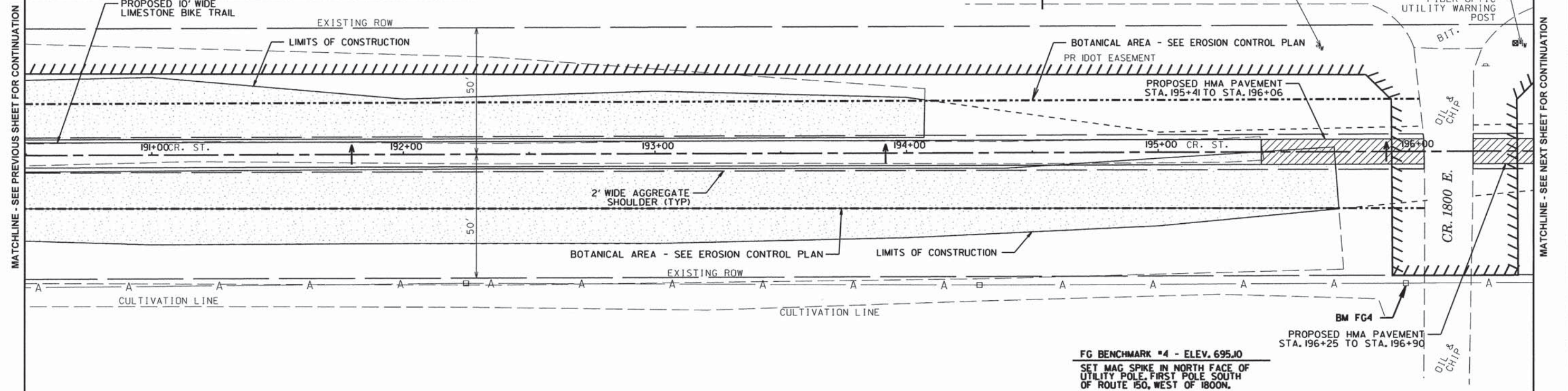

FG BENCHMARK #4 - ELEV. 695.10  
SET MAG SPIKE IN NORTH FACE OF  
UTILITY POLE, FIRST POLE SOUTH  
OF ROUTE 150, WEST OF 1800E.

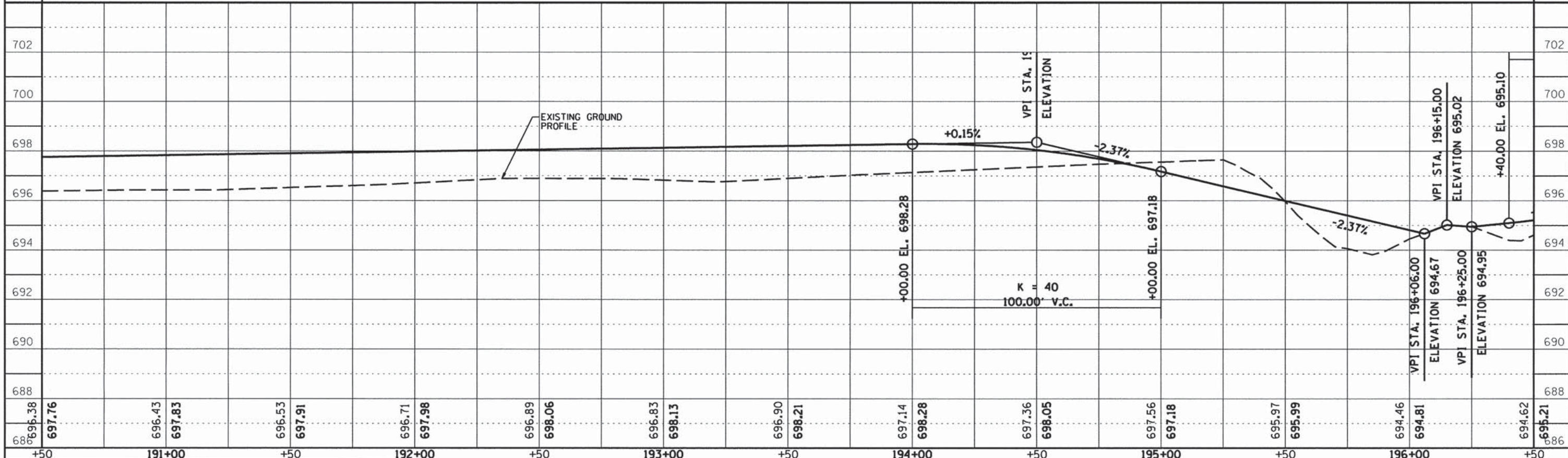

CHAMPAIGN COUNTY

KICKAPOO TRAIL - URBANA TO ST. JOSEPH

SECTION 08-F3000-02-BT

SHEET 65 OF 262 SHEETS 13-620A

CONTRACT NO. 91520

ROUTE NO.	SECTION	COUNTY	TOTAL SHEETS	SHEET NO.
KICKAPOO TRAIL	08-F3000-02-BT	CHAMPAIGN	262	66
STA.	TO STA.			
F.H.W.A. REG.	ILLINOIS	PROJECT		



FIBER OPTIC UTILITY WARNING POST

**NOTE:**  
 IF ANY TREE OUTSIDE OF THE LIMITS OF CONSTRUCTION THAT ARE ADVERSELY AFFECTED DUE TO CONSTRUCTION ACTIVITIES INCLUDING, BUT NOT LIMITED TO, ROOT DISTURBANCE, BARK REMOVAL, LIMB DAMAGE, THE TREE SHALL BE REMOVED IN ITS ENTIRETY AND HAULED OFF THE SITE AND DISPOSED OFF LEGALLY AT THE CONTRACTOR'S EXPENSE.  
 THE CONTRACTOR SHALL MAKE EVERY EFFORT TO LIMIT HIS OPERATIONS WITHIN THE DESIGNATED LIMITS OF CONSTRUCTION.  
 AT THE OPTION OF THE CCFP, TREES DAMAGED AND REMOVED OUTSIDE OF THE LIMITS OF CONSTRUCTION, THE COST OF REPLACING SAID TREES SHALL BE BORNE BY THE CONTRACTOR.

MT. OLIVE CEMETERY

U.S. RTE 150

MATCHLINE - SEE PREVIOUS SHEET FOR CONTINUATION

MATCHLINE - SEE NEXT SHEET FOR CONTINUATION

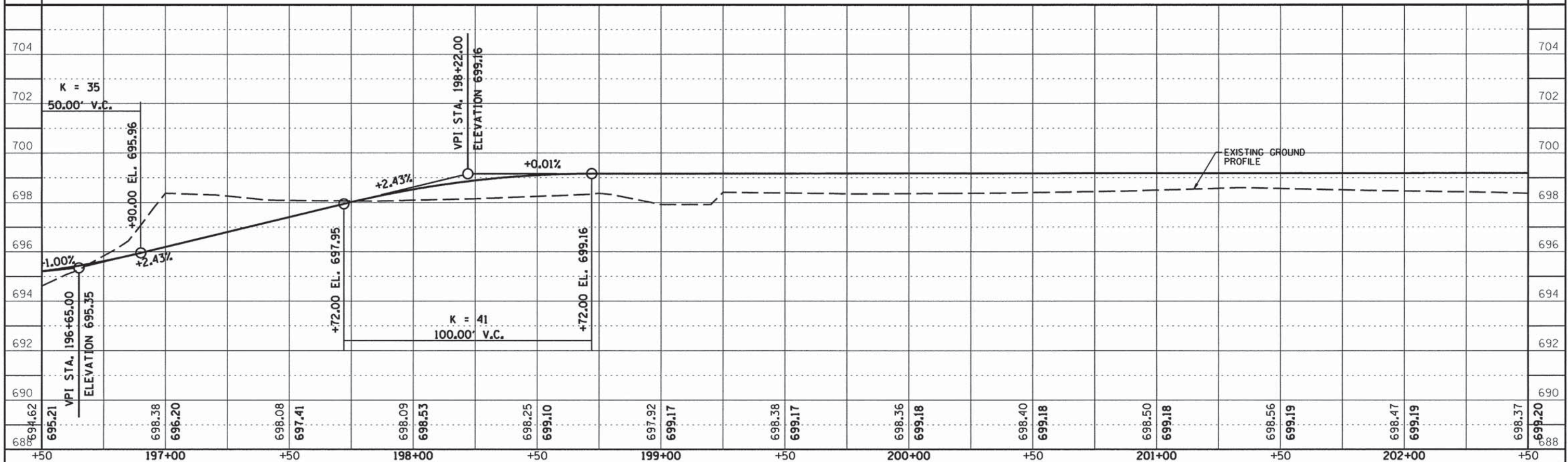
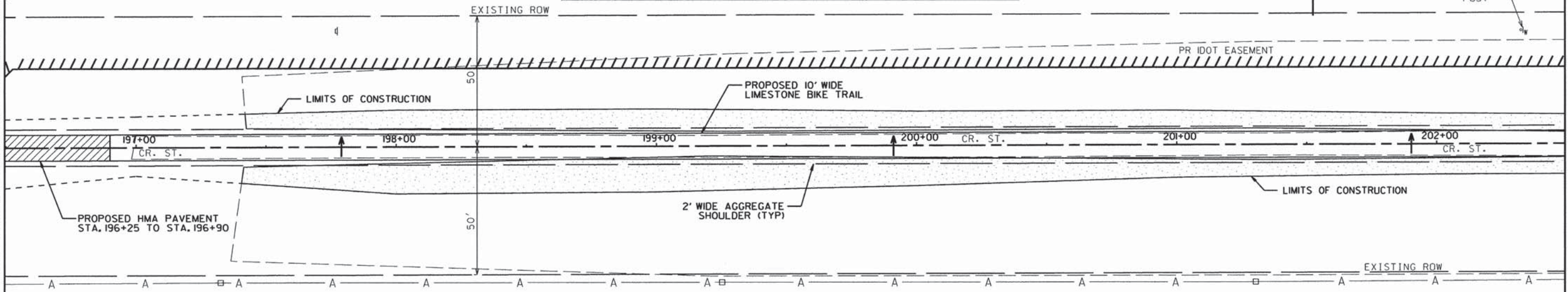

CONTRACT NO. 91520

ROUTE NO.	SECTION	COUNTY	TOTAL SHEETS	SHEET NO.
KICKAPOO TRAIL	08-F3000-02-BT	CHAMPAIGN	262	67
STA.	TO STA.			
F.J.W.A. REG.	ILLINOIS PROJECT			



**NOTE:**  
 IF ANY TREE OUTSIDE OF THE LIMITS OF CONSTRUCTION THAT ARE ADVERSELY AFFECTED DUE TO CONSTRUCTION ACTIVITIES INCLUDING, BUT NOT LIMITED TO, ROOT DISTURBANCE, BARK REMOVAL, LIMB DAMAGE, THE TREE SHALL BE REMOVED IN ITS ENTIRETY AND HAULED OFF THE SITE AND DISPOSED OFF LEGALLY AT THE CONTRACTOR'S EXPENSE.  
 THE CONTRACTOR SHALL MAKE EVERY EFFORT TO LIMIT HIS OPERATIONS WITHIN THE DESIGNATED LIMITS OF CONSTRUCTION.  
 AT THE OPTION OF THE CCFP, TREES DAMAGED AND REMOVED OUTSIDE OF THE LIMITS OF CONSTRUCTION, THE COST OF REPLACING SAID TREES SHALL BE BORNE BY THE CONTRACTOR.

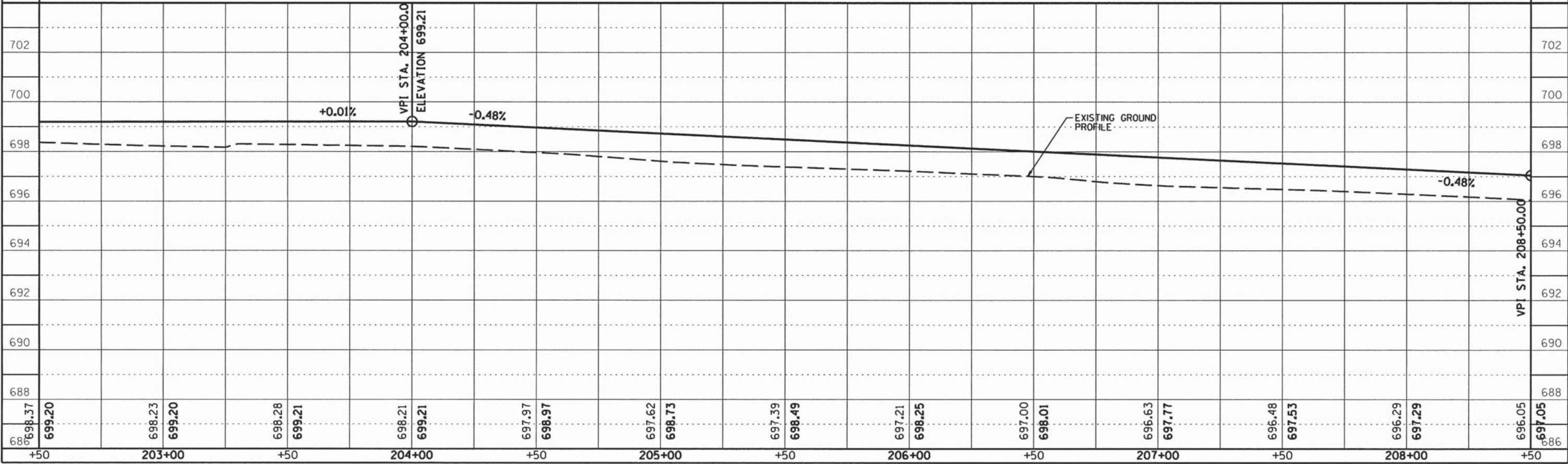
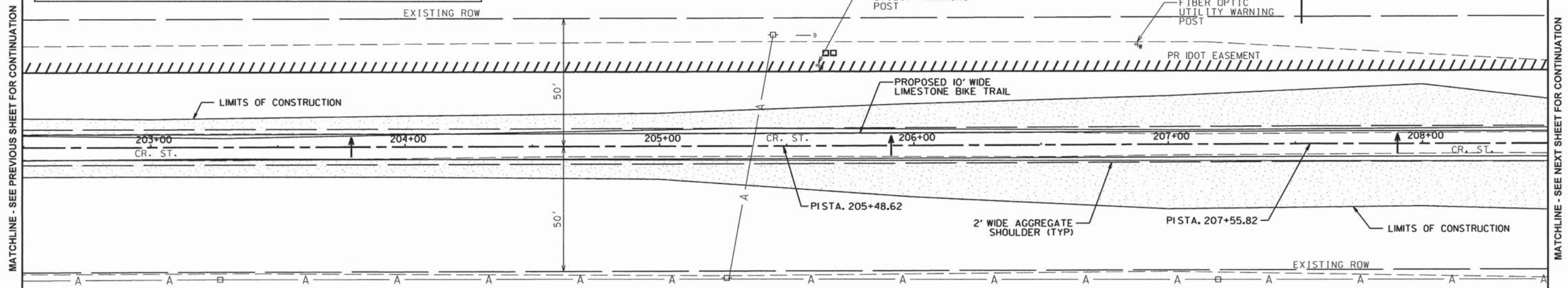



CONTRACT NO. 91520

ROUTE NO.	SECTION	COUNTY	TOTAL SHEETS	SHEET NO.
KICKAPOO TRAIL	08-F3000-02-BT	CHAMPAIGN	262	68
STA.		TO STA.		
F.H.W.A. REG.		ILLINOIS PROJECT		



**NOTE:**  
 IF ANY TREE OUTSIDE OF THE LIMITS OF CONSTRUCTION THAT ARE ADVERSELY AFFECTED DUE TO CONSTRUCTION ACTIVITIES INCLUDING, BUT NOT LIMITED TO, ROOT DISTURBANCE, BARK REMOVAL, LIMB DAMAGE, THE TREE SHALL BE REMOVED IN ITS ENTIRETY AND HAULED OFF THE SITE AND DISPOSED OFF LEGALLY AT THE CONTRACTOR'S EXPENSE.  
 THE CONTRACTOR SHALL MAKE EVERY EFFORT TO LIMIT HIS OPERATIONS WITHIN THE DESIGNATED LIMITS OF CONSTRUCTION.  
 AT THE OPTION OF THE CCFP, TREES DAMAGED AND REMOVED OUTSIDE OF THE LIMITS OF CONSTRUCTION, THE COST OF REPLACING SAID TREES SHALL BE BORNE BY THE CONTRACTOR.

2'x3' CONC. BOX CULVERT  
 IE. S. = 689.30  
 IE. N. = 689.57

FIBER OPTIC UTILITY WARNING POST

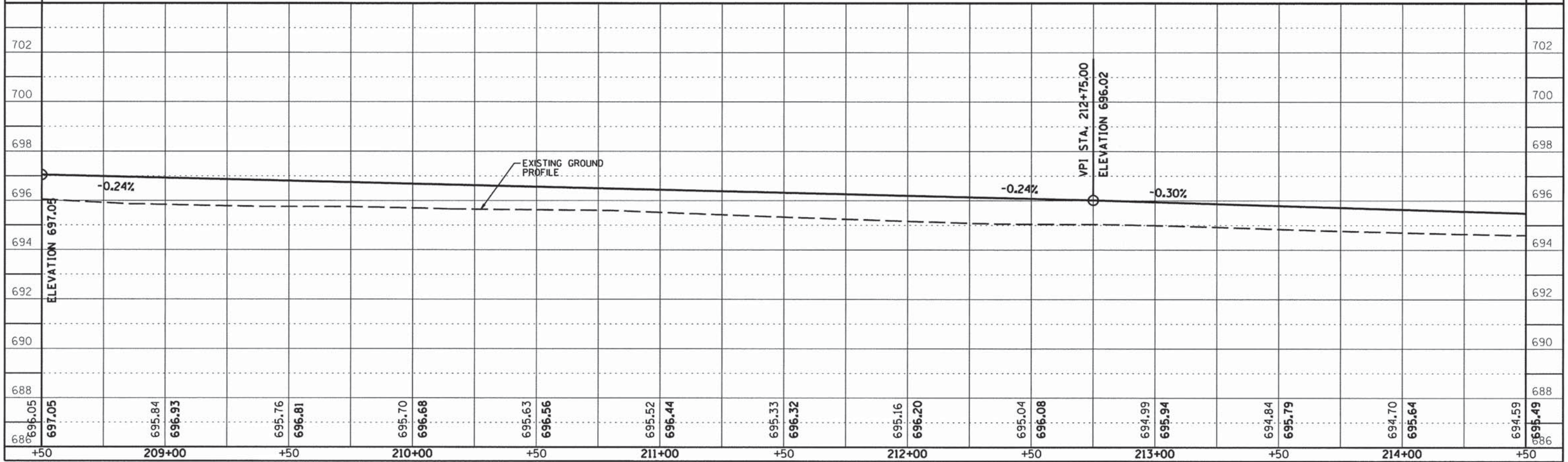
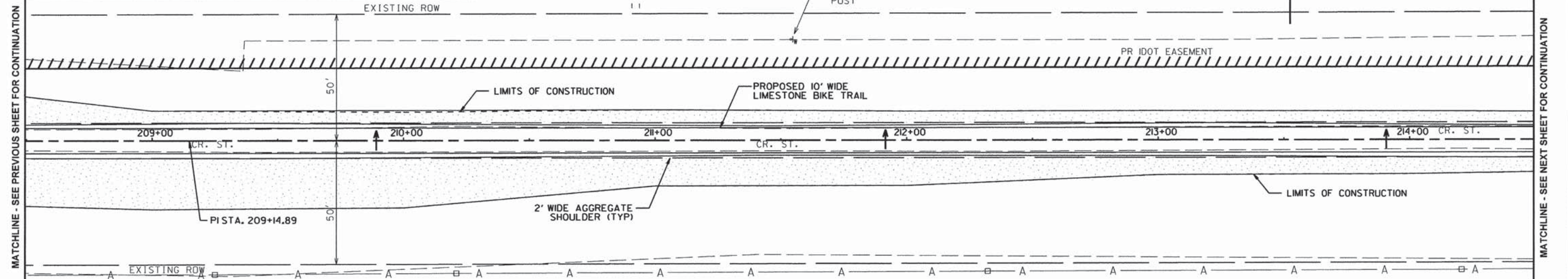

CONTRACT NO. 91520

ROUTE NO.	SECTION	COUNTY	TOTAL SHEETS	SHEET NO.
KICKAPOO TRAIL	08-F3000-02-BT	CHAMPAIGN	262	69
STA.	TO STA.			
F.H.W.A. REG.	ILLINOIS	PROJECT		

**NOTE:**  
 IF ANY TREE OUTSIDE OF THE LIMITS OF CONSTRUCTION THAT ARE ADVERSELY AFFECTED DUE TO CONSTRUCTION ACTIVITIES INCLUDING, BUT NOT LIMITED TO, ROOT DISTURBANCE, BARK REMOVAL, LIMB DAMAGE, THE TREE SHALL BE REMOVED IN ITS ENTIRETY AND HAULED OFF THE SITE AND DISPOSED OFF LEGALLY AT THE CONTRACTOR'S EXPENSE.  
 THE CONTRACTOR SHALL MAKE EVERY EFFORT TO LIMIT HIS OPERATIONS WITHIN THE DESIGNATED LIMITS OF CONSTRUCTION.  
 AT THE OPTION OF THE CCFP, TREES DAMAGED AND REMOVED OUTSIDE OF THE LIMITS OF CONSTRUCTION, THE COST OF REPLACING SAID TREES SHALL BE BORNE BY THE CONTRACTOR.

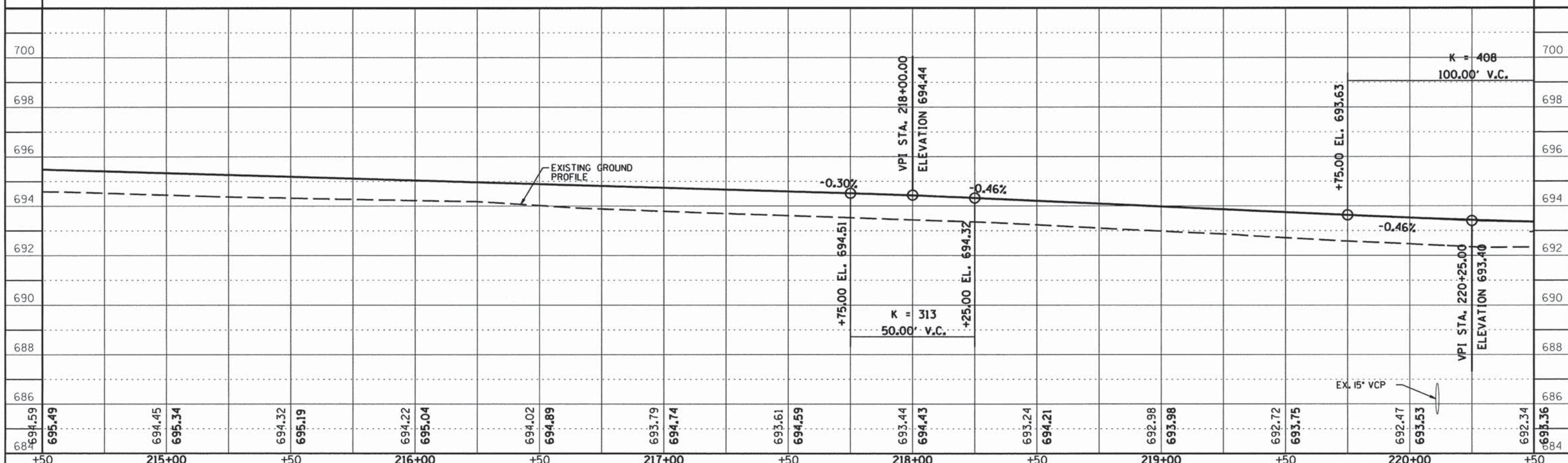
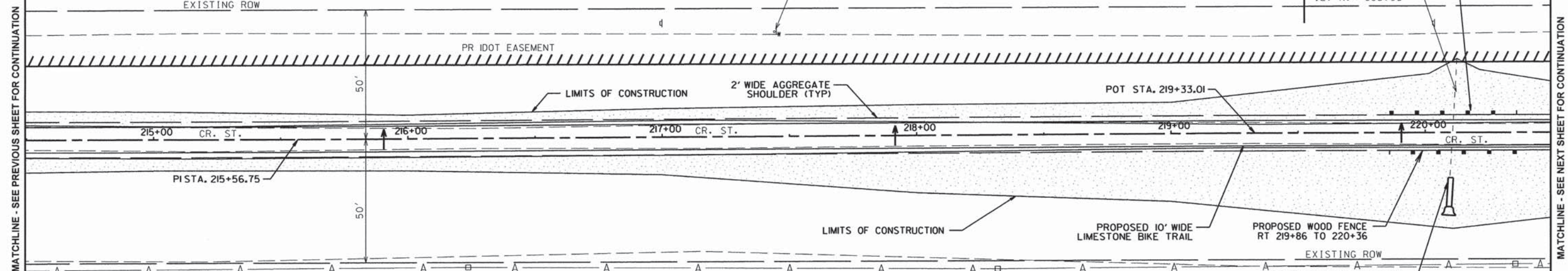
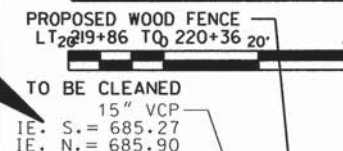

CONTRACT NO. 91520

ROUTE NO.	SECTION	COUNTY	TOTAL SHEETS	SHEET NO.
KICKAPOO TRAIL	08-F3000-02-BT	CHAMPAIGN	262	70
STA.		TO STA.		
F.H.W.A. REG.		ILLINOIS PROJECT		



**NOTE:**  
 IF ANY TREE OUTSIDE OF THE LIMITS OF CONSTRUCTION THAT ARE ADVERSELY AFFECTED DUE TO CONSTRUCTION ACTIVITIES INCLUDING, BUT NOT LIMITED TO, ROOT DISTURBANCE, BARK REMOVAL, LIMB DAMAGE, THE TREE SHALL BE REMOVED IN ITS ENTIRETY AND HAULED OFF THE SITE AND DISPOSED OFF LEGALLY AT THE CONTRACTOR'S EXPENSE.  
 THE CONTRACTOR SHALL MAKE EVERY EFFORT TO LIMIT HIS OPERATIONS WITHIN THE DESIGNATED LIMITS OF CONSTRUCTION.  
 AT THE OPTION OF THE CCFP, TREES DAMAGED AND REMOVED OUTSIDE OF THE LIMITS OF CONSTRUCTION, THE COST OF REPLACING SAID TREES SHALL BE BORNE BY THE CONTRACTOR.

1.5' x 2.0' CONC. BOX CULVERT  
 IE. S. = 686.52  
 IE. N. = 687.00

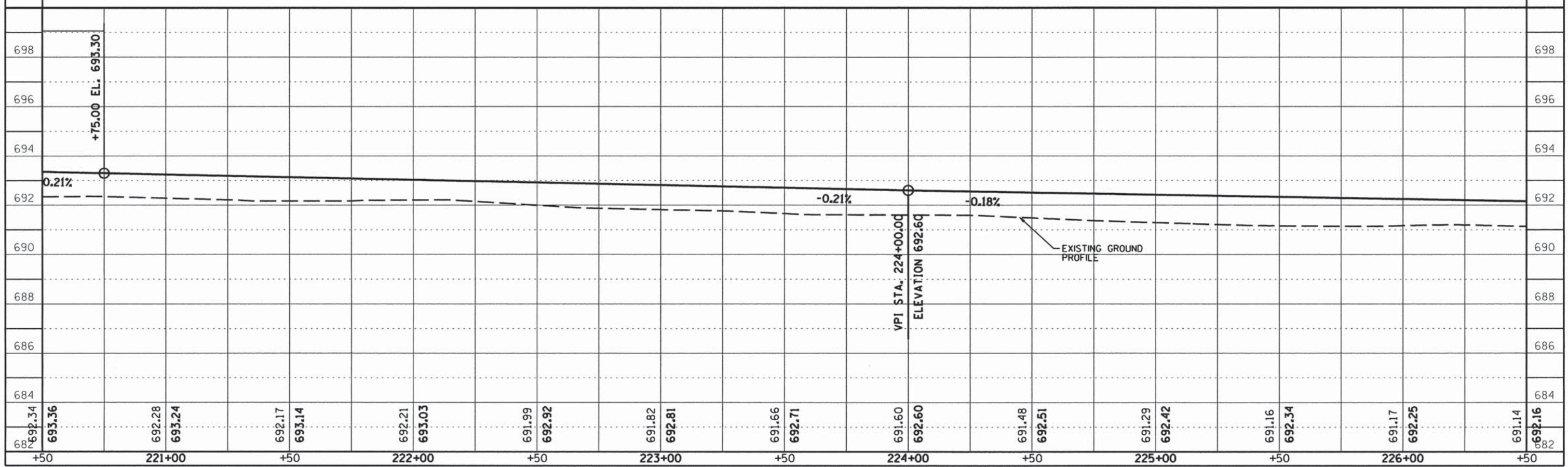
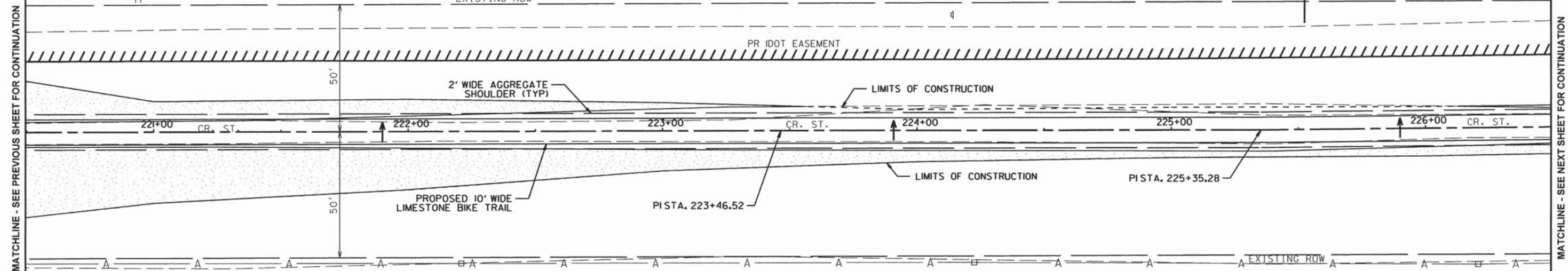

CONTRACT NO. 91520

ROUTE NO.	SECTION	COUNTY	TOTAL SHEETS	SHEET NO.
KICKAPOO TRAIL	08-F-3000-02-BT	CHAMPAIGN	262	71
STA.	TO STA.			
F.H.W.A. REG.	ILLINOIS	PROJECT		

**NOTE:**  
 IF ANY TREE OUTSIDE OF THE LIMITS OF CONSTRUCTION THAT ARE ADVERSELY AFFECTED DUE TO CONSTRUCTION ACTIVITIES INCLUDING, BUT NOT LIMITED TO, ROOT DISTURBANCE, BARK REMOVAL, LIMB DAMAGE, THE TREE SHALL BE REMOVED IN ITS ENTIRETY AND HAULED OFF THE SITE AND DISPOSED OFF LEGALLY AT THE CONTRACTOR'S EXPENSE.  
 THE CONTRACTOR SHALL MAKE EVERY EFFORT TO LIMIT HIS OPERATIONS WITHIN THE DESIGNATED LIMITS OF CONSTRUCTION.  
 AT THE OPTION OF THE CCFP, TREES DAMAGED AND REMOVED OUTSIDE OF THE LIMITS OF CONSTRUCTION, THE COST OF REPLACING SAID TREES SHALL BE BORNE BY THE CONTRACTOR.

**FG BENCHMARK 5 - ELEV. 690.97**  
 SET MAG SPIKE IN NORTHWEST FACE OF UTILITY POLE SOUTH OF CUSTOM SERVICE CRANE COMPANY.

MAYVIEW, IL

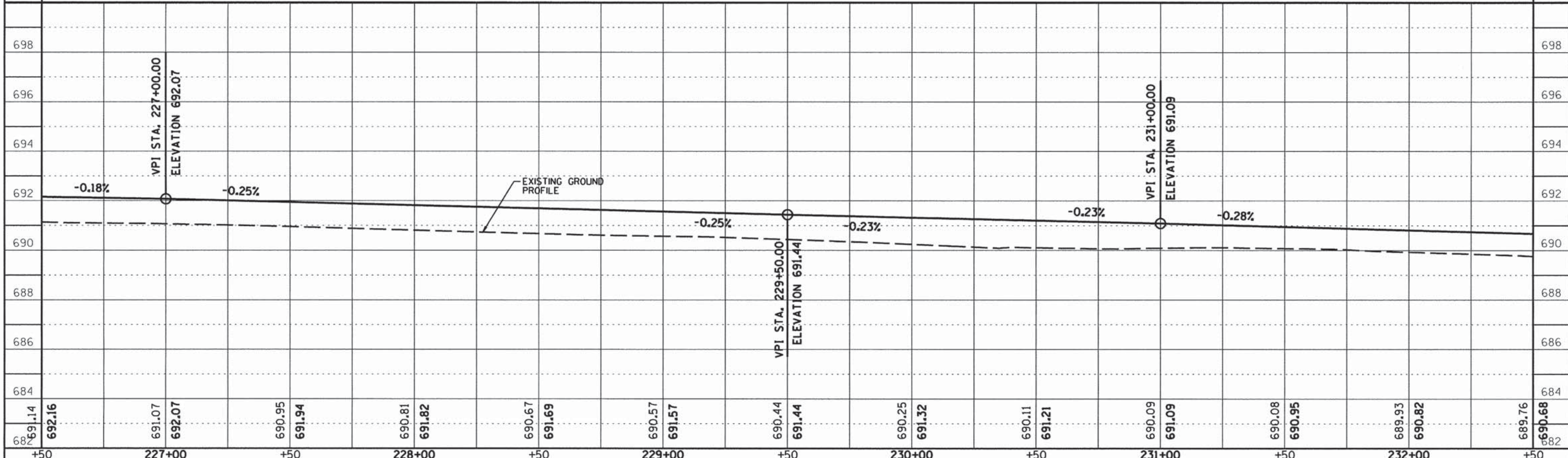
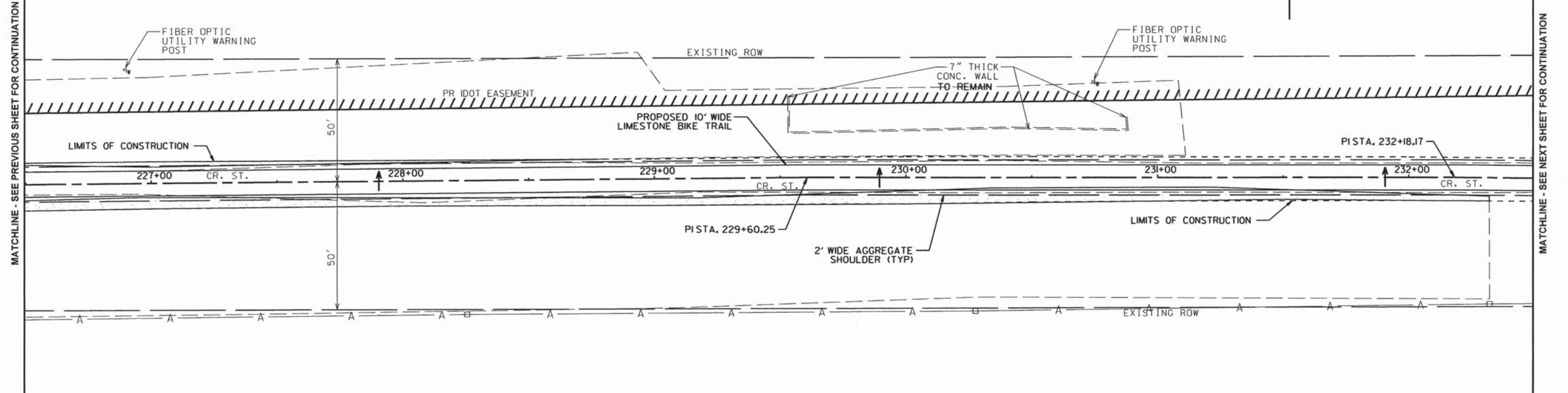

CONTRACT NO. 91520

ROUTE NO.	SECTION	COUNTY	TOTAL SHEETS	SHEET NO.
KICKAPOO TRAIL	08-F3000-02-BT	CHAMPAIGN	262	72
STA.	TO STA.			
F.H.W.A. REG.	ILLINOIS	PROJECT		

**NOTE:**  
 IF ANY TREE OUTSIDE OF THE LIMITS OF CONSTRUCTION THAT ARE ADVERSELY AFFECTED DUE TO CONSTRUCTION ACTIVITIES INCLUDING, BUT NOT LIMITED TO, ROOT DISTURBANCE, BARK REMOVAL, LIMB DAMAGE, THE TREE SHALL BE REMOVED IN ITS ENTIRETY AND HAULED OFF THE SITE AND DISPOSED OFF LEGALLY AT THE CONTRACTOR'S EXPENSE.  
 THE CONTRACTOR SHALL MAKE EVERY EFFORT TO LIMIT HIS OPERATIONS WITHIN THE DESIGNATED LIMITS OF CONSTRUCTION.  
 AT THE OPTION OF THE CCFP, TREES DAMAGED AND REMOVED OUTSIDE OF THE LIMITS OF CONSTRUCTION, THE COST OF REPLACING SAID TREES SHALL BE BORNE BY THE CONTRACTOR.

MAYVIEW, IL

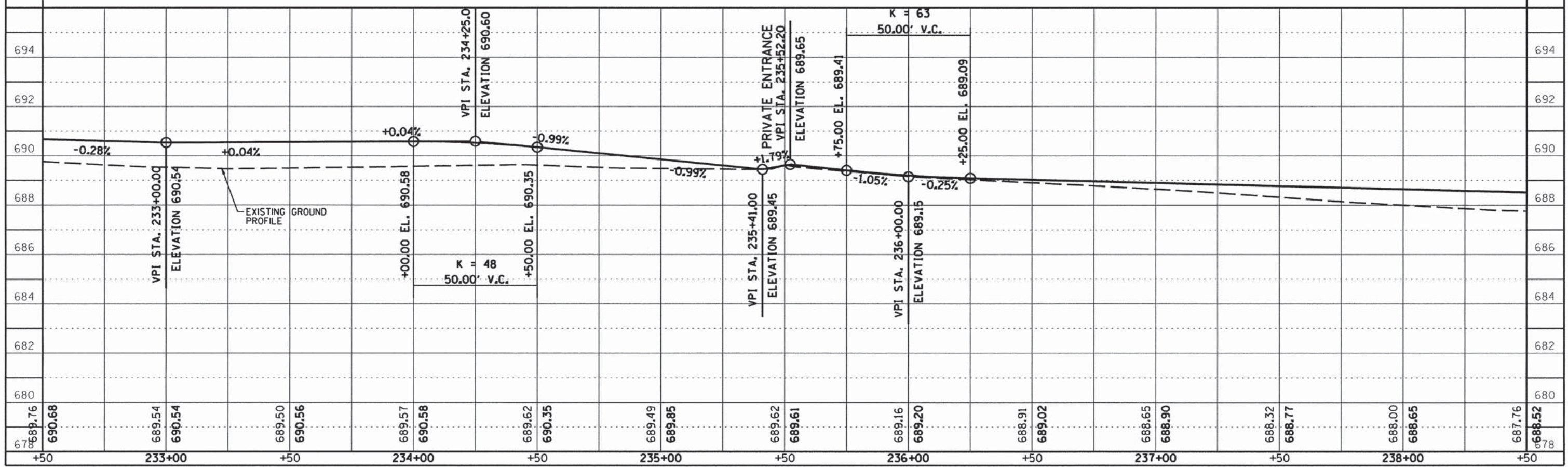
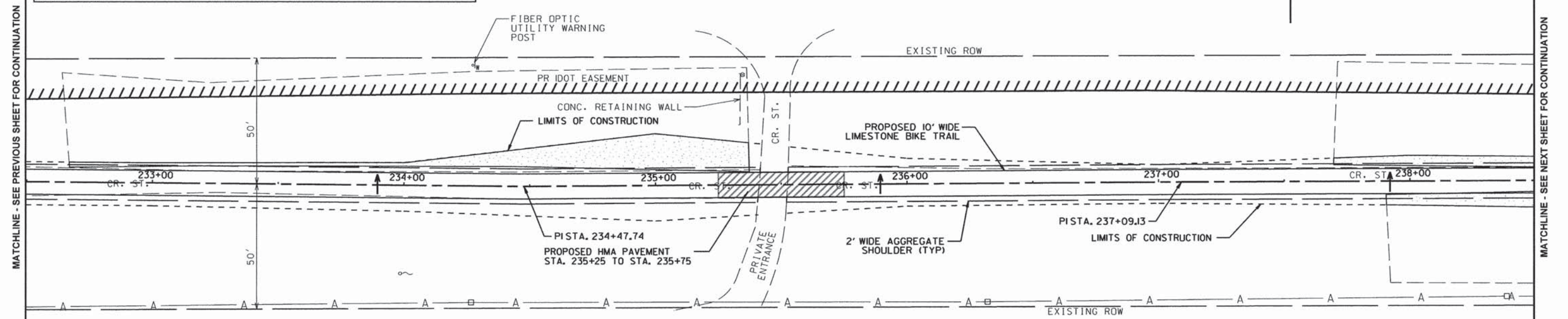

CONTRACT NO. 91520

ROUTE NO.	SECTION	COUNTY	TOTAL SHEETS	SHEET NO.
KICKAPOO TRAIL	08-F3000-02-BT	CHAMPAIGN	262	73
STA.	TO STA.			
F.H.W.A. REG.	ILLINOIS PROJECT			

**NOTE:**  
 IF ANY TREE OUTSIDE OF THE LIMITS OF CONSTRUCTION THAT ARE ADVERSELY AFFECTED DUE TO CONSTRUCTION ACTIVITIES INCLUDING, BUT NOT LIMITED TO, ROOT DISTURBANCE, BARK REMOVAL, LIMB DAMAGE, THE TREE SHALL BE REMOVED IN ITS ENTIRETY AND HAULED OFF THE SITE AND DISPOSED OFF LEGALLY AT THE CONTRACTOR'S EXPENSE.  
 THE CONTRACTOR SHALL MAKE EVERY EFFORT TO LIMIT HIS OPERATIONS WITHIN THE DESIGNATED LIMITS OF CONSTRUCTION.  
 AT THE OPTION OF THE CCFP, TREES DAMAGED AND REMOVED OUTSIDE OF THE LIMITS OF CONSTRUCTION, THE COST OF REPLACING SAID TREES SHALL BE BORNE BY THE CONTRACTOR.

MAYVIEW, IL



MATCHLINE - SEE PREVIOUS SHEET FOR CONTINUATION

MATCHLINE - SEE NEXT SHEET FOR CONTINUATION

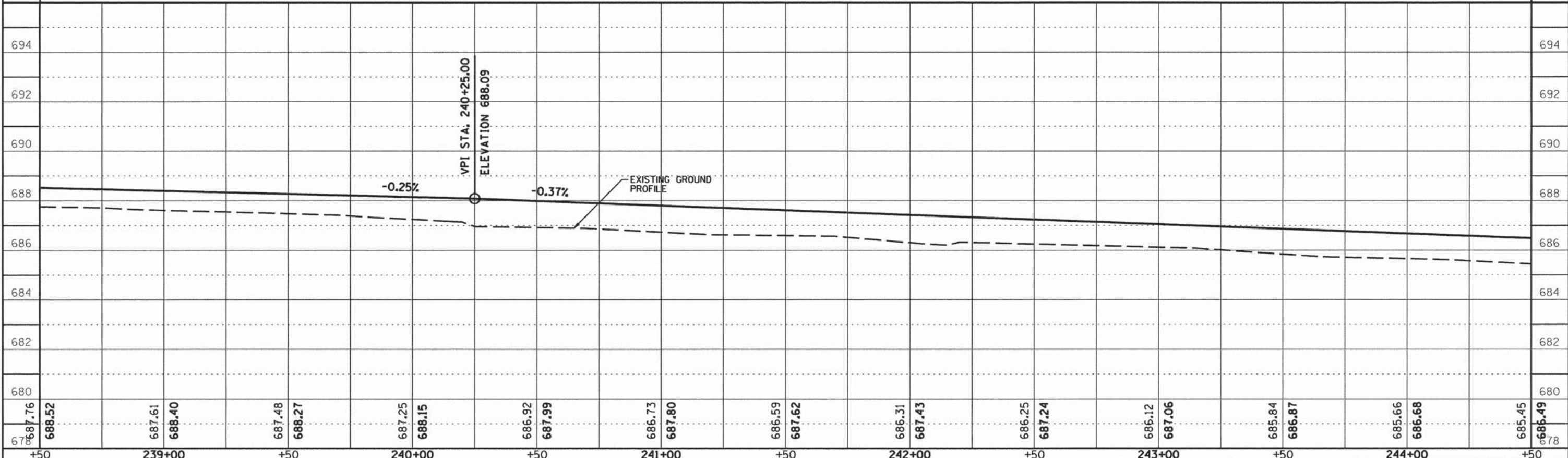
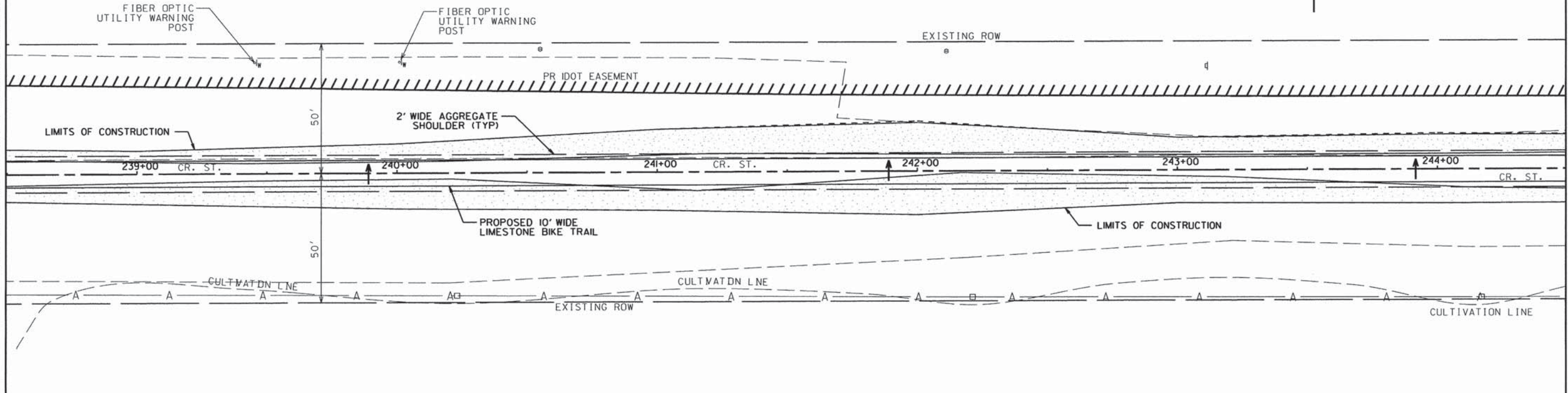

CONTRACT NO. 91520

ROUTE NO.	SECTION	COUNTY	TOTAL SHEETS	SHEET NO.
KICKAPOO TRAIL	08-F3000-02-BT	CHAMPAIGN	262	74
STA.	TO STA.			
F.H.W.A. REG.	ILLINOIS	PROJECT		

**NOTE:**  
 IF ANY TREE OUTSIDE OF THE LIMITS OF CONSTRUCTION THAT ARE ADVERSELY AFFECTED DUE TO CONSTRUCTION ACTIVITIES INCLUDING, BUT NOT LIMITED TO, ROOT DISTURBANCE, BARK REMOVAL, LIMB DAMAGE, THE TREE SHALL BE REMOVED IN ITS ENTIRETY AND HAULED OFF THE SITE AND DISPOSED OFF LEGALLY AT THE CONTRACTOR'S EXPENSE.  
 THE CONTRACTOR SHALL MAKE EVERY EFFORT TO LIMIT HIS OPERATIONS WITHIN THE DESIGNATED LIMITS OF CONSTRUCTION.  
 AT THE OPTION OF THE CCFP, TREES DAMAGED AND REMOVED OUTSIDE OF THE LIMITS OF CONSTRUCTION, THE COST OF REPLACING SAID TREES SHALL BE BORNE BY THE CONTRACTOR.

MAYVIEW, IL

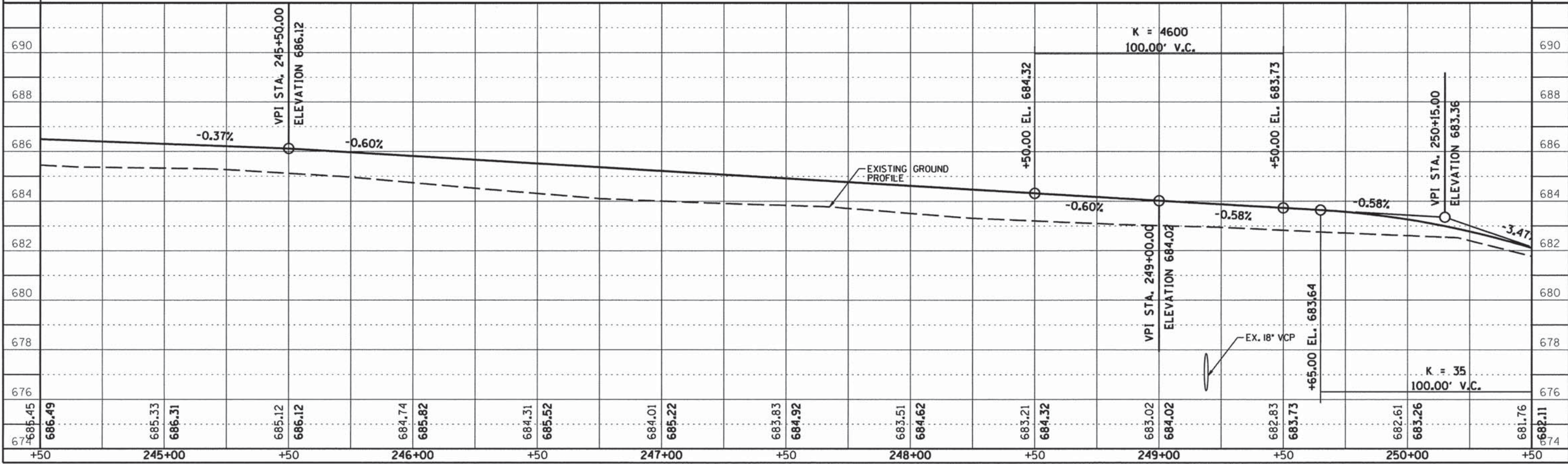
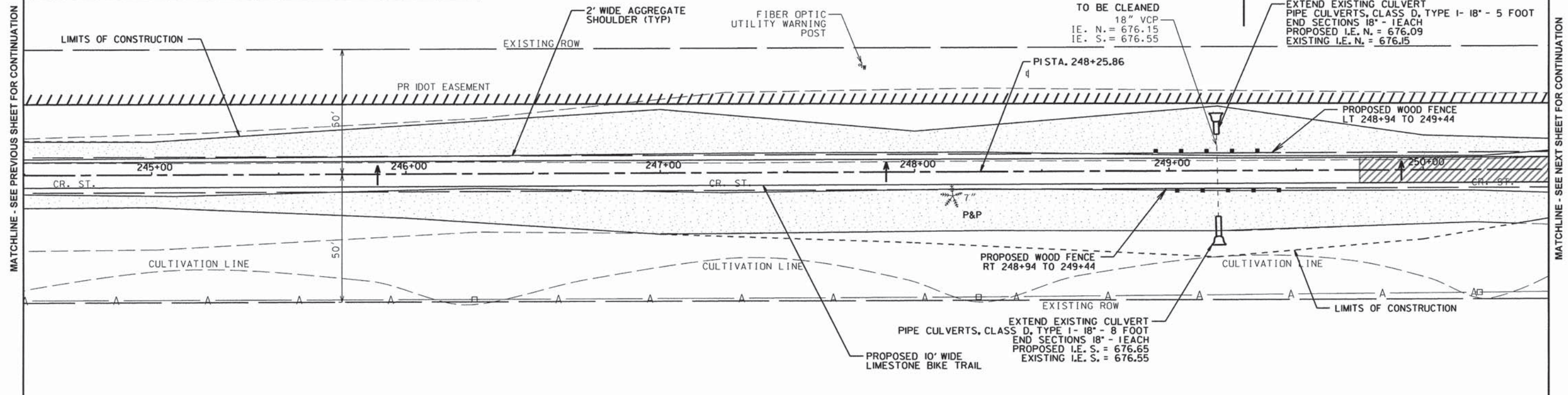

CONTRACT NO. 91520

ROUTE NO.	SECTION	COUNTY	TOTAL SHEETS	SHEET NO.
KICKAPOO TRAIL	08-F3000-02-BT	CHAMPAIGN	262	75
STA. TO STA.		F.H.W.A. REG. ILLINOIS PROJECT		



MAYVIEW, IL

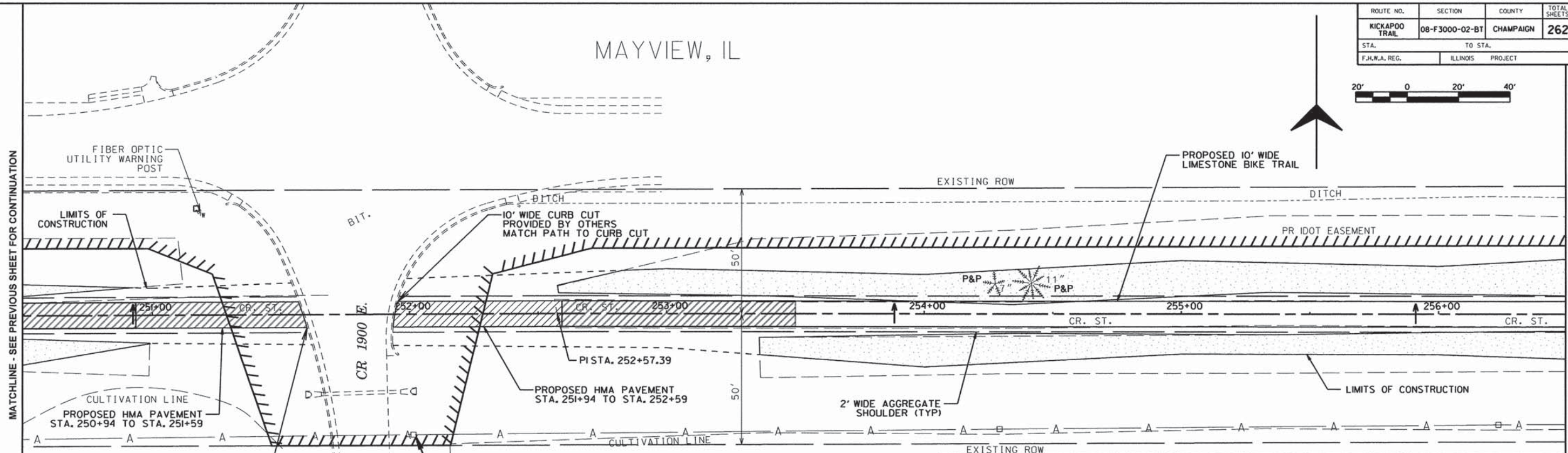

MATCHLINE - SEE PREVIOUS SHEET FOR CONTINUATION

MATCHLINE - SEE NEXT SHEET FOR CONTINUATION

**NOTE:**  
 IF ANY TREE OUTSIDE OF THE LIMITS OF CONSTRUCTION THAT ARE ADVERSELY AFFECTED DUE TO CONSTRUCTION ACTIVITIES INCLUDING, BUT NOT LIMITED TO, ROOT DISTURBANCE, BARK REMOVAL, LIMB DAMAGE, THE TREE SHALL BE REMOVED IN ITS ENTIRETY AND HAULED OFF THE SITE AND DISPOSED OFF LEGALLY AT THE CONTRACTOR'S EXPENSE.  
 THE CONTRACTOR SHALL MAKE EVERY EFFORT TO LIMIT HIS OPERATIONS WITHIN THE DESIGNATED LIMITS OF CONSTRUCTION.  
 AT THE OPTION OF THE CCFP, TREES DAMAGED AND REMOVED OUTSIDE OF THE LIMITS OF CONSTRUCTION, THE COST OF REPLACING SAID TREES SHALL BE BORNE BY THE CONTRACTOR.

**FG BENCHMARK 6 - ELEV. 678.86**  
 SET MAG SPIKE IN NORTH FACE OF UTILITY POLE, 3RD POLE SOUTH OF US 150, EAST OF 1900E.

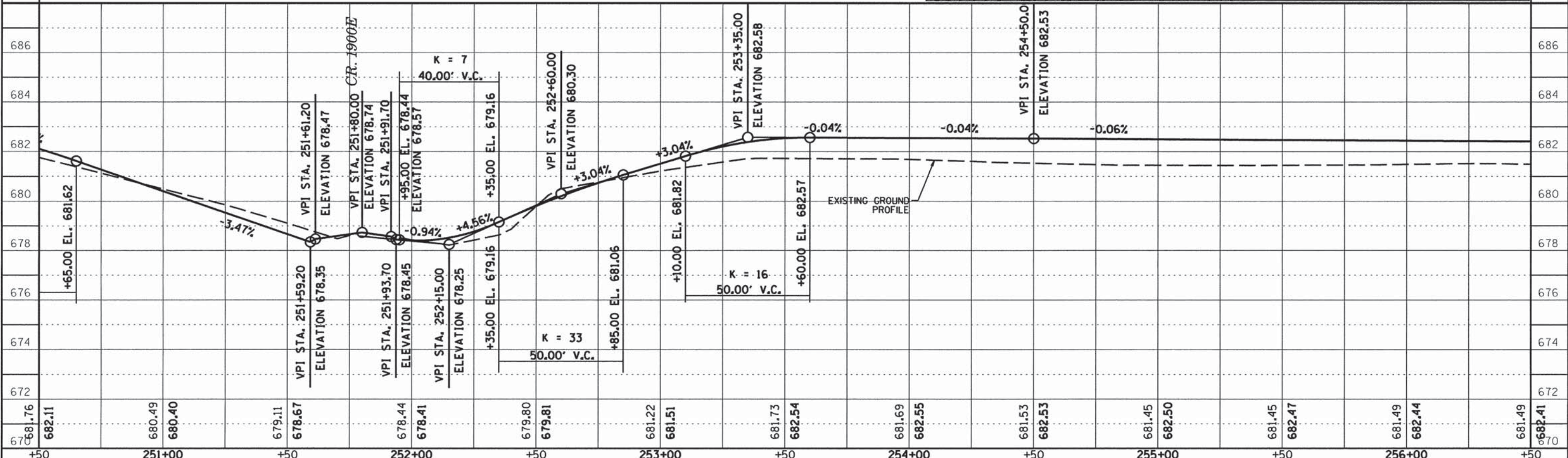



CONTRACT NO. 91520

ROUTE NO.	SECTION	COUNTY	TOTAL SHEETS	SHEET NO.
KICKAPOO TRAIL	08-F3000-02-BT	CHAMPAIGN	262	76
STA.		TO STA.		
F.H.W.A. REG.		ILLINOIS PROJECT		



**NOTE:**  
 IF ANY TREE OUTSIDE OF THE LIMITS OF CONSTRUCTION THAT ARE ADVERSELY AFFECTED DUE TO CONSTRUCTION ACTIVITIES INCLUDING, BUT NOT LIMITED TO, ROOT DISTURBANCE, BARK REMOVAL, LIMB DAMAGE, THE TREE SHALL BE REMOVED IN ITS ENTIRETY AND HAULED OFF THE SITE AND DISPOSED OFF LEGALLY AT THE CONTRACTOR'S EXPENSE.  
 THE CONTRACTOR SHALL MAKE EVERY EFFORT TO LIMIT HIS OPERATIONS WITHIN THE DESIGNATED LIMITS OF CONSTRUCTION.  
 AT THE OPTION OF THE CCFP, TREES DAMAGED AND REMOVED OUTSIDE OF THE LIMITS OF CONSTRUCTION, THE COST OF REPLACING SAID TREES SHALL BE BORNE BY THE CONTRACTOR.

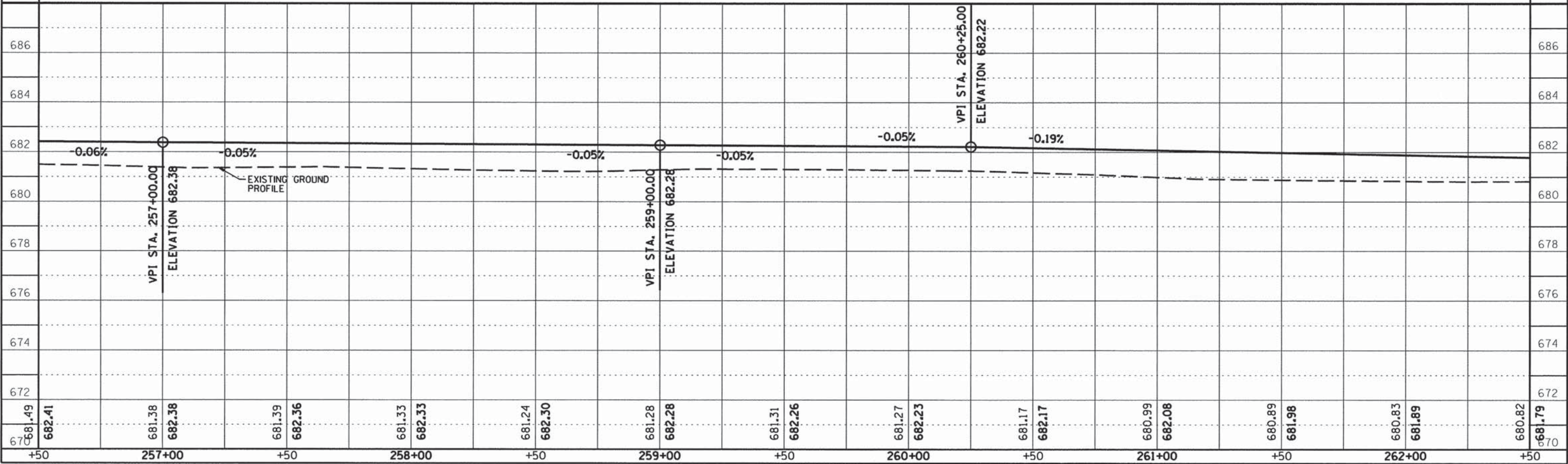
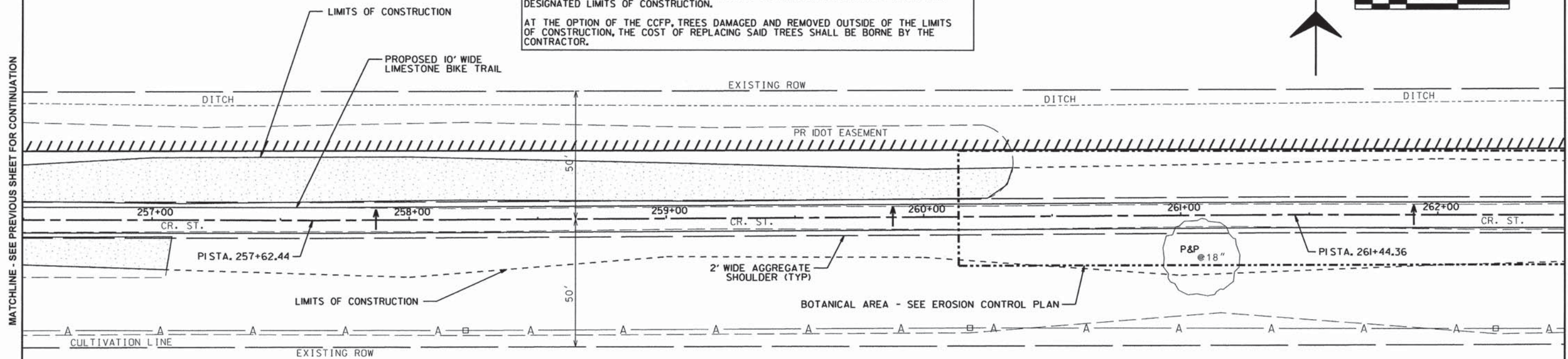

CONTRACT NO. 91520

ROUTE NO.	SECTION	COUNTY	TOTAL SHEETS	SHEET NO.
KICKAPOO TRAIL	08-F3000-02-BT	CHAMPAIGN	262	77
STA. TO STA.		ILLINOIS PROJECT		
F.H.W.A. REG.		PROJECT		



**NOTE:**  
 IF ANY TREE OUTSIDE OF THE LIMITS OF CONSTRUCTION THAT ARE ADVERSELY AFFECTED DUE TO CONSTRUCTION ACTIVITIES INCLUDING, BUT NOT LIMITED TO, ROOT DISTURBANCE, BARK REMOVAL, LIMB DAMAGE, THE TREE SHALL BE REMOVED IN ITS ENTIRETY AND HAULED OFF THE SITE AND DISPOSED OFF LEGALLY AT THE CONTRACTOR'S EXPENSE.  
 THE CONTRACTOR SHALL MAKE EVERY EFFORT TO LIMIT HIS OPERATIONS WITHIN THE DESIGNATED LIMITS OF CONSTRUCTION.  
 AT THE OPTION OF THE CCFP, TREES DAMAGED AND REMOVED OUTSIDE OF THE LIMITS OF CONSTRUCTION, THE COST OF REPLACING SAID TREES SHALL BE BORNE BY THE CONTRACTOR.

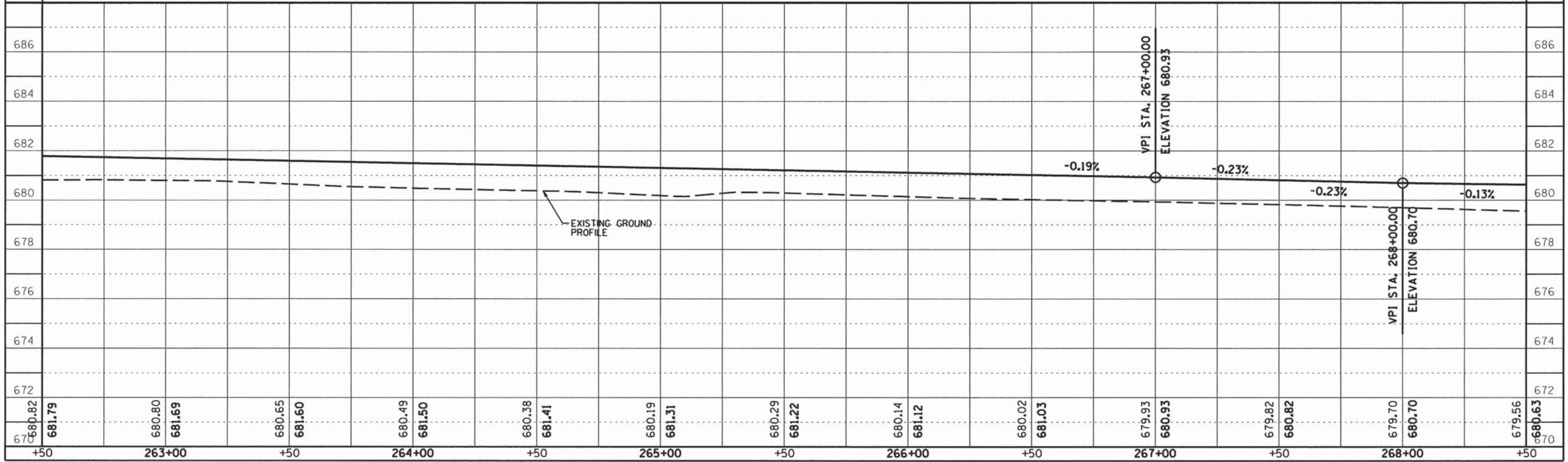
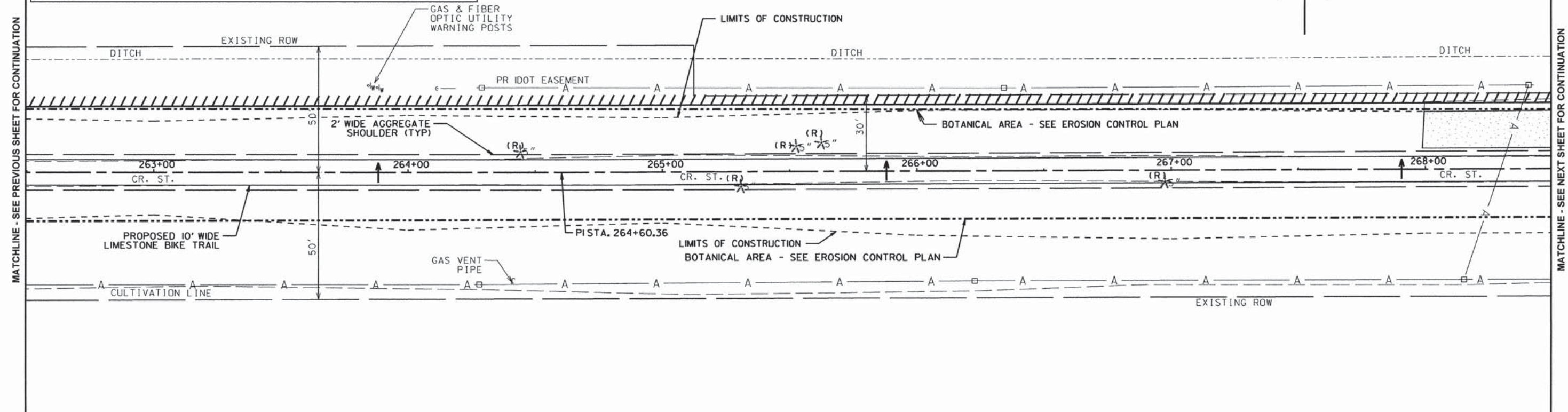

CONTRACT NO. 91520

ROUTE NO.	SECTION	COUNTY	TOTAL SHEETS	SHEET NO.
KICKAPOO TRAIL	08-F3000-02-BT	CHAMPAIGN	262	78
STA.	TO STA.			
F.H.W.A. REG.	ILLINOIS	PROJECT		



**NOTE:**  
 IF ANY TREE OUTSIDE OF THE LIMITS OF CONSTRUCTION THAT ARE ADVERSELY AFFECTED DUE TO CONSTRUCTION ACTIVITIES INCLUDING, BUT NOT LIMITED TO, ROOT DISTURBANCE, BARK REMOVAL, LIMB DAMAGE, THE TREE SHALL BE REMOVED IN ITS ENTIRETY AND HAULED OFF THE SITE AND DISPOSED OFF LEGALLY AT THE CONTRACTOR'S EXPENSE.  
 THE CONTRACTOR SHALL MAKE EVERY EFFORT TO LIMIT HIS OPERATIONS WITHIN THE DESIGNATED LIMITS OF CONSTRUCTION.  
 AT THE OPTION OF THE CCFP, TREES DAMAGED AND REMOVED OUTSIDE OF THE LIMITS OF CONSTRUCTION, THE COST OF REPLACING SAID TREES SHALL BE BORNE BY THE CONTRACTOR.

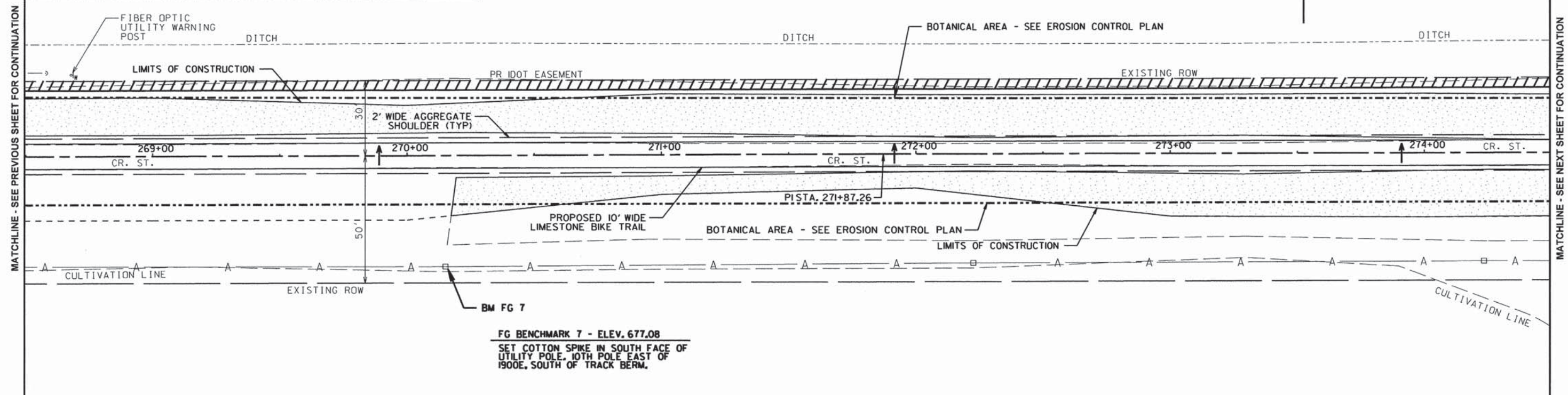

**FG BENCHMARK 7 - ELEV. 677.08**  
 SET COTTON SPIKE IN SOUTH FACE OF UTILITY POLE, 10TH POLE EAST OF 1900E, SOUTH OF TRACK BERM.

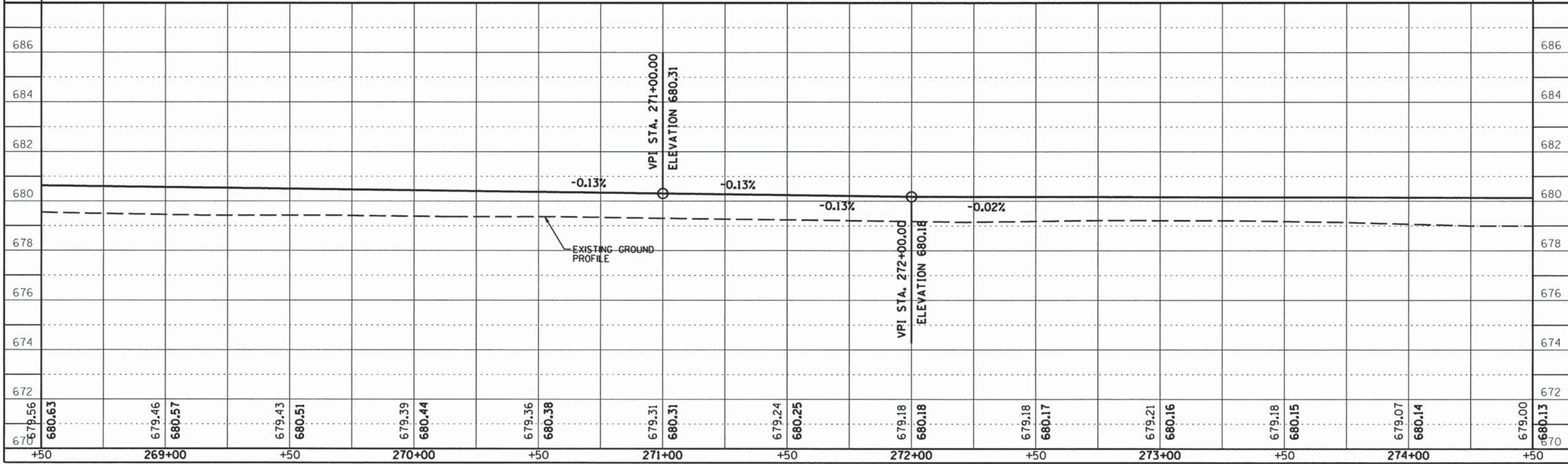

CONTRACT NO. 91520

ROUTE NO.	SECTION	COUNTY	TOTAL SHEETS	SHEET NO.
KICKAPOO TRAIL	08-F3000-02-BT	CHAMPAIGN	262	79
STA.	TO STA.			
F.H.W.A. REG.	ILLINOIS	PROJECT		



**NOTE:**  
 IF ANY TREE OUTSIDE OF THE LIMITS OF CONSTRUCTION THAT ARE ADVERSELY AFFECTED DUE TO CONSTRUCTION ACTIVITIES INCLUDING, BUT NOT LIMITED TO, ROOT DISTURBANCE, BARK REMOVAL, LIMB DAMAGE, THE TREE SHALL BE REMOVED IN ITS ENTIRETY AND HAULED OFF THE SITE AND DISPOSED OFF LEGALLY AT THE CONTRACTOR'S EXPENSE.  
 THE CONTRACTOR SHALL MAKE EVERY EFFORT TO LIMIT HIS OPERATIONS WITHIN THE DESIGNATED LIMITS OF CONSTRUCTION.  
 AT THE OPTION OF THE CCFP, TREES DAMAGED AND REMOVED OUTSIDE OF THE LIMITS OF CONSTRUCTION, THE COST OF REPLACING SAID TREES SHALL BE BORNE BY THE CONTRACTOR.

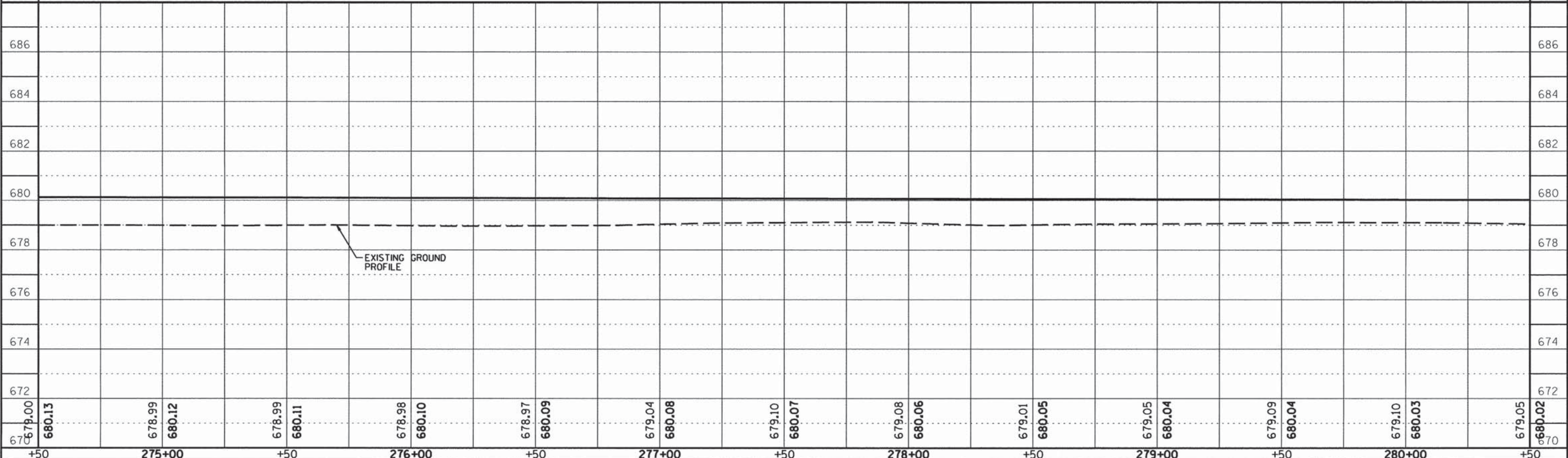
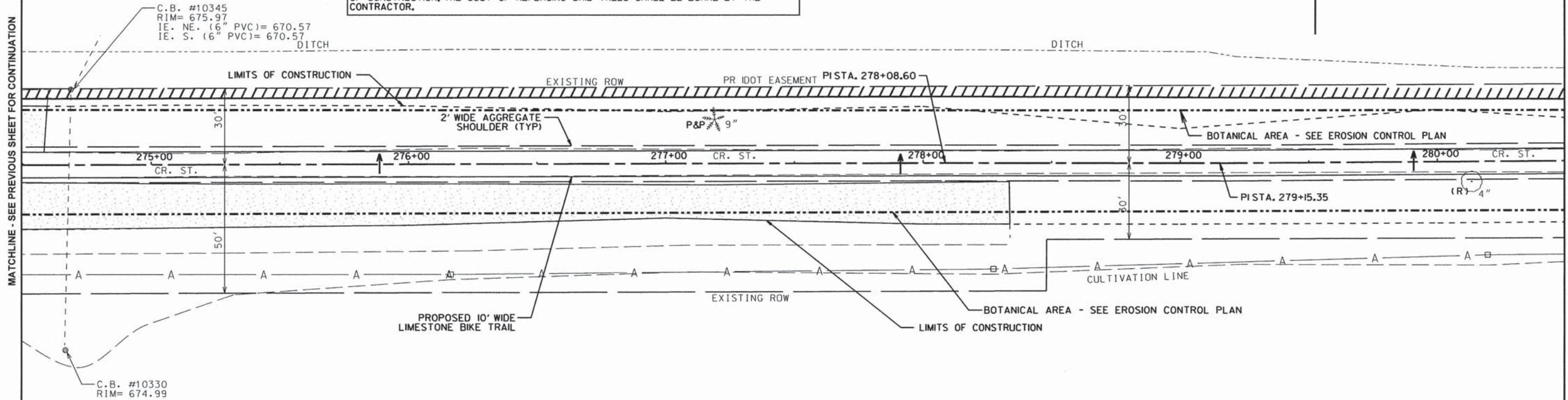

CHAMPAIGN COUNTY      KICKAPOO TRAIL - URBANA TO ST. JOSEPH      SECTION 08-F3000-02-BT      SHEET 79 OF 262 SHEETS      13-620A



CONTRACT NO. 91520

ROUTE NO.	SECTION	COUNTY	TOTAL SHEETS	SHEET NO.
KICKAPOO TRAIL	08-F3000-02-BT	CHAMPAIGN	262	81
STA.	TO STA.			
F.H.W.A. REG.	ILLINOIS PROJECT			



**NOTE:**  
 IF ANY TREE OUTSIDE OF THE LIMITS OF CONSTRUCTION THAT ARE ADVERSELY AFFECTED DUE TO CONSTRUCTION ACTIVITIES INCLUDING, BUT NOT LIMITED TO, ROOT DISTURBANCE, BARK REMOVAL, LIMB DAMAGE, THE TREE SHALL BE REMOVED IN ITS ENTIRETY AND HAULED OFF THE SITE AND DISPOSED OFF LEGALLY AT THE CONTRACTOR'S EXPENSE.  
 THE CONTRACTOR SHALL MAKE EVERY EFFORT TO LIMIT HIS OPERATIONS WITHIN THE DESIGNATED LIMITS OF CONSTRUCTION.  
 AT THE OPTION OF THE CCFP, TREES DAMAGED AND REMOVED OUTSIDE OF THE LIMITS OF CONSTRUCTION, THE COST OF REPLACING SAID TREES SHALL BE BORNE BY THE CONTRACTOR.

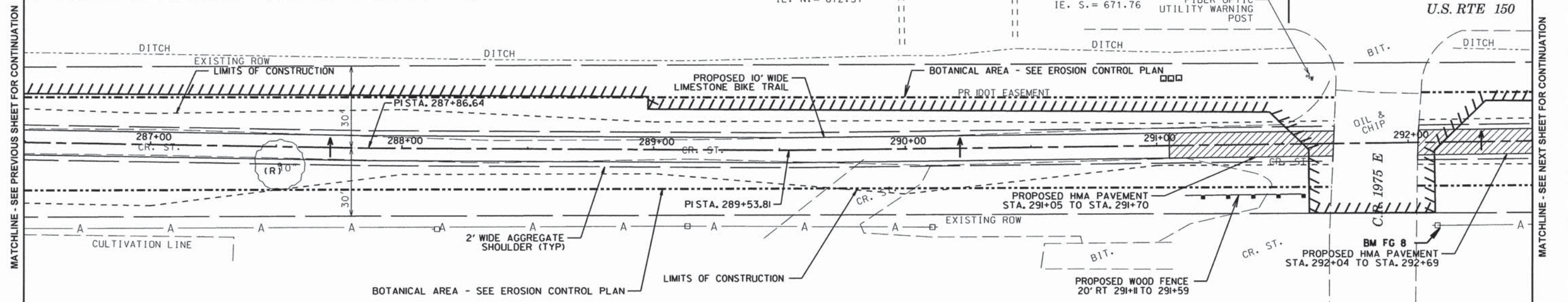

FULLS SIDING

**FG BENCHMARK 8 - ELEV. 679.78**  
 SET COTTON SPIKE IN NORTH FACE OF UTILITY POLE, FIRST POLE SOUTH OF ROUTE 150, EAST OF 1975E.

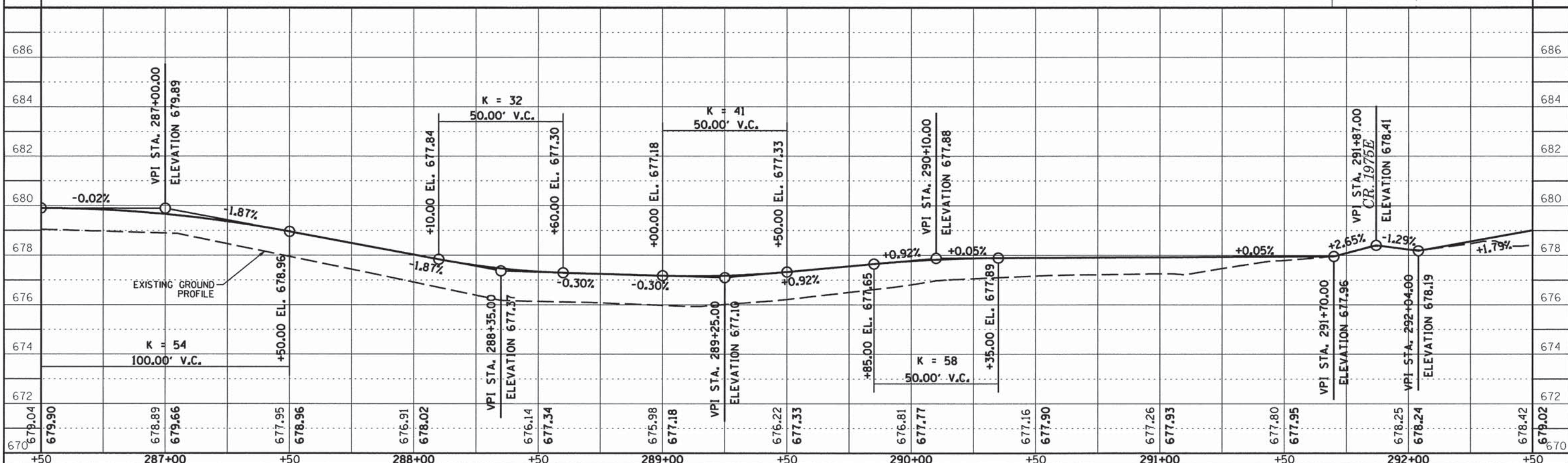

CONTRACT NO. 91520

ROUTE NO.	SECTION	COUNTY	TOTAL SHEETS	SHEET NO.
KICKAPOO TRAIL	08-F3000-02-BT	CHAMPAIGN	262	82
STA.	TO STA.			
F.H.W.A. REG.	ILLINOIS	PROJECT		

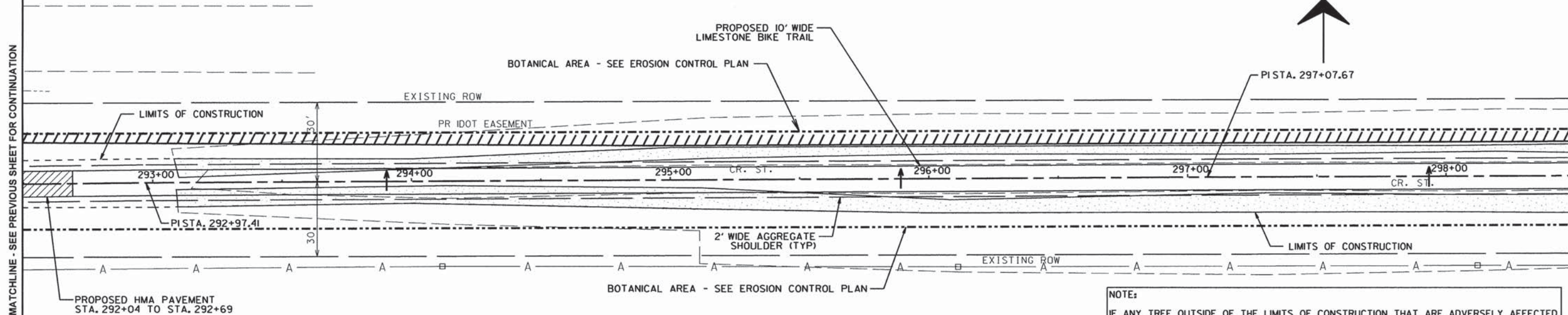

**NOTE:**  
 IF ANY TREE OUTSIDE OF THE LIMITS OF CONSTRUCTION THAT ARE ADVERSELY AFFECTED DUE TO CONSTRUCTION ACTIVITIES INCLUDING, BUT NOT LIMITED TO, ROOT DISTURBANCE, BARK REMOVAL, LIMB DAMAGE, THE TREE SHALL BE REMOVED IN ITS ENTIRETY AND HAULED OFF THE SITE AND DISPOSED OFF LEGALLY AT THE CONTRACTOR'S EXPENSE.  
 THE CONTRACTOR SHALL MAKE EVERY EFFORT TO LIMIT HIS OPERATIONS WITHIN THE DESIGNATED LIMITS OF CONSTRUCTION.  
 AT THE OPTION OF THE CCFP, TREES DAMAGED AND REMOVED OUTSIDE OF THE LIMITS OF CONSTRUCTION, THE COST OF REPLACING SAID TREES SHALL BE BORNE BY THE CONTRACTOR.

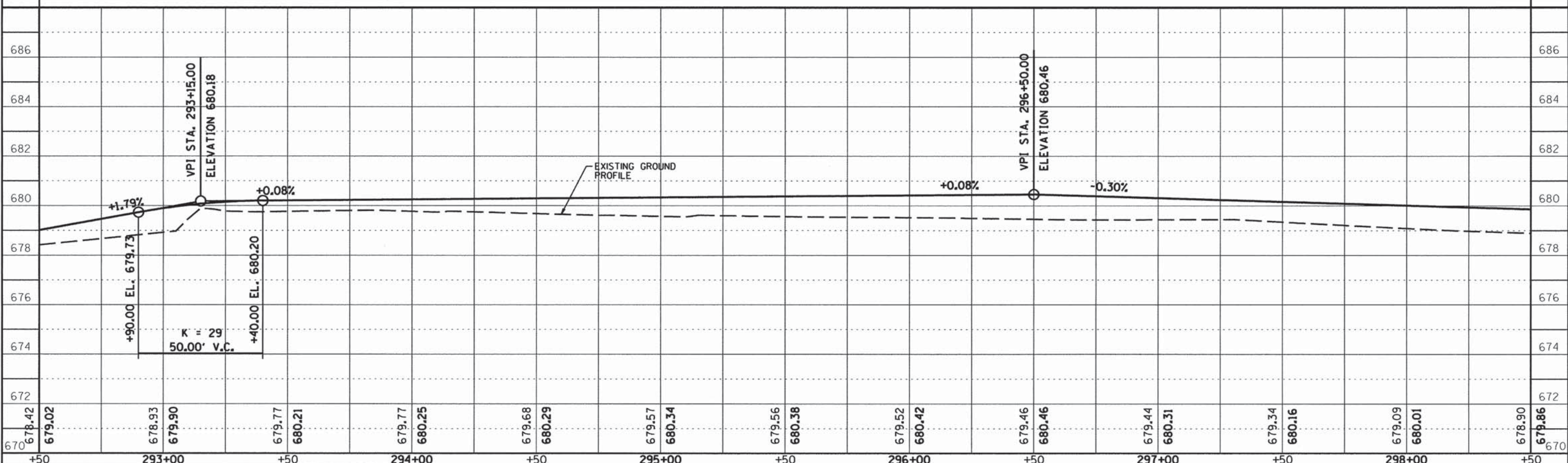

CONTRACT NO. 91520

ROUTE NO.	SECTION	COUNTY	TOTAL SHEETS	SHEET NO.
KICKAPOO TRAIL	08-F3000-02-BT	CHAMPAIGN	262	83
STA.	TO STA.			
F.I.W.A. REG.	ILLINOIS	PROJECT		

**NOTE:**  
 IF ANY TREE OUTSIDE OF THE LIMITS OF CONSTRUCTION THAT ARE ADVERSELY AFFECTED DUE TO CONSTRUCTION ACTIVITIES INCLUDING, BUT NOT LIMITED TO, ROOT DISTURBANCE, BARK REMOVAL, LIMB DAMAGE, THE TREE SHALL BE REMOVED IN ITS ENTIRETY AND HAULED OFF THE SITE AND DISPOSED OFF LEGALLY AT THE CONTRACTOR'S EXPENSE.  
 THE CONTRACTOR SHALL MAKE EVERY EFFORT TO LIMIT HIS OPERATIONS WITHIN THE DESIGNATED LIMITS OF CONSTRUCTION.  
 AT THE OPTION OF THE CCFP, TREES DAMAGED AND REMOVED OUTSIDE OF THE LIMITS OF CONSTRUCTION, THE COST OF REPLACING SAID TREES SHALL BE BORNE BY THE CONTRACTOR.



MATCHLINE - SEE PREVIOUS SHEET FOR CONTINUATION

MATCHLINE - SEE NEXT SHEET FOR CONTINUATION

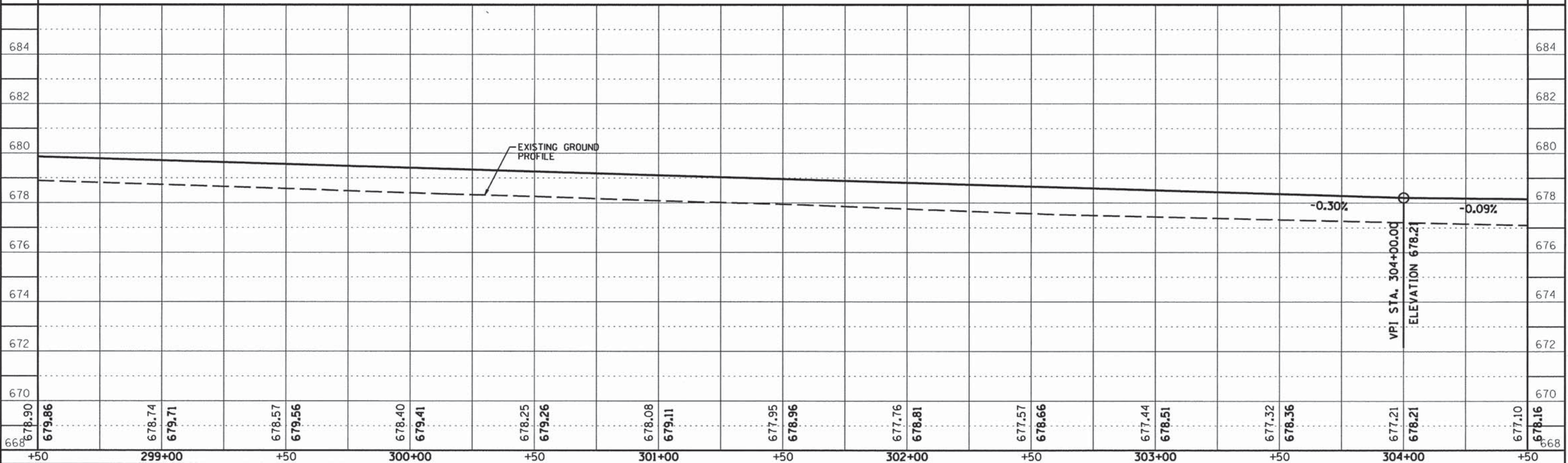
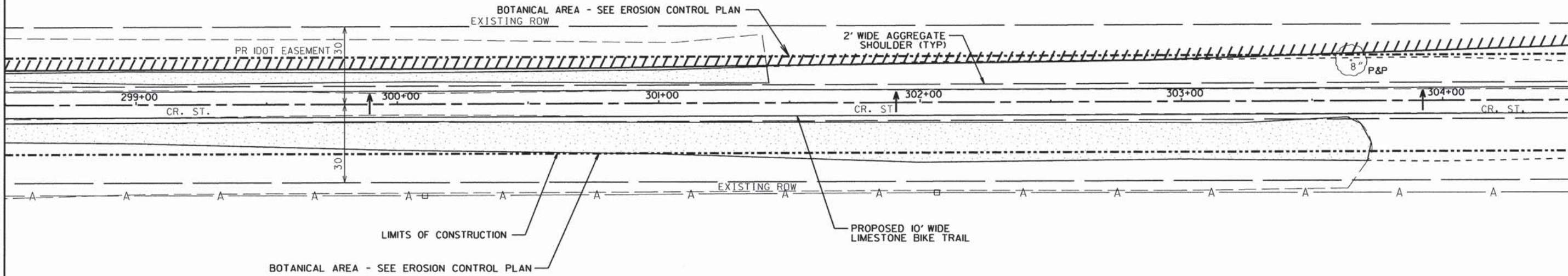



CONTRACT NO. 91520

ROUTE NO.	SECTION	COUNTY	TOTAL SHEETS	SHEET NO.
KICKAPOO TRAIL	08-F3000-02-BT	CHAMPAIGN	262	84
STA.	TO STA.			
F.H.W.A. REG.	ILLINOIS PROJECT			

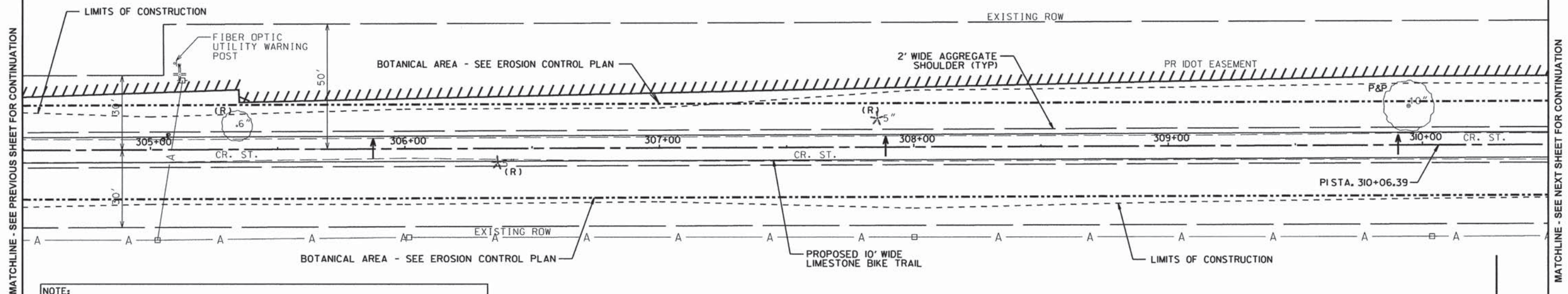

**NOTE:**  
 IF ANY TREE OUTSIDE OF THE LIMITS OF CONSTRUCTION THAT ARE ADVERSELY AFFECTED DUE TO CONSTRUCTION ACTIVITIES INCLUDING, BUT NOT LIMITED TO, ROOT DISTURBANCE, BARK REMOVAL, LIMB DAMAGE, THE TREE SHALL BE REMOVED IN ITS ENTIRETY AND HAULED OFF THE SITE AND DISPOSED OFF LEGALLY AT THE CONTRACTOR'S EXPENSE.  
 THE CONTRACTOR SHALL MAKE EVERY EFFORT TO LIMIT HIS OPERATIONS WITHIN THE DESIGNATED LIMITS OF CONSTRUCTION.  
 AT THE OPTION OF THE CCFP, TREES DAMAGED AND REMOVED OUTSIDE OF THE LIMITS OF CONSTRUCTION, THE COST OF REPLACING SAID TREES SHALL BE BORNE BY THE CONTRACTOR.

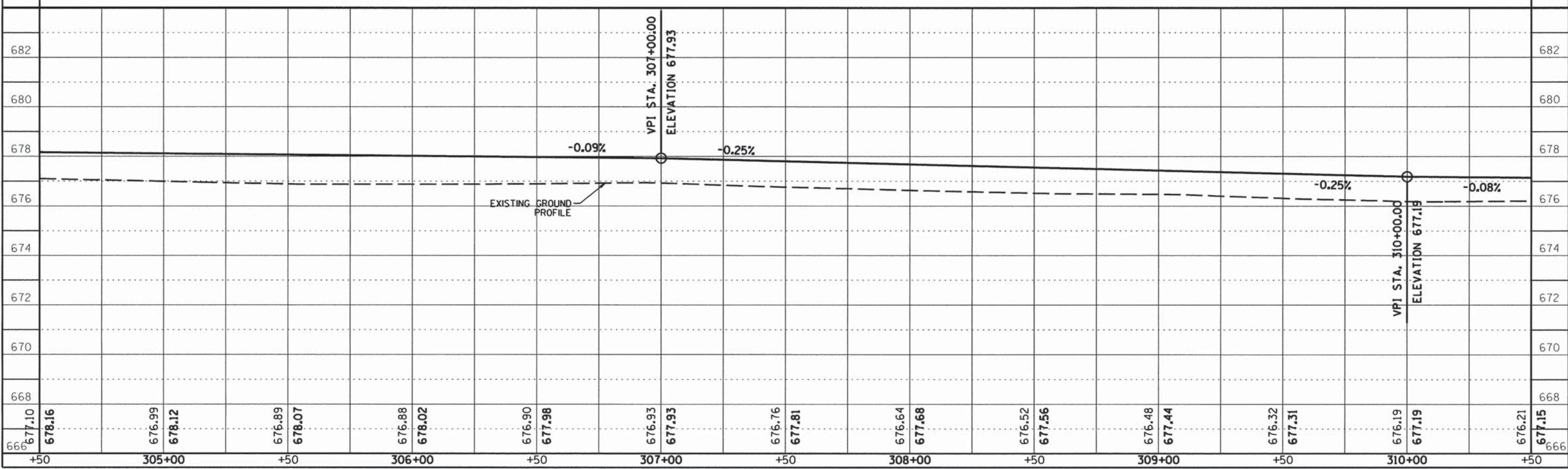

CONTRACT NO. 91520

ROUTE NO.	SECTION	COUNTY	TOTAL SHEETS	SHEET NO.
KICKAPOO TRAIL	08-F3000-02-BT	CHAMPAIGN	262	85
STA.	TO STA.			
F.H.W.A. REG.	ILLINOIS PROJECT			

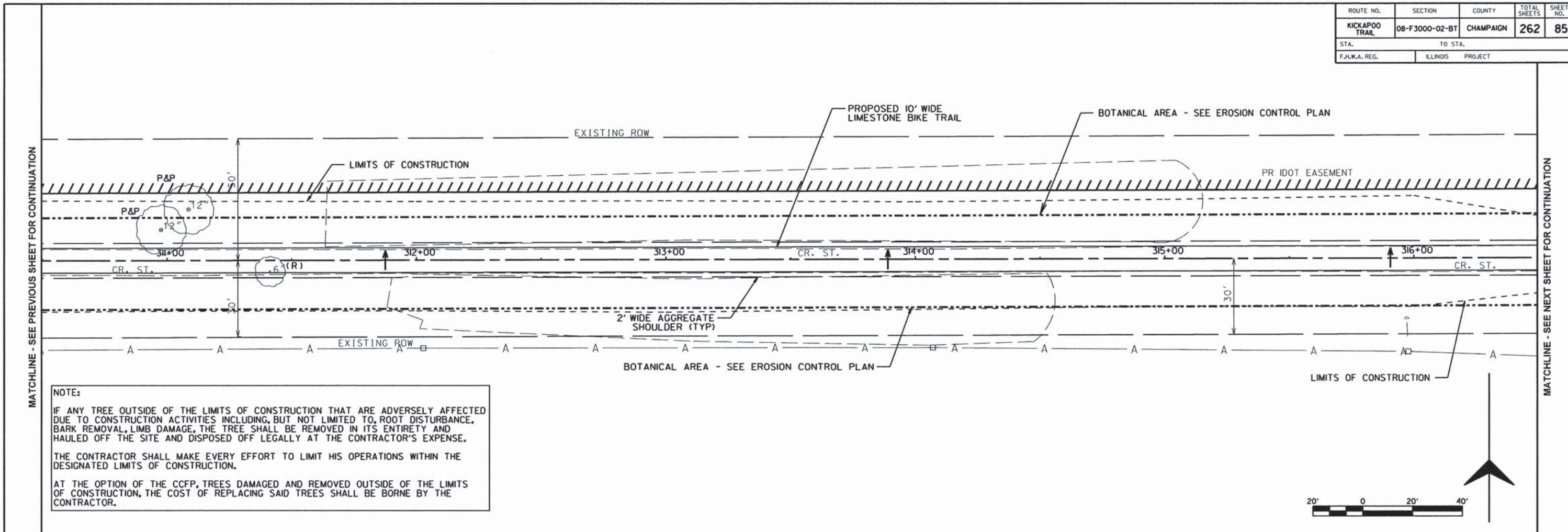

**NOTE:**  
 IF ANY TREE OUTSIDE OF THE LIMITS OF CONSTRUCTION THAT ARE ADVERSELY AFFECTED DUE TO CONSTRUCTION ACTIVITIES INCLUDING, BUT NOT LIMITED TO, ROOT DISTURBANCE, BARK REMOVAL, LIMB DAMAGE, THE TREE SHALL BE REMOVED IN ITS ENTIRETY AND HAULED OFF THE SITE AND DISPOSED OFF LEGALLY AT THE CONTRACTOR'S EXPENSE.  
 THE CONTRACTOR SHALL MAKE EVERY EFFORT TO LIMIT HIS OPERATIONS WITHIN THE DESIGNATED LIMITS OF CONSTRUCTION.  
 AT THE OPTION OF THE CCFP, TREES DAMAGED AND REMOVED OUTSIDE OF THE LIMITS OF CONSTRUCTION, THE COST OF REPLACING SAID TREES SHALL BE BORNE BY THE CONTRACTOR.

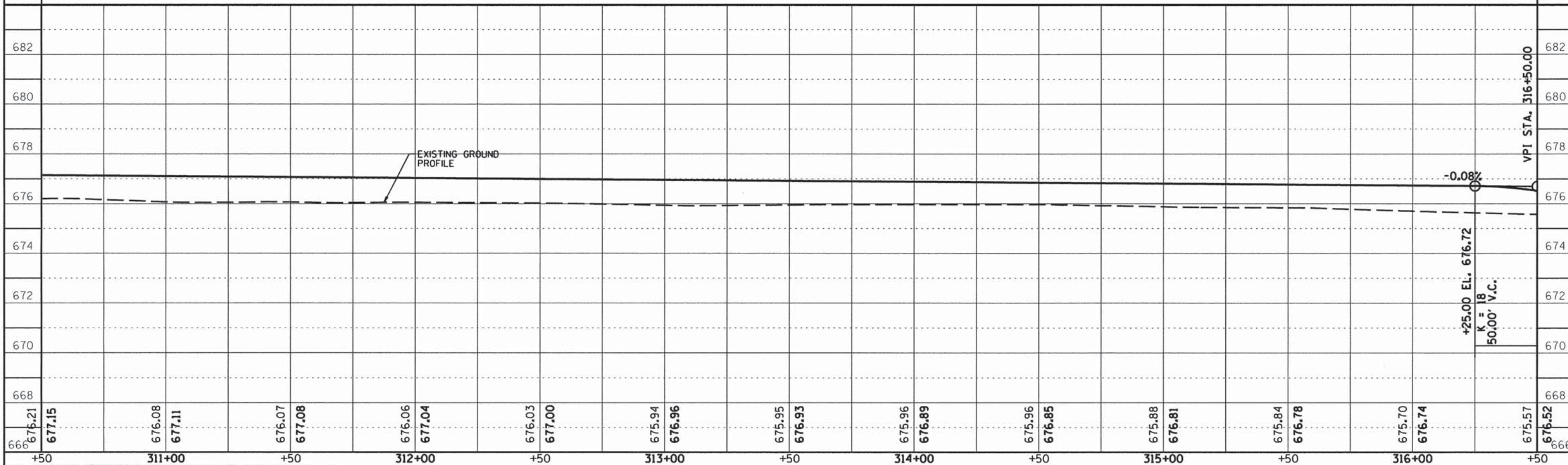

CONTRACT NO. 91520

ROUTE NO.	SECTION	COUNTY	TOTAL SHEETS	SHEET NO.
KICKAPOO TRAIL	08-F3000-02-BT	CHAMPAIGN	262	86
STA.	TO STA.			
F.H.W.A. REG.	ILLINOIS	PROJECT		



**NOTE:**  
 IF ANY TREE OUTSIDE OF THE LIMITS OF CONSTRUCTION THAT ARE ADVERSELY AFFECTED DUE TO CONSTRUCTION ACTIVITIES INCLUDING, BUT NOT LIMITED TO, ROOT DISTURBANCE, BARK REMOVAL, LIMB DAMAGE, THE TREE SHALL BE REMOVED IN ITS ENTIRETY AND HAULED OFF THE SITE AND DISPOSED OFF LEGALLY AT THE CONTRACTOR'S EXPENSE.  
 THE CONTRACTOR SHALL MAKE EVERY EFFORT TO LIMIT HIS OPERATIONS WITHIN THE DESIGNATED LIMITS OF CONSTRUCTION.  
 AT THE OPTION OF THE CCFP, TREES DAMAGED AND REMOVED OUTSIDE OF THE LIMITS OF CONSTRUCTION, THE COST OF REPLACING SAID TREES SHALL BE BORNE BY THE CONTRACTOR.

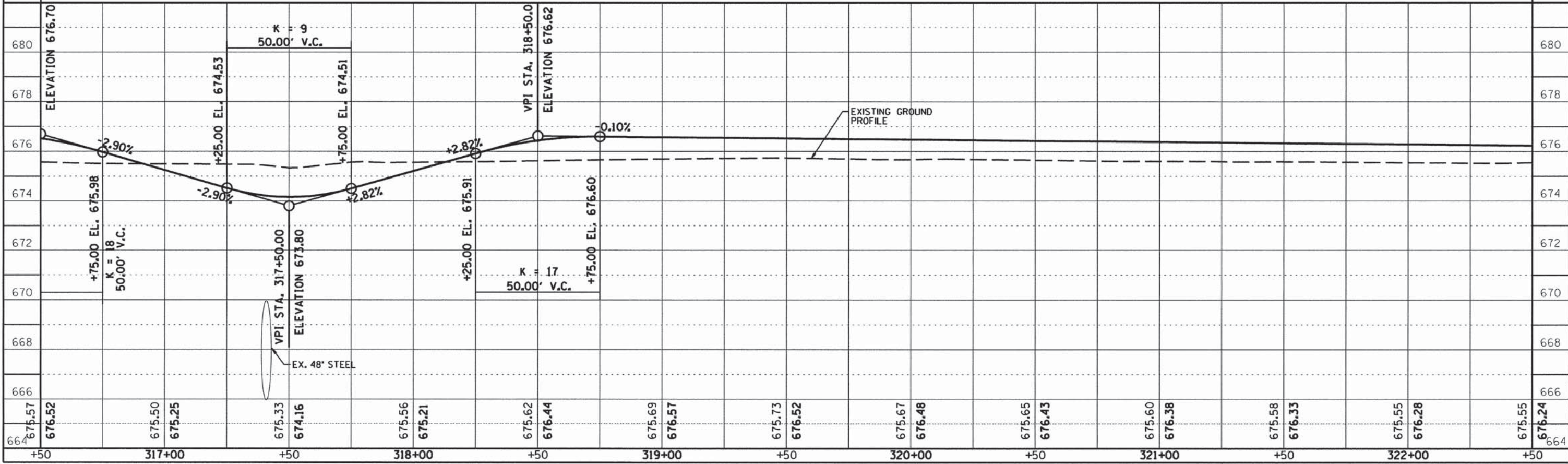
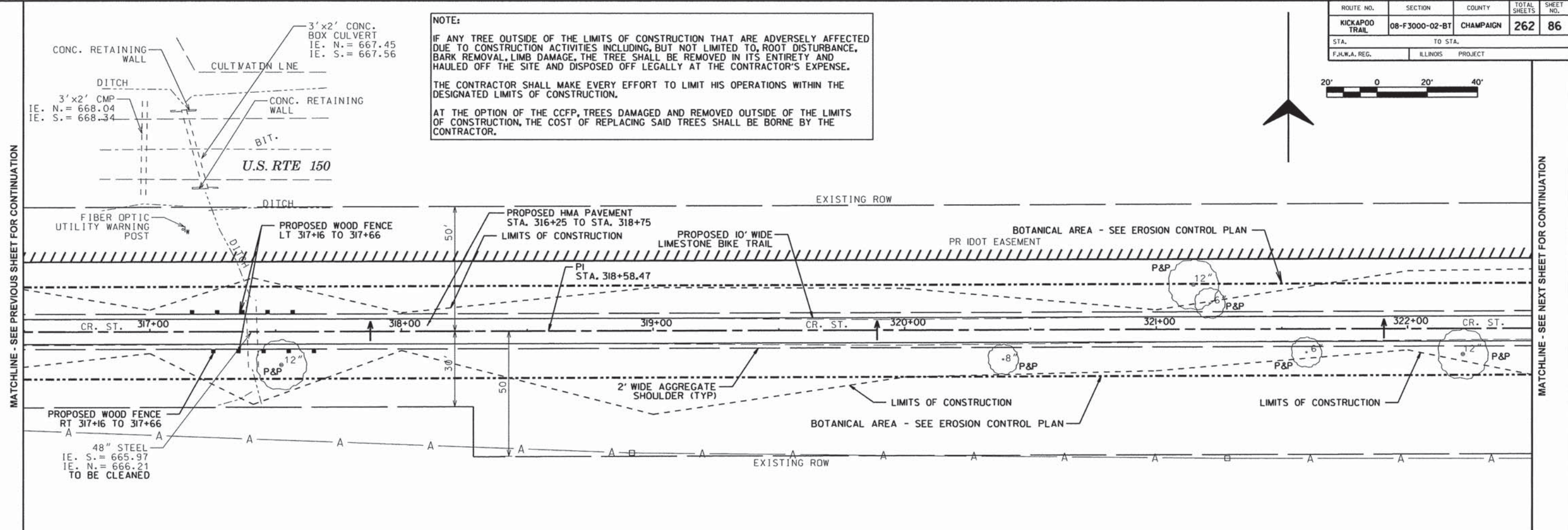

CONTRACT NO. 91520

ROUTE NO.	SECTION	COUNTY	TOTAL SHEETS	SHEET NO.
KICKAPOO TRAIL	08-F3000-02-BT	CHAMPAIGN	262	87
STA.	TO STA.			
F.H.W.A. REG.	ILLINOIS	PROJECT		



**NOTE:**  
 IF ANY TREE OUTSIDE OF THE LIMITS OF CONSTRUCTION THAT ARE ADVERSELY AFFECTED DUE TO CONSTRUCTION ACTIVITIES INCLUDING, BUT NOT LIMITED TO, ROOT DISTURBANCE, BARK REMOVAL, LIMB DAMAGE, THE TREE SHALL BE REMOVED IN ITS ENTIRETY AND HAULED OFF THE SITE AND DISPOSED OFF LEGALLY AT THE CONTRACTOR'S EXPENSE.  
 THE CONTRACTOR SHALL MAKE EVERY EFFORT TO LIMIT HIS OPERATIONS WITHIN THE DESIGNATED LIMITS OF CONSTRUCTION.  
 AT THE OPTION OF THE CCFP, TREES DAMAGED AND REMOVED OUTSIDE OF THE LIMITS OF CONSTRUCTION, THE COST OF REPLACING SAID TREES SHALL BE BORNE BY THE CONTRACTOR.

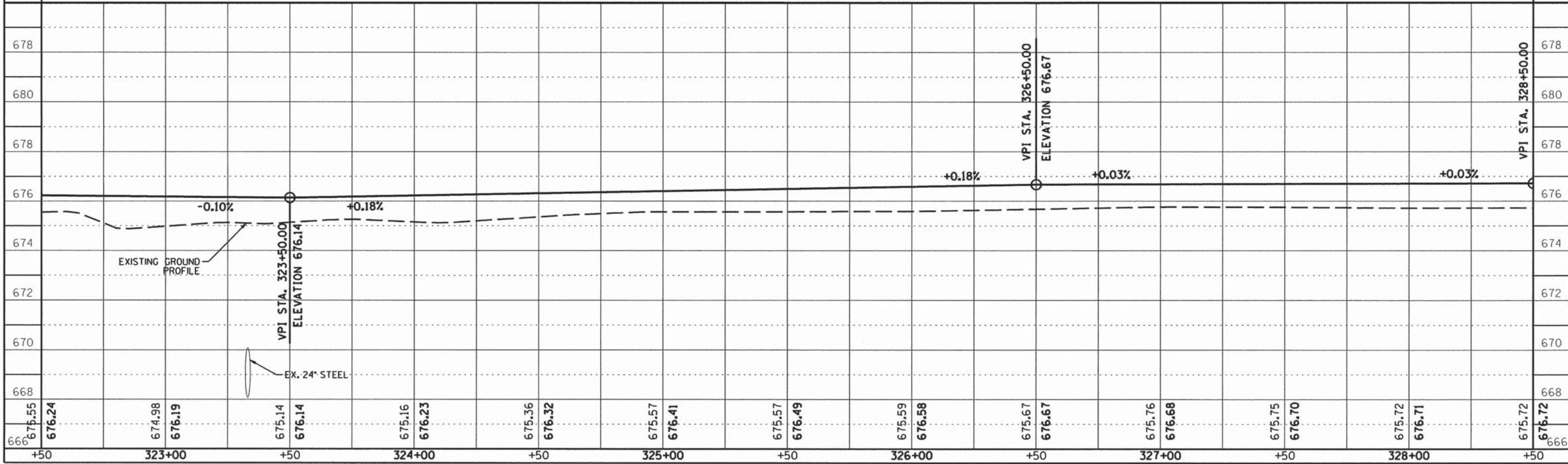
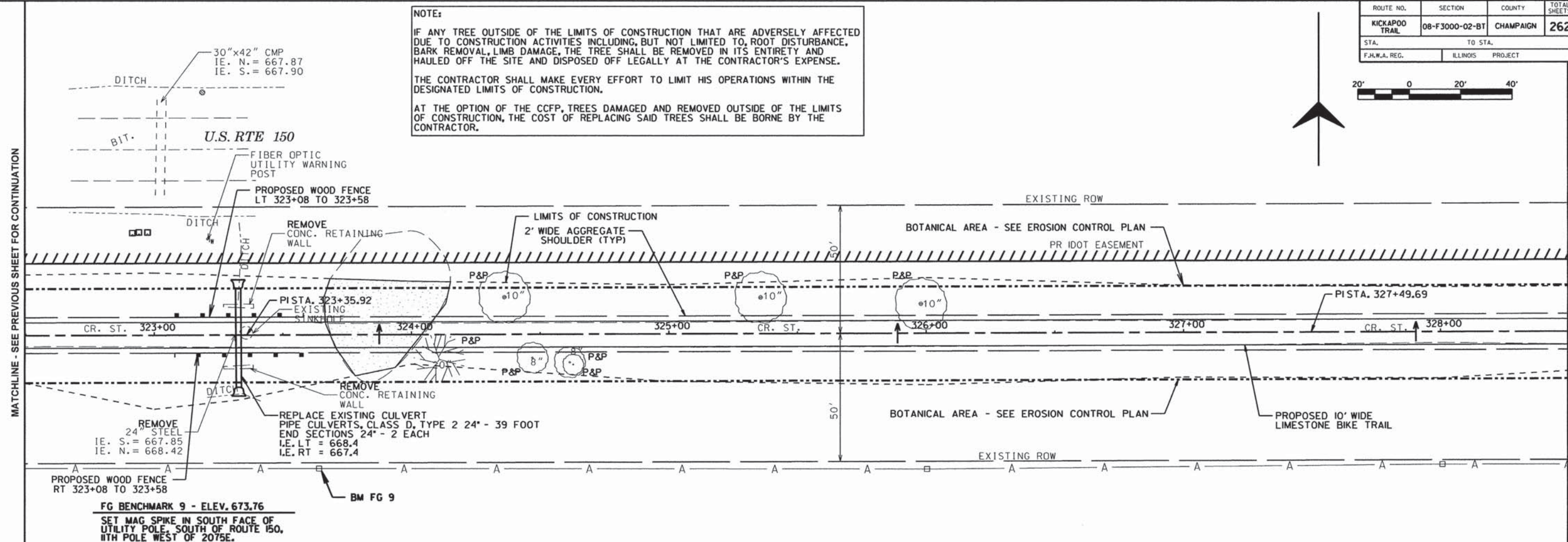

**CONTRACT NO. 91520**

ROUTE NO.	SECTION	COUNTY	TOTAL SHEETS	SHEET NO.
KICKAPOO TRAIL	08-F3000-02-BT	CHAMPAIGN	262	88
STA.	TO STA.			
F.H.W.A. REG.	ILLINOIS	PROJECT		

**NOTE:**  
 IF ANY TREE OUTSIDE OF THE LIMITS OF CONSTRUCTION THAT ARE ADVERSELY AFFECTED DUE TO CONSTRUCTION ACTIVITIES INCLUDING, BUT NOT LIMITED TO, ROOT DISTURBANCE, BARK REMOVAL, LIMB DAMAGE, THE TREE SHALL BE REMOVED IN ITS ENTIRETY AND HAULED OFF THE SITE AND DISPOSED OFF LEGALLY AT THE CONTRACTOR'S EXPENSE.  
 THE CONTRACTOR SHALL MAKE EVERY EFFORT TO LIMIT HIS OPERATIONS WITHIN THE DESIGNATED LIMITS OF CONSTRUCTION.  
 AT THE OPTION OF THE CCFP, TREES DAMAGED AND REMOVED OUTSIDE OF THE LIMITS OF CONSTRUCTION, THE COST OF REPLACING SAID TREES SHALL BE BORNE BY THE CONTRACTOR.



MATCHLINE - SEE PREVIOUS SHEET FOR CONTINUATION

MATCHLINE - SEE NEXT SHEET FOR CONTINUATION

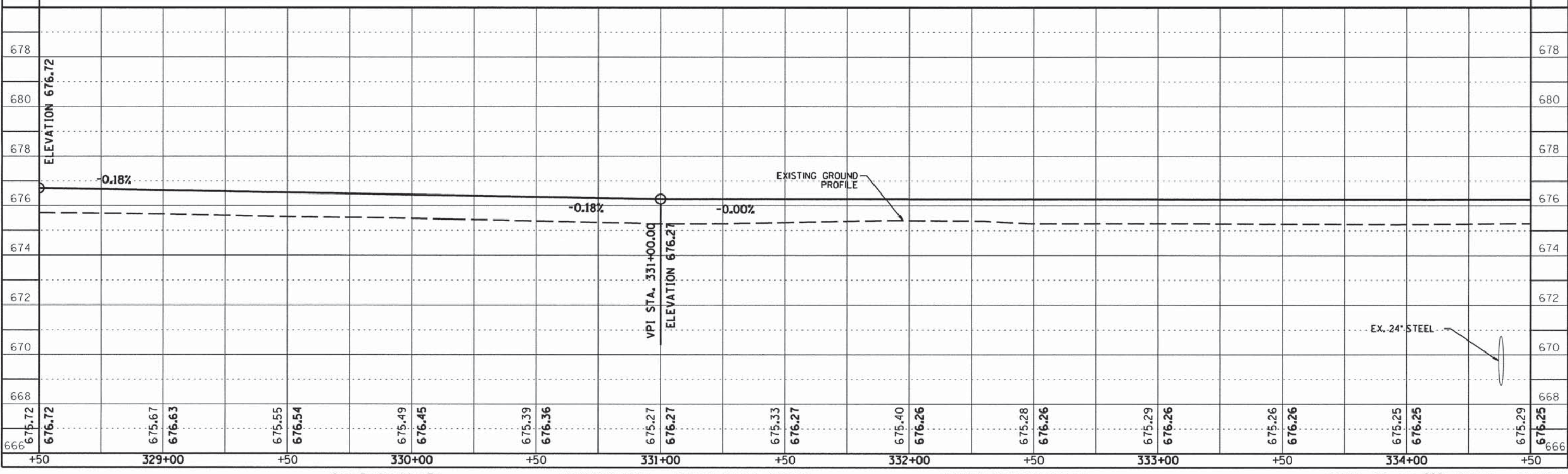
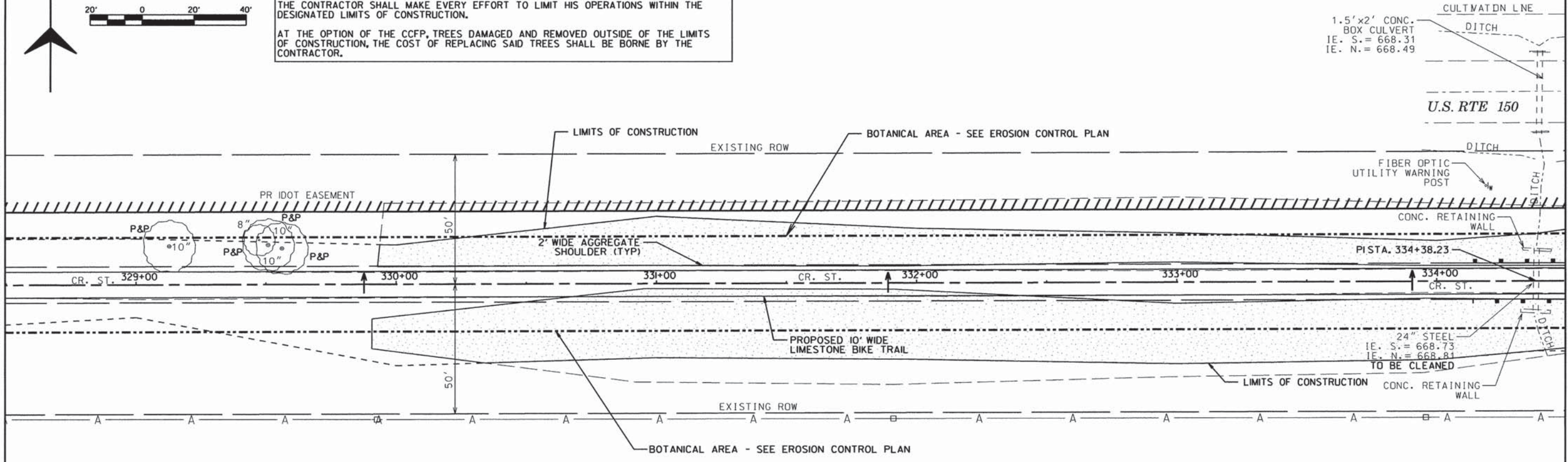

CONTRACT NO. 91520

ROUTE NO.	SECTION	COUNTY	TOTAL SHEETS	SHEET NO.
KICKAPOO TRAIL	08-F3000-02-BT	CHAMPAIGN	262	89
STA. _____ TO STA. _____		F.I.W.A. REG. _____ ILLINOIS PROJECT _____		



**NOTE:**  
 IF ANY TREE OUTSIDE OF THE LIMITS OF CONSTRUCTION THAT ARE ADVERSELY AFFECTED DUE TO CONSTRUCTION ACTIVITIES INCLUDING, BUT NOT LIMITED TO, ROOT DISTURBANCE, BARK REMOVAL, LIMB DAMAGE, THE TREE SHALL BE REMOVED IN ITS ENTIRETY AND HAULED OFF THE SITE AND DISPOSED OFF LEGALLY AT THE CONTRACTOR'S EXPENSE.  
 THE CONTRACTOR SHALL MAKE EVERY EFFORT TO LIMIT HIS OPERATIONS WITHIN THE DESIGNATED LIMITS OF CONSTRUCTION.  
 AT THE OPTION OF THE CCFP, TREES DAMAGED AND REMOVED OUTSIDE OF THE LIMITS OF CONSTRUCTION, THE COST OF REPLACING SAID TREES SHALL BE BORNE BY THE CONTRACTOR.

MATCHLINE - SEE PREVIOUS SHEET FOR CONTINUATION

MATCHLINE - SEE NEXT SHEET FOR CONTINUATION

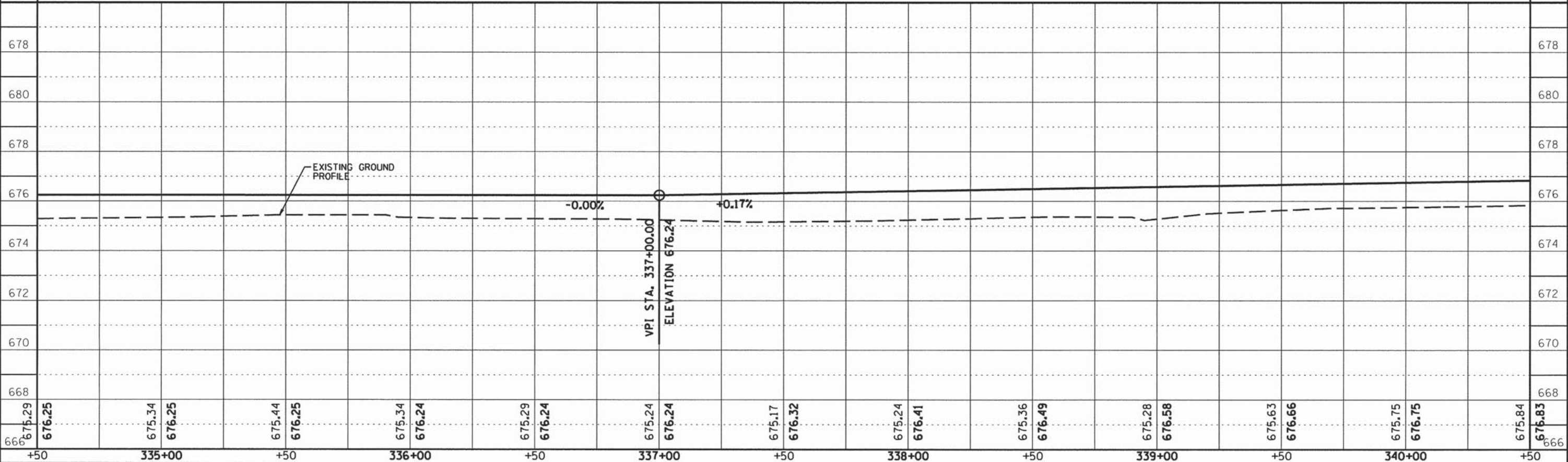
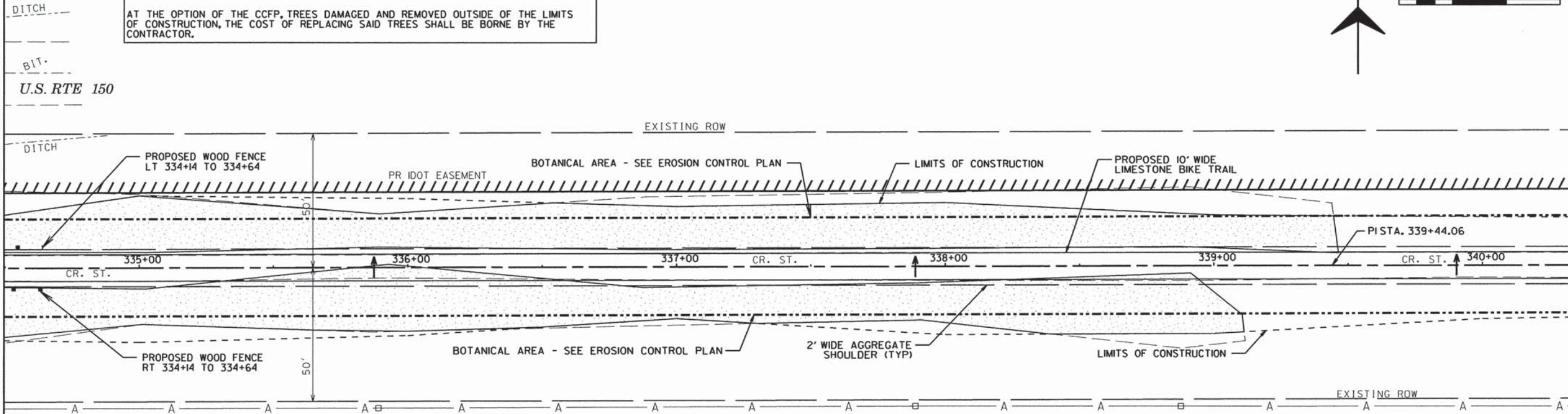

CONTRACT NO. 91520

ROUTE NO.	SECTION	COUNTY	TOTAL SHEETS	SHEET NO.
KICKAPOO TRAIL	08-F3000-02-BT	CHAMPAIGN	262	90
STA.	TO STA.			
F.H.W.A. REG.	ILLINOIS PROJECT			

U.S. RTE 150

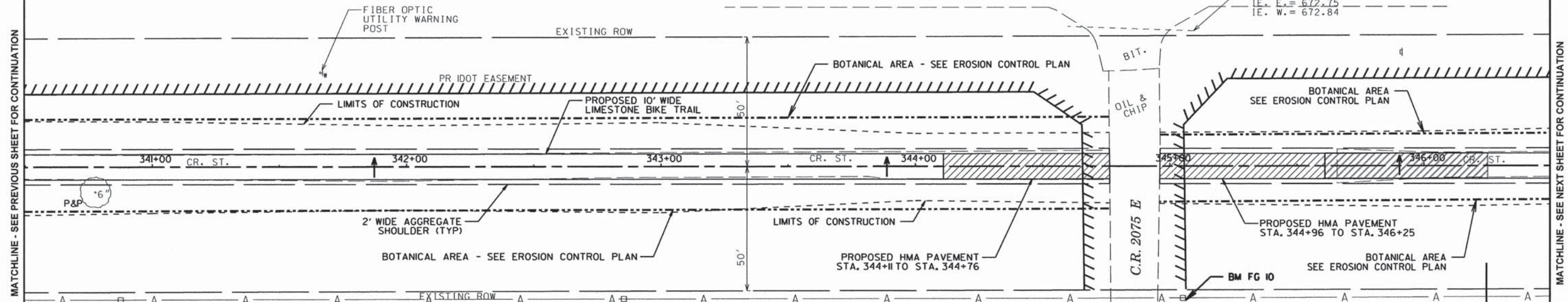

**NOTE:**  
 IF ANY TREE OUTSIDE OF THE LIMITS OF CONSTRUCTION THAT ARE ADVERSELY AFFECTED DUE TO CONSTRUCTION ACTIVITIES INCLUDING, BUT NOT LIMITED TO, ROOT DISTURBANCE, BARK REMOVAL, LIMB DAMAGE, THE TREE SHALL BE REMOVED IN ITS ENTIRETY AND HAULED OFF THE SITE AND DISPOSED OFF LEGALLY AT THE CONTRACTOR'S EXPENSE.  
 THE CONTRACTOR SHALL MAKE EVERY EFFORT TO LIMIT HIS OPERATIONS WITHIN THE DESIGNATED LIMITS OF CONSTRUCTION.  
 AT THE OPTION OF THE CCFP, TREES DAMAGED AND REMOVED OUTSIDE OF THE LIMITS OF CONSTRUCTION, THE COST OF REPLACING SAID TREES SHALL BE BORNE BY THE CONTRACTOR.

FG BENCHMARK 10 - ELEV. 676.2  
 SET MAG SPIKE IN NORTH FACE OF UTILITY POLE, FIRST POLE SOUTH OF ROUTE 150, EAST SIDE OF 2075E.

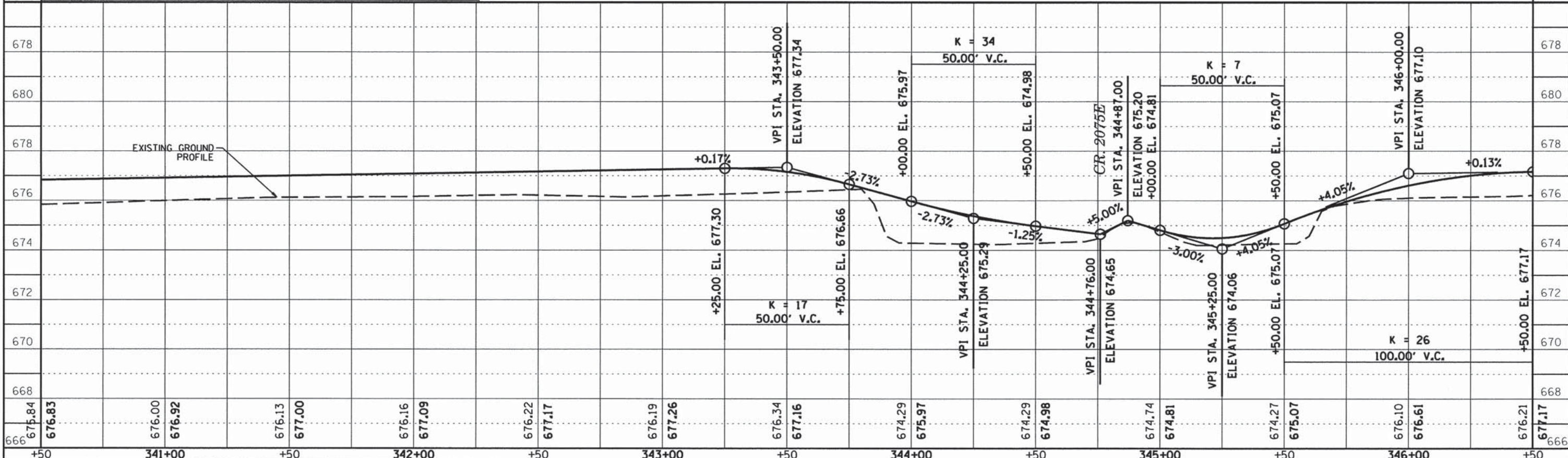

CONTRACT NO. 91520

ROUTE NO.	SECTION	COUNTY	TOTAL SHEETS	SHEET NO.
KICKAPOO TRAIL	08-F3000-02-BT	CHAMPAIGN	262	91
STA.	TO STA.			
F.H.W.A. REG.	ILLINOIS	PROJECT		

NOTE:  
 IF ANY TREE OUTSIDE OF THE LIMITS OF CONSTRUCTION THAT ARE ADVERSELY AFFECTED DUE TO CONSTRUCTION ACTIVITIES INCLUDING, BUT NOT LIMITED TO, ROOT DISTURBANCE, BARK REMOVAL, LIMB DAMAGE, THE TREE SHALL BE REMOVED IN ITS ENTIRETY AND HAULED OFF THE SITE AND DISPOSED OFF LEGALLY AT THE CONTRACTOR'S EXPENSE.  
 THE CONTRACTOR SHALL MAKE EVERY EFFORT TO LIMIT HIS OPERATIONS WITHIN THE DESIGNATED LIMITS OF CONSTRUCTION.  
 AT THE OPTION OF THE CCFP, TREES DAMAGED AND REMOVED OUTSIDE OF THE LIMITS OF CONSTRUCTION, THE COST OF REPLACING SAID TREES SHALL BE BORNE BY THE CONTRACTOR.

CURVE 7  
 P.I. STA. 356+29.92  
 $\Delta = 11^{\circ}44'51''$   
 $D = 1^{\circ}02'30''$   
 $T = 565.83'$   
 $R = 5,500.00'$   
 $L = 1,127.68'$   
 $E = 29.03'$   
 P.C. STA. 350+64.09  
 P.T. STA. 361+91.77

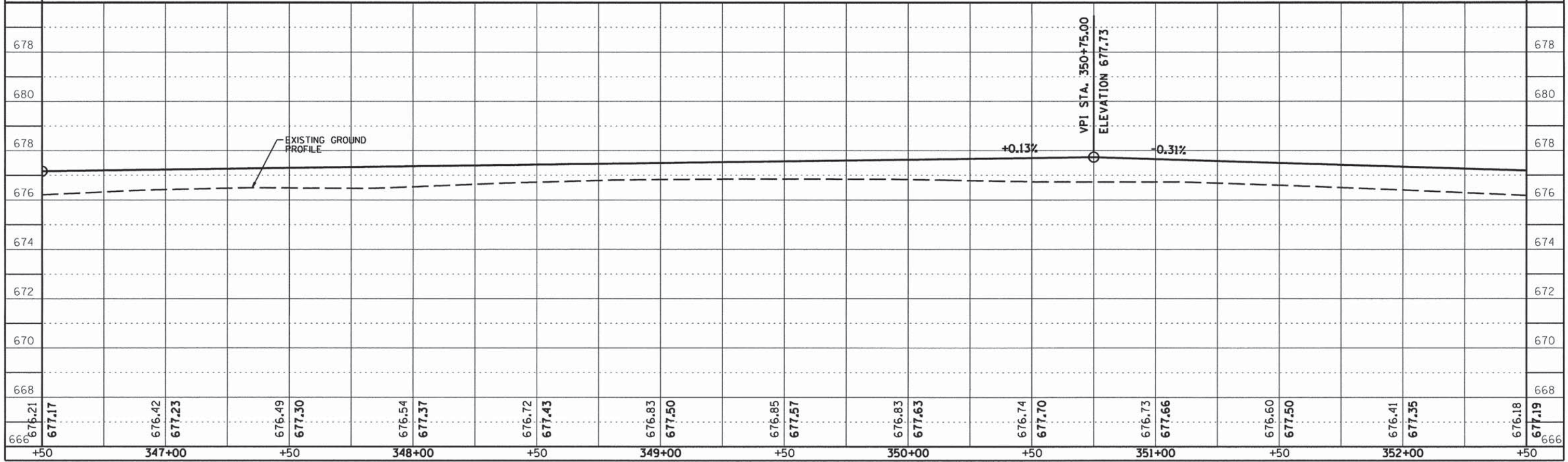
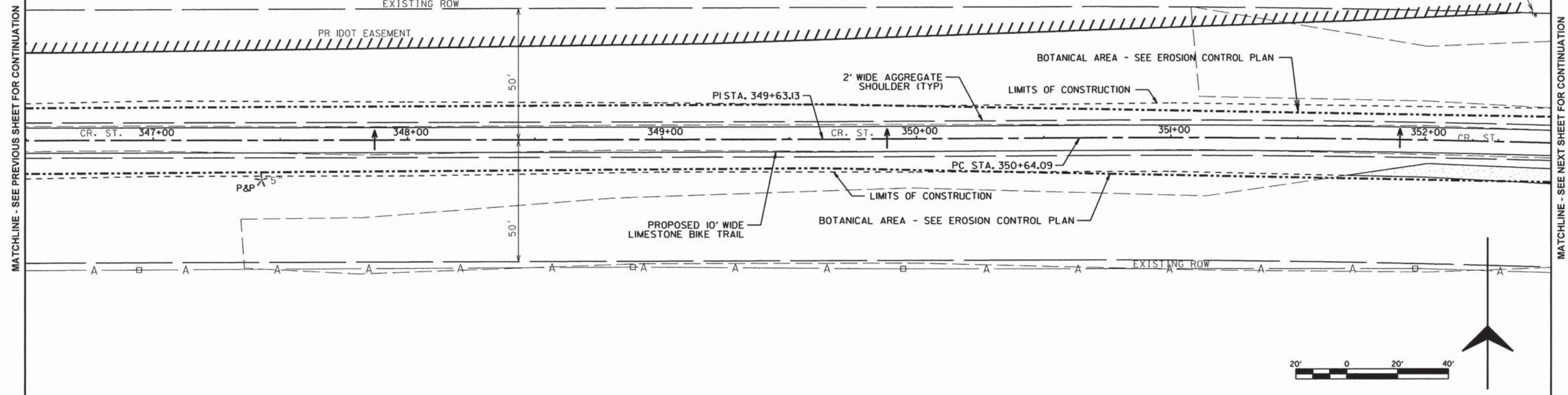



**CONTRACT NO. 91520**

ROUTE NO.	SECTION	COUNTY	TOTAL SHEETS	SHEET NO.
KICKAPOO TRAIL	08-F3000-02-BT	CHAMPAIGN	262	92
STA. _____ TO STA. _____		F.H.W.A. REG. _____ ILLINOIS PROJECT _____		



**NOTE:**  
 IF ANY TREE OUTSIDE OF THE LIMITS OF CONSTRUCTION THAT ARE ADVERSELY AFFECTED DUE TO CONSTRUCTION ACTIVITIES INCLUDING, BUT NOT LIMITED TO, ROOT DISTURBANCE, BARK REMOVAL, LIMB DAMAGE, THE TREE SHALL BE REMOVED IN ITS ENTIRETY AND HAULED OFF THE SITE AND DISPOSED OFF LEGALLY AT THE CONTRACTOR'S EXPENSE.  
 THE CONTRACTOR SHALL MAKE EVERY EFFORT TO LIMIT HIS OPERATIONS WITHIN THE DESIGNATED LIMITS OF CONSTRUCTION.  
 AT THE OPTION OF THE CCFP, TREES DAMAGED AND REMOVED OUTSIDE OF THE LIMITS OF CONSTRUCTION, THE COST OF REPLACING SAID TREES SHALL BE BORNE BY THE CONTRACTOR.

**CURVE 7**  
 P.I. STA. 356+29.92  
 $\Delta = 11^{\circ}44'51''$   
 $D = 1^{\circ}02'30''$   
 $T = 565.83'$   
 $R = 5,500.00'$   
 $L = 1,127.68'$   
 $E = 29.03'$   
 P.C. STA. 350+64.09  
 P.T. STA. 361+91.77

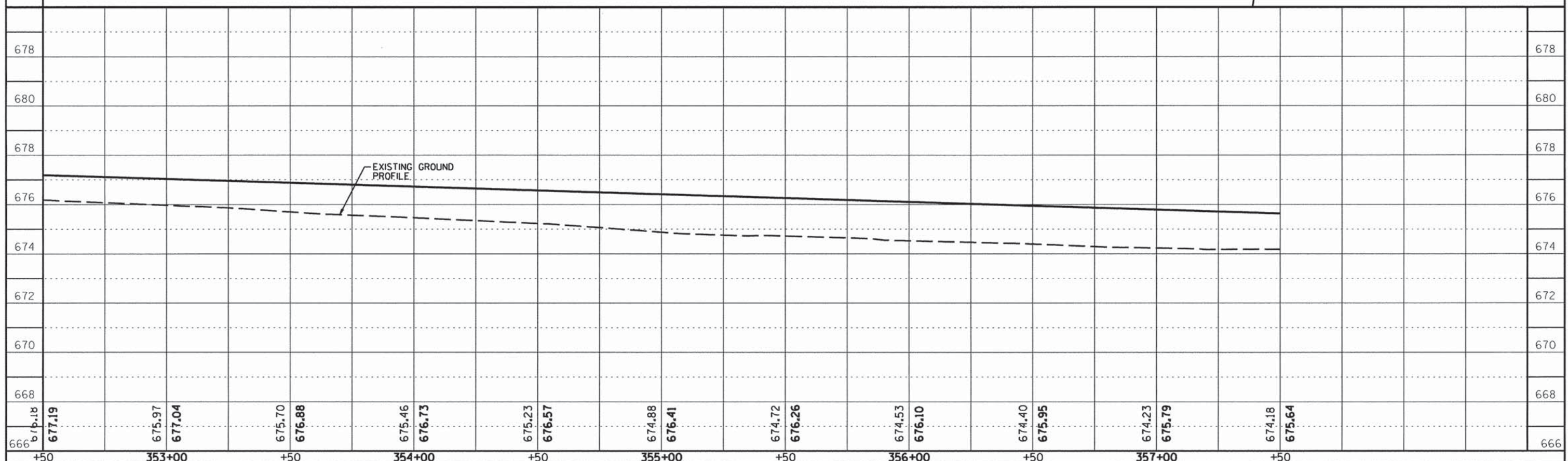
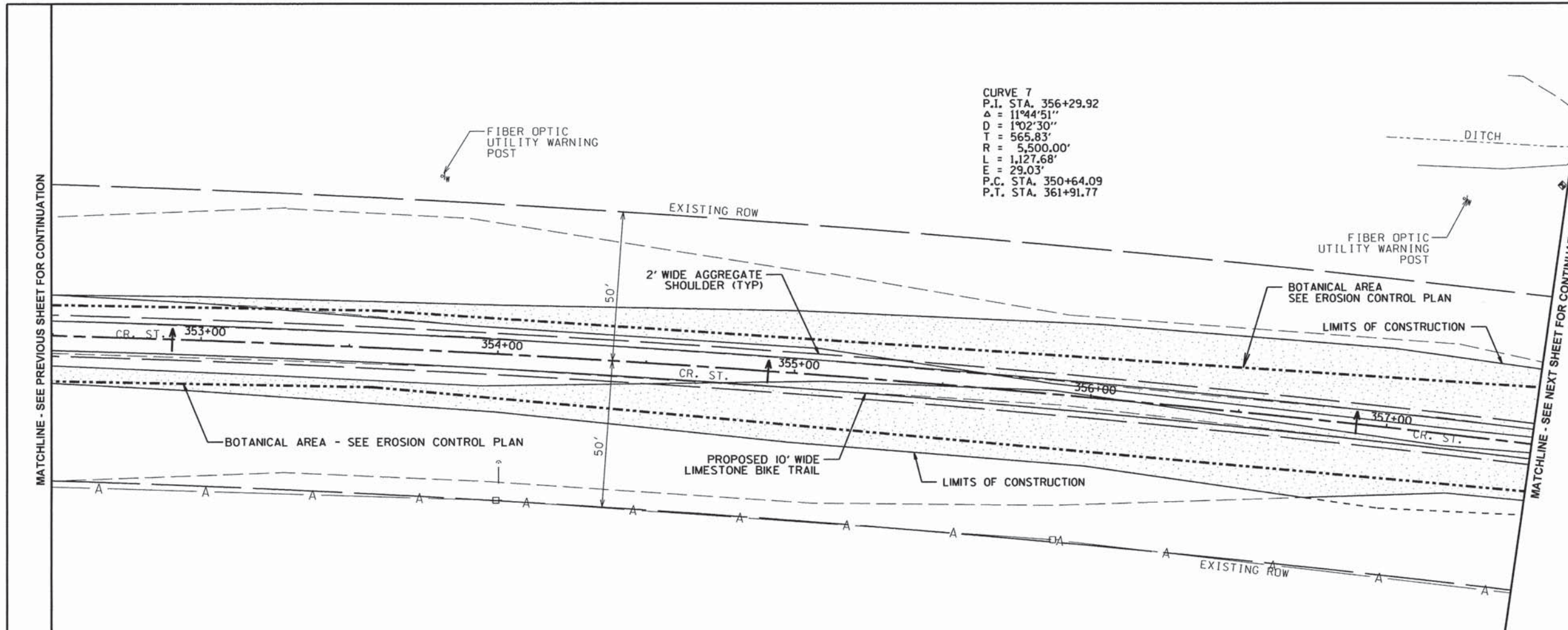

CONTRACT NO. 91520

ROUTE NO.	SECTION	COUNTY	TOTAL SHEETS	SHEET NO.
KICKAPOO TRAIL	08-F3000-02-BT	CHAMPAIGN	262	93
STA.	TO STA.			
F.J.W.A. REG.	ILLINOIS PROJECT			

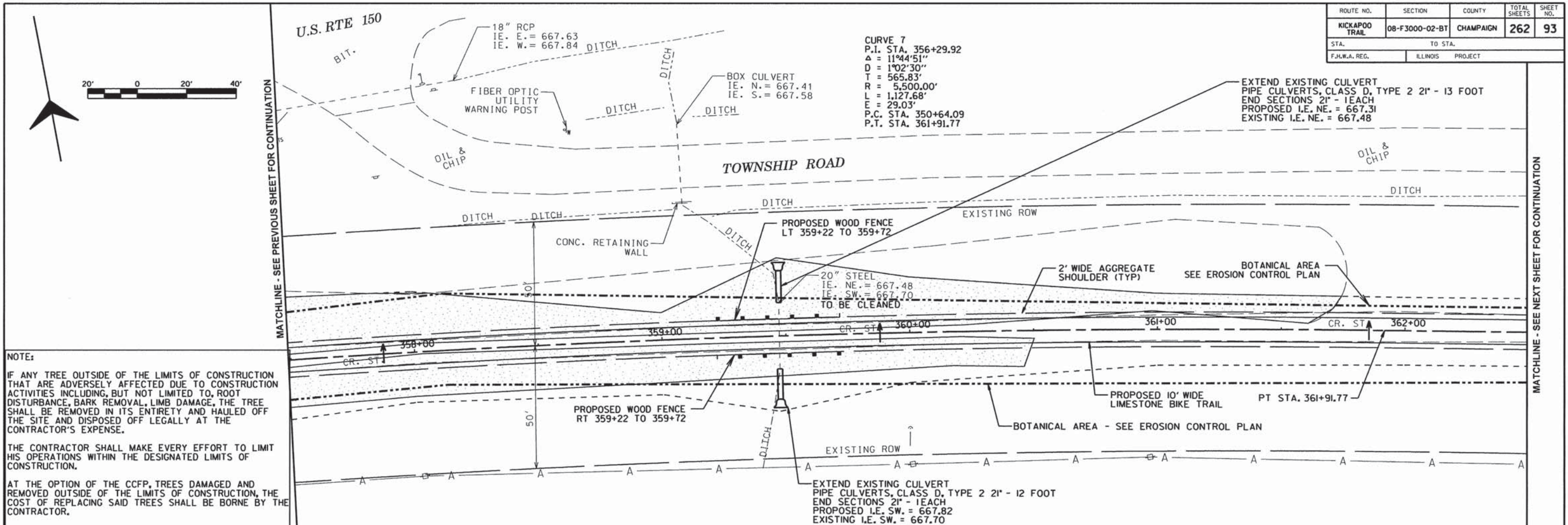

**NOTE:**

IF ANY TREE OUTSIDE OF THE LIMITS OF CONSTRUCTION THAT ARE ADVERSELY AFFECTED DUE TO CONSTRUCTION ACTIVITIES INCLUDING, BUT NOT LIMITED TO, ROOT DISTURBANCE, BARK REMOVAL, LIMB DAMAGE, THE TREE SHALL BE REMOVED IN ITS ENTIRETY AND HAULED OFF THE SITE AND DISPOSED OFF LEGALLY AT THE CONTRACTOR'S EXPENSE.

THE CONTRACTOR SHALL MAKE EVERY EFFORT TO LIMIT HIS OPERATIONS WITHIN THE DESIGNATED LIMITS OF CONSTRUCTION.

AT THE OPTION OF THE CCFP, TREES DAMAGED AND REMOVED OUTSIDE OF THE LIMITS OF CONSTRUCTION, THE COST OF REPLACING SAID TREES SHALL BE BORNE BY THE CONTRACTOR.

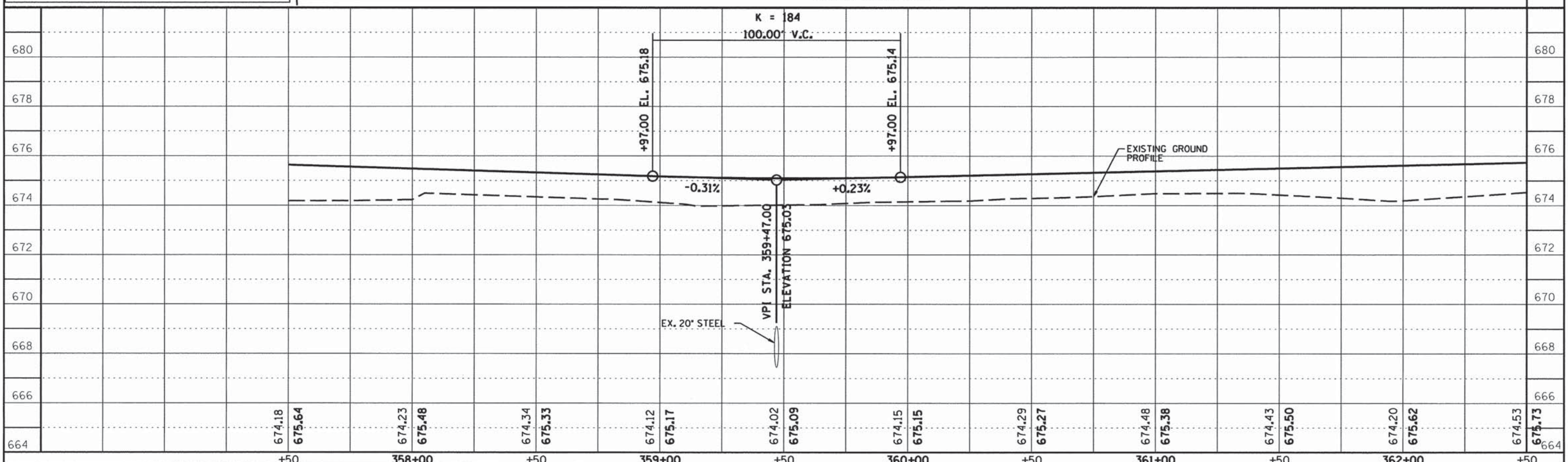

CONTRACT NO. 91520

ROUTE NO.	SECTION	COUNTY	TOTAL SHEETS	SHEET NO.
KICKAPOO TRAIL	08-F3000-02-BT	CHAMPAIGN	262	94
STA.	TO STA.			
F.H.W.A. REG.	ILLINOIS	PROJECT		

**NOTE:**  
 IF ANY TREE OUTSIDE OF THE LIMITS OF CONSTRUCTION THAT ARE ADVERSELY AFFECTED DUE TO CONSTRUCTION ACTIVITIES INCLUDING, BUT NOT LIMITED TO, ROOT DISTURBANCE, BARK REMOVAL, LIMB DAMAGE, THE TREE SHALL BE REMOVED IN ITS ENTIRETY AND HAULED OFF THE SITE AND DISPOSED OFF LEGALLY AT THE CONTRACTOR'S EXPENSE.  
 THE CONTRACTOR SHALL MAKE EVERY EFFORT TO LIMIT HIS OPERATIONS WITHIN THE DESIGNATED LIMITS OF CONSTRUCTION.  
 AT THE OPTION OF THE CCFP, TREES DAMAGED AND REMOVED OUTSIDE OF THE LIMITS OF CONSTRUCTION, THE COST OF REPLACING SAID TREES SHALL BE BORNE BY THE CONTRACTOR.

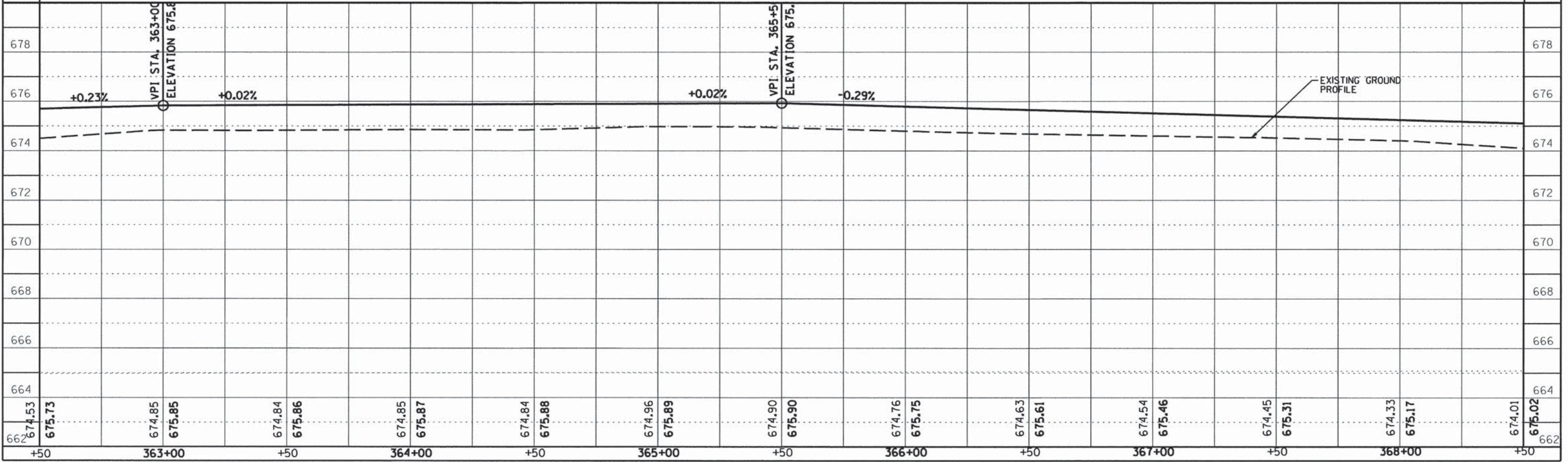
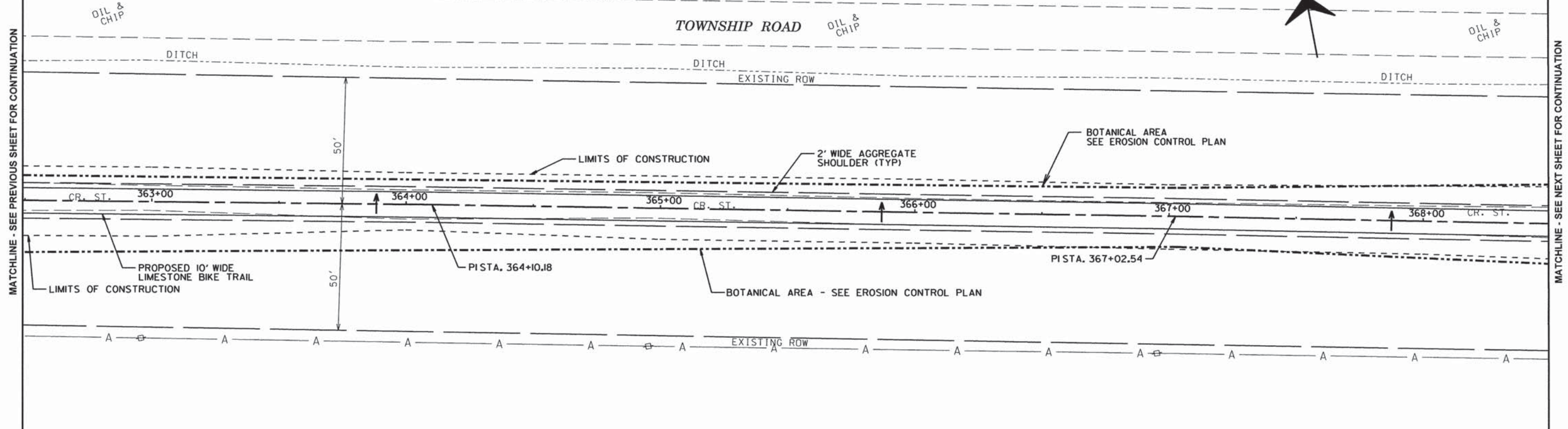

CONTRACT NO. 91520

ROUTE NO.	SECTION	COUNTY	TOTAL SHEETS	SHEET NO.
KICKAPOO TRAIL	08-F3000-02-BT	CHAMPAIGN	262	95
STA.	TO STA.			
F.H.W.A. REG.	ILLINOIS PROJECT			

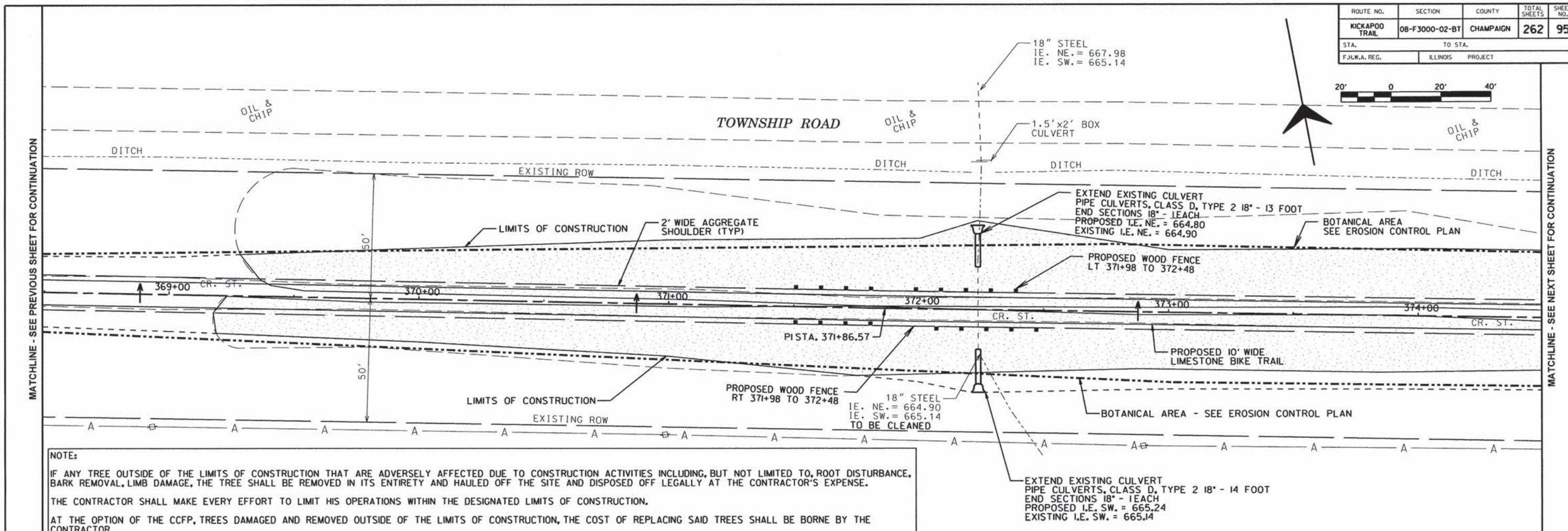

**NOTE:**  
 IF ANY TREE OUTSIDE OF THE LIMITS OF CONSTRUCTION THAT ARE ADVERSELY AFFECTED DUE TO CONSTRUCTION ACTIVITIES INCLUDING, BUT NOT LIMITED TO, ROOT DISTURBANCE, BARK REMOVAL, LIMB DAMAGE, THE TREE SHALL BE REMOVED IN ITS ENTIRETY AND HAULED OFF THE SITE AND DISPOSED OFF LEGALLY AT THE CONTRACTOR'S EXPENSE.  
 THE CONTRACTOR SHALL MAKE EVERY EFFORT TO LIMIT HIS OPERATIONS WITHIN THE DESIGNATED LIMITS OF CONSTRUCTION.  
 AT THE OPTION OF THE CCFP, TREES DAMAGED AND REMOVED OUTSIDE OF THE LIMITS OF CONSTRUCTION, THE COST OF REPLACING SAID TREES SHALL BE BORNE BY THE CONTRACTOR.

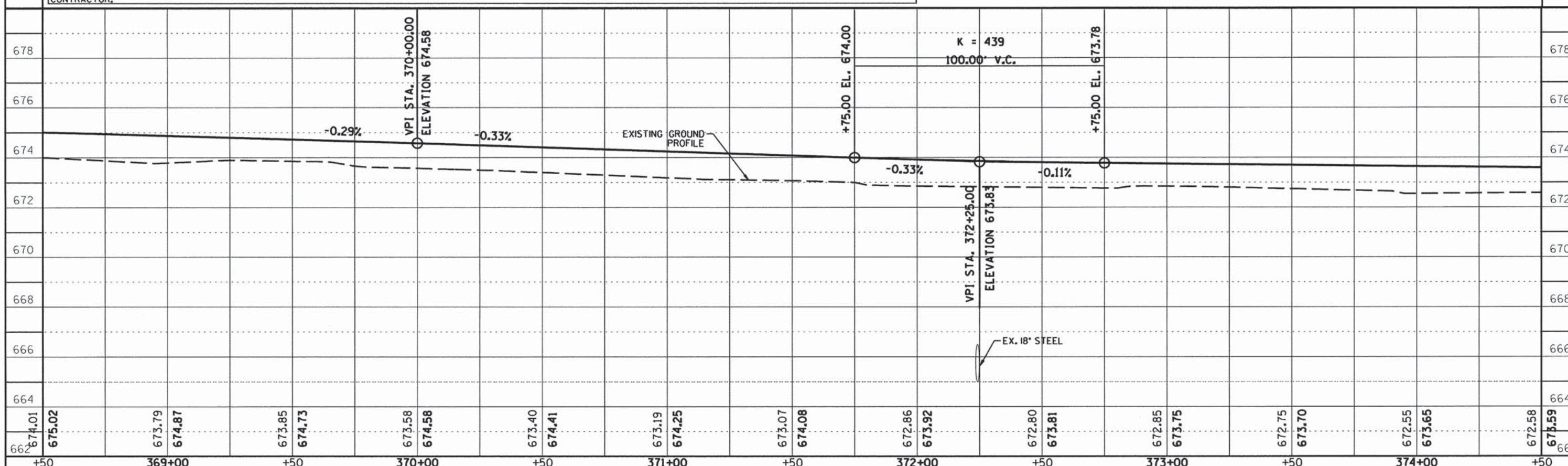

CONTRACT NO. 91520

ROUTE NO.	SECTION	COUNTY	TOTAL SHEETS	SHEET NO.
KICKAPOO TRAIL	08-F3000-02-BT	CHAMPAIGN	262	96
STA.	TO STA.			
F.H.W.A. REG.	ILLINOIS	PROJECT		



**NOTE:**  
 IF ANY TREE OUTSIDE OF THE LIMITS OF CONSTRUCTION THAT ARE ADVERSELY AFFECTED DUE TO CONSTRUCTION ACTIVITIES INCLUDING, BUT NOT LIMITED TO, ROOT DISTURBANCE, BARK REMOVAL, LIMB DAMAGE, THE TREE SHALL BE REMOVED IN ITS ENTIRETY AND HAULED OFF THE SITE AND DISPOSED OFF LEGALLY AT THE CONTRACTOR'S EXPENSE.  
 THE CONTRACTOR SHALL MAKE EVERY EFFORT TO LIMIT HIS OPERATIONS WITHIN THE DESIGNATED LIMITS OF CONSTRUCTION.  
 AT THE OPTION OF THE CCFP, TREES DAMAGED AND REMOVED OUTSIDE OF THE LIMITS OF CONSTRUCTION, THE COST OF REPLACING SAID TREES SHALL BE BORNE BY THE CONTRACTOR.

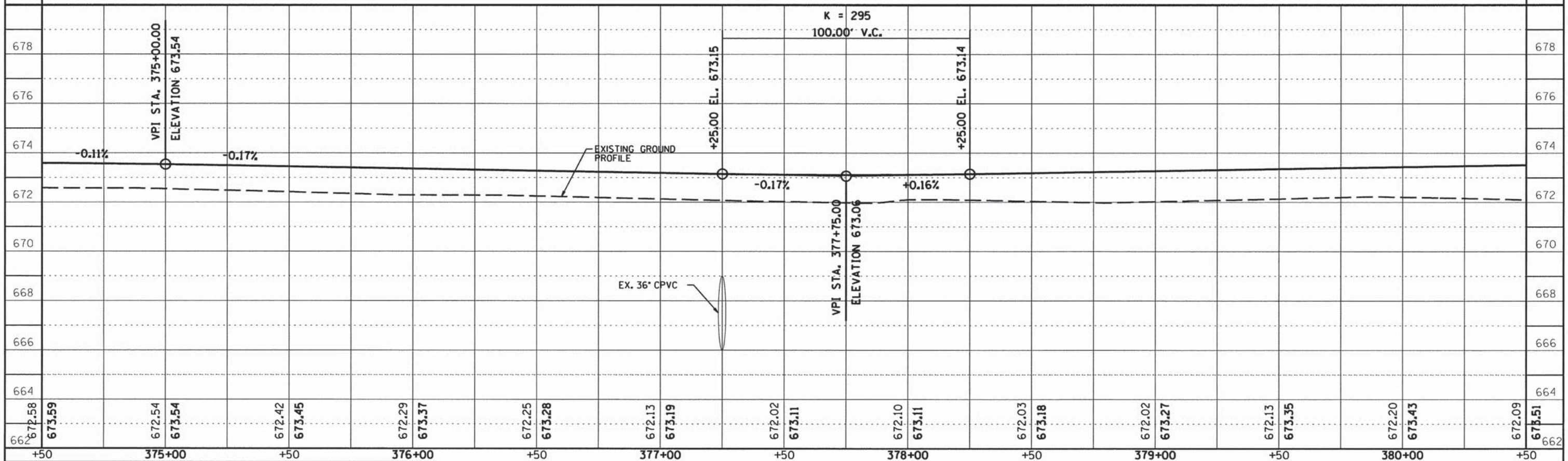
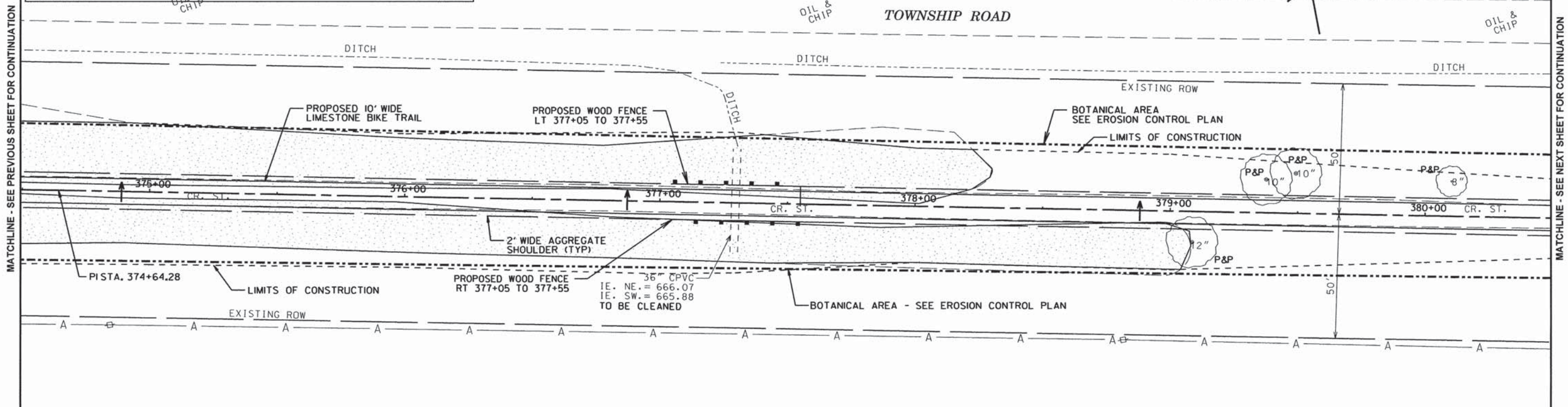

CONTRACT NO. 91520

ROUTE NO.	SECTION	COUNTY	TOTAL SHEETS	SHEET NO.
KICKAPOO TRAIL	08-F3000-02-BT	CHAMPAIGN	262	97
STA.		TO STA.		
F.H.W.A. REG.		ILLINOIS PROJECT		



**NOTE:**  
 IF ANY TREE OUTSIDE OF THE LIMITS OF CONSTRUCTION THAT ARE ADVERSELY AFFECTED DUE TO CONSTRUCTION ACTIVITIES INCLUDING, BUT NOT LIMITED TO, ROOT DISTURBANCE, BARK REMOVAL, LIMB DAMAGE, THE TREE SHALL BE REMOVED IN ITS ENTIRETY AND HAULED OFF THE SITE AND DISPOSED OFF LEGALLY AT THE CONTRACTOR'S EXPENSE.  
 THE CONTRACTOR SHALL MAKE EVERY EFFORT TO LIMIT HIS OPERATIONS WITHIN THE DESIGNATED LIMITS OF CONSTRUCTION.  
 AT THE OPTION OF THE CCFP, TREES DAMAGED AND REMOVED OUTSIDE OF THE LIMITS OF CONSTRUCTION, THE COST OF REPLACING SAID TREES SHALL BE BORNE BY THE CONTRACTOR.

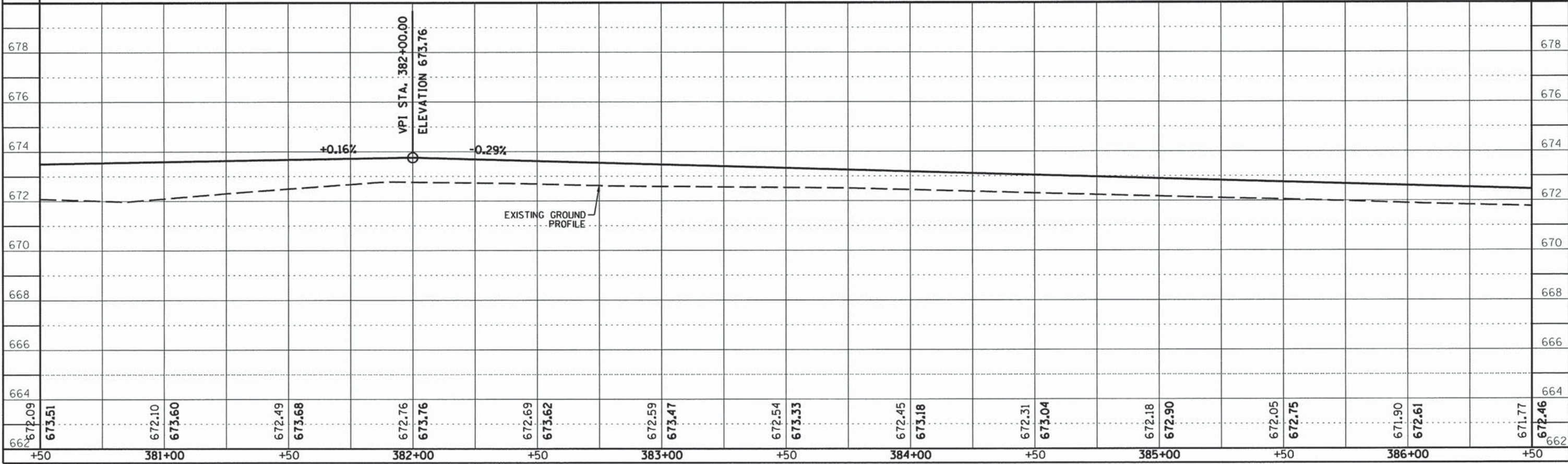
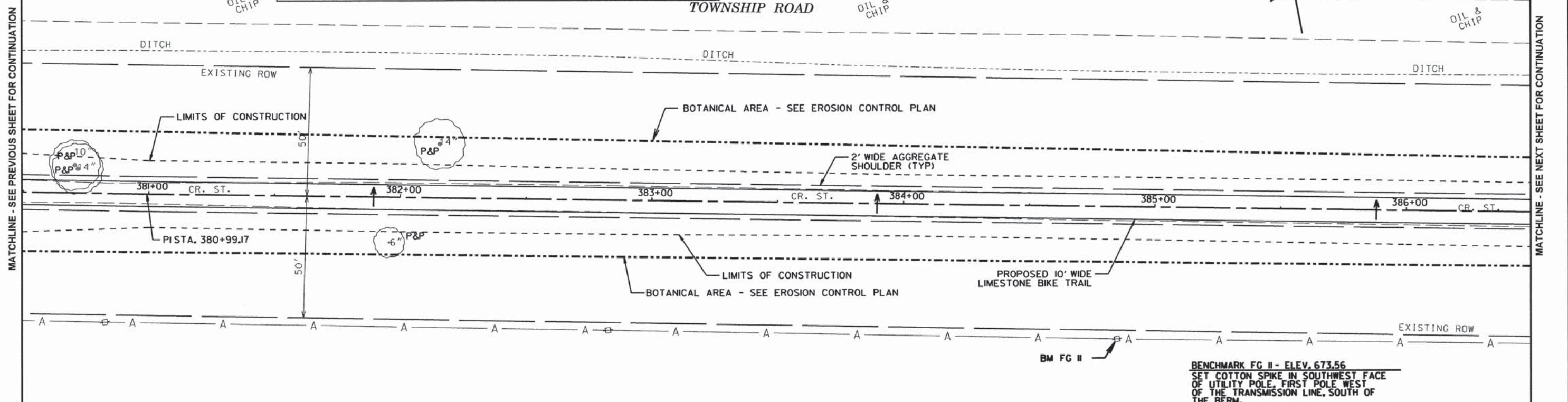

CONTRACT NO. 91520

ROUTE NO.	SECTION	COUNTY	TOTAL SHEETS	SHEET NO.
KICKAPOO TRAIL	08-F3000-02-BT	CHAMPAIGN	262	98
STA.	TO STA.			
F.H.W.A. REG.	ILLINOIS	PROJECT		

**NOTE:**  
 IF ANY TREE OUTSIDE OF THE LIMITS OF CONSTRUCTION THAT ARE ADVERSELY AFFECTED DUE TO CONSTRUCTION ACTIVITIES INCLUDING, BUT NOT LIMITED TO, ROOT DISTURBANCE, BARK REMOVAL, LIMB DAMAGE, THE TREE SHALL BE REMOVED IN ITS ENTIRETY AND HAULED OFF THE SITE AND DISPOSED OFF LEGALLY AT THE CONTRACTOR'S EXPENSE.  
 THE CONTRACTOR SHALL MAKE EVERY EFFORT TO LIMIT HIS OPERATIONS WITHIN THE DESIGNATED LIMITS OF CONSTRUCTION.  
 AT THE OPTION OF THE CCFP, TREES DAMAGED AND REMOVED OUTSIDE OF THE LIMITS OF CONSTRUCTION, THE COST OF REPLACING SAID TREES SHALL BE BORNE BY THE CONTRACTOR.

CURVE 8  
 P.I. STA. 393+62.60  
 Δ = 4°38'59"  
 D = 0°42'50"  
 T = 325.81'  
 R = 8,025.00'  
 L = 651.25'  
 E = 6.61'  
 P.C. STA. 390+36.79  
 P.C.C. STA. 396+88.04

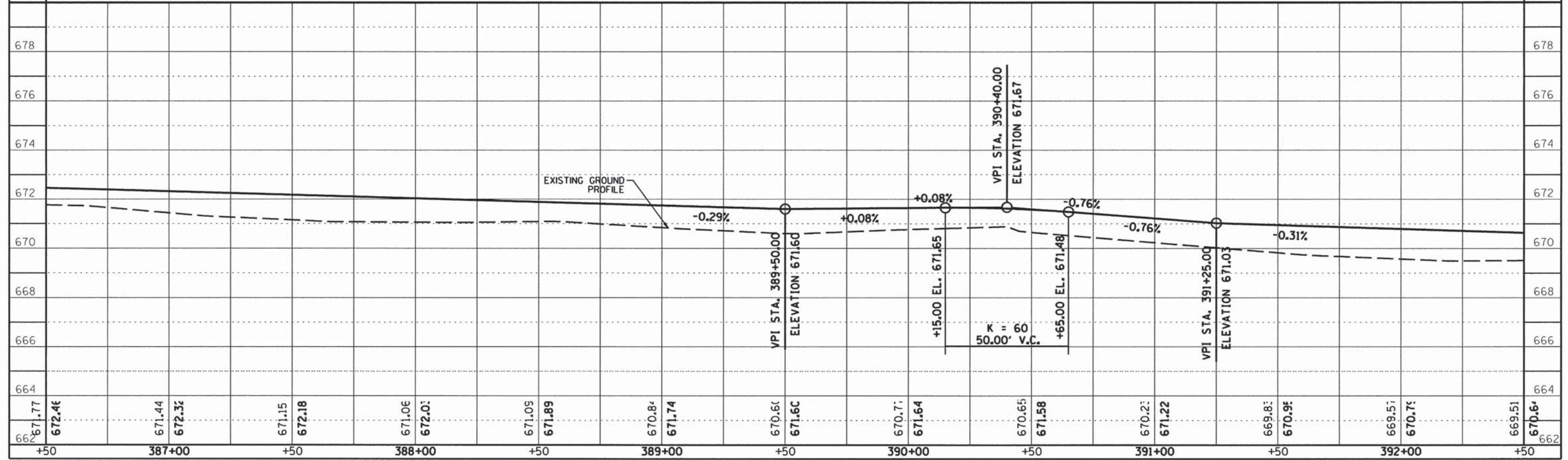
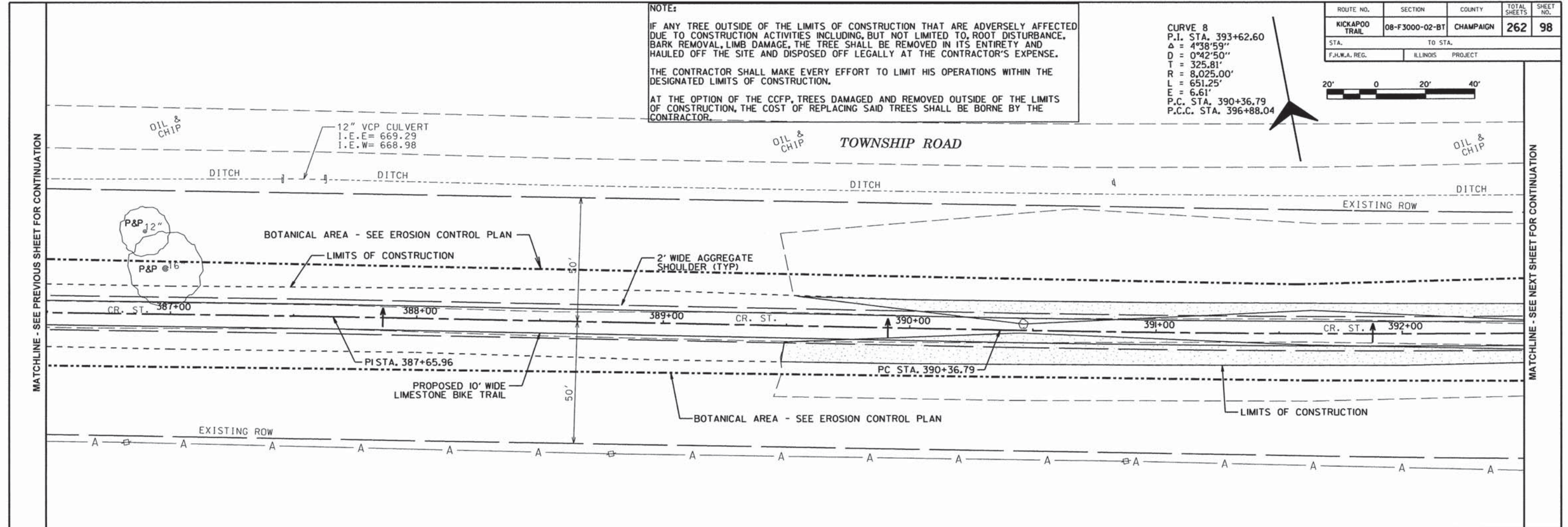

CONTRACT NO. 91520

ROUTE NO.	SECTION	COUNTY	TOTAL SHEETS	SHEET NO.
KICKAPOO TRAIL	08-F3000-02-BT	CHAMPAIGN	262	99
STA.	TO STA.			
F.H.W.A. REG.	ILLINOIS	PROJECT		

**NOTE:**  
 IF ANY TREE OUTSIDE OF THE LIMITS OF CONSTRUCTION THAT ARE ADVERSELY AFFECTED DUE TO CONSTRUCTION ACTIVITIES INCLUDING, BUT NOT LIMITED TO, ROOT DISTURBANCE, BARK REMOVAL, LIMB DAMAGE, THE TREE SHALL BE REMOVED IN ITS ENTIRETY AND HAULED OFF THE SITE AND DISPOSED OFF LEGALLY AT THE CONTRACTOR'S EXPENSE.  
 THE CONTRACTOR SHALL MAKE EVERY EFFORT TO LIMIT HIS OPERATIONS WITHIN THE DESIGNATED LIMITS OF CONSTRUCTION.  
 AT THE OPTION OF THE CCFP, TREES DAMAGED AND REMOVED OUTSIDE OF THE LIMITS OF CONSTRUCTION, THE COST OF REPLACING SAID TREES SHALL BE BORNE BY THE CONTRACTOR.

**CURVE 8**  
 P.I. STA. 393+62.60  
 $\Delta = 4^{\circ}38'59''$   
 $D = 0^{\circ}42'50''$   
 $T = 325.81'$   
 $R = 8,025.00'$   
 $L = 651.25'$   
 $E = 6.61'$   
 P.C. STA. 390+36.79  
 P.C.C. STA. 396+88.04

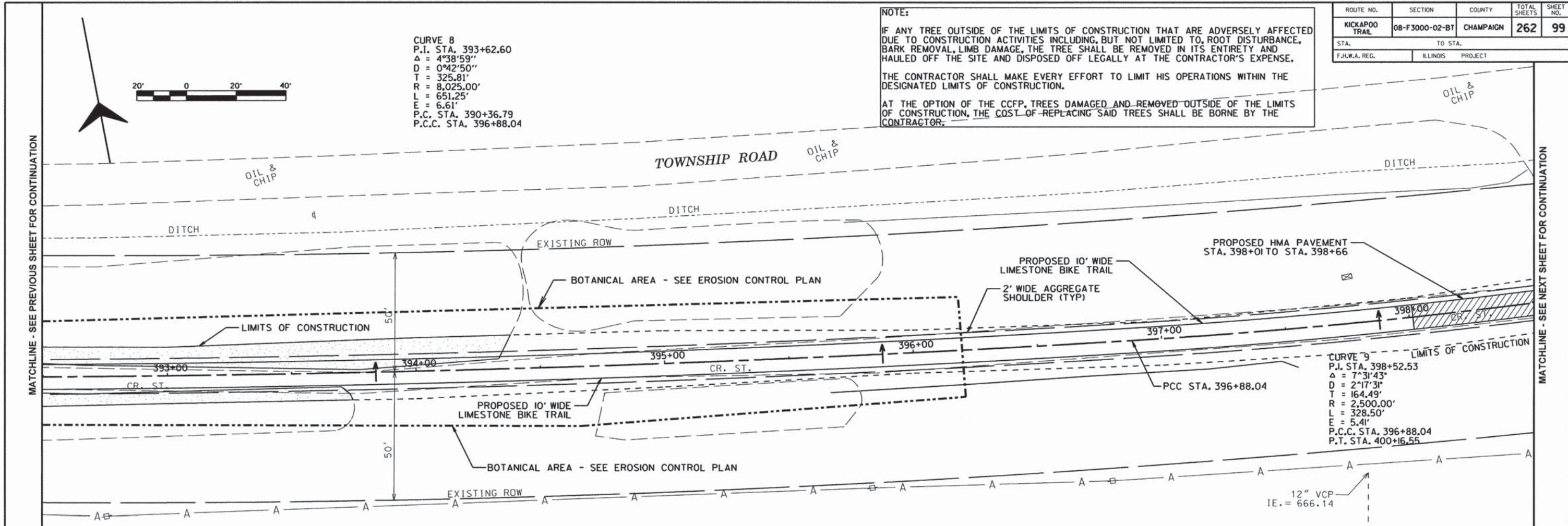

**CURVE 9**  
 P.I. STA. 398+52.53  
 $\Delta = 7^{\circ}31'43''$   
 $D = 2^{\circ}17'31''$   
 $T = 164.49'$   
 $R = 2,500.00'$   
 $L = 328.50'$   
 $E = 5.41'$   
 P.C.C. STA. 396+88.04  
 P.T. STA. 400+16.55

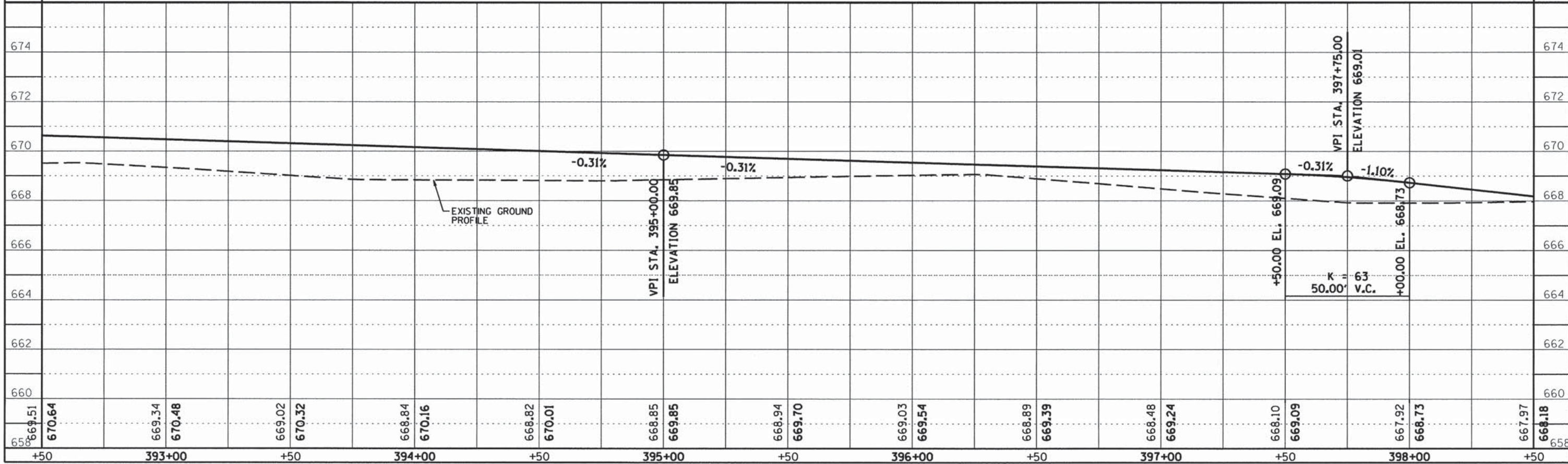

669.51	670.64	669.34	670.48	669.02	670.32	668.84	670.16	668.82	670.01	668.85	669.85	668.94	669.70	669.03	669.54	668.89	669.39	668.48	669.24	668.10	669.09	667.92	668.73	667.97	668.18
+50	393+00	+50	394+00	+50	395+00	+50	396+00	+50	397+00	+50	398+00	+50		+50											



CONTRACT NO. 91520

ROUTE NO.	SECTION	COUNTY	TOTAL SHEETS	SHEET NO.
KICKAPOO TRAIL	08-F3000-02-BT	CHAMPAIGN	262	100
STA.	TO STA.			
F.H.W.A. REG.	ILLINOIS	PROJECT		

**NOTE:**  
 IF ANY TREE OUTSIDE OF THE LIMITS OF CONSTRUCTION THAT ARE ADVERSELY AFFECTED DUE TO CONSTRUCTION ACTIVITIES INCLUDING, BUT NOT LIMITED TO, ROOT DISTURBANCE, BARK REMOVAL, LIMB DAMAGE, THE TREE SHALL BE REMOVED IN ITS ENTIRETY AND HAULED OFF THE SITE AND DISPOSED OFF LEGALLY AT THE CONTRACTOR'S EXPENSE.  
 THE CONTRACTOR SHALL MAKE EVERY EFFORT TO LIMIT HIS OPERATIONS WITHIN THE DESIGNATED LIMITS OF CONSTRUCTION.  
 AT THE OPTION OF THE CCFP, TREES DAMAGED AND REMOVED OUTSIDE OF THE LIMITS OF CONSTRUCTION, THE COST OF REPLACING SAID TREES SHALL BE BORNE BY THE CONTRACTOR.

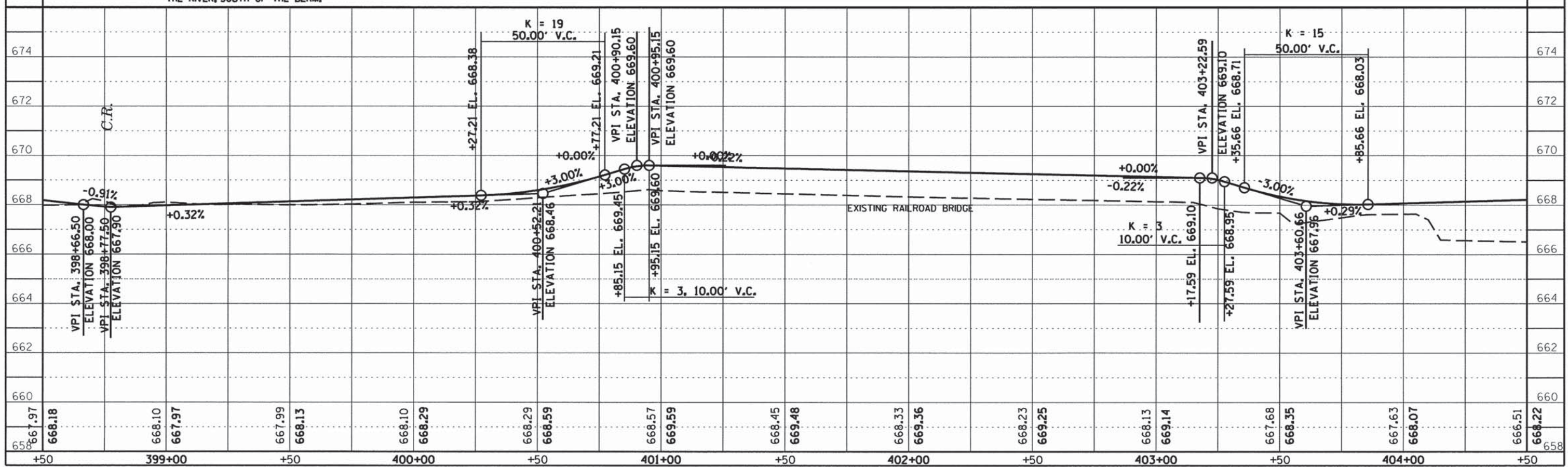
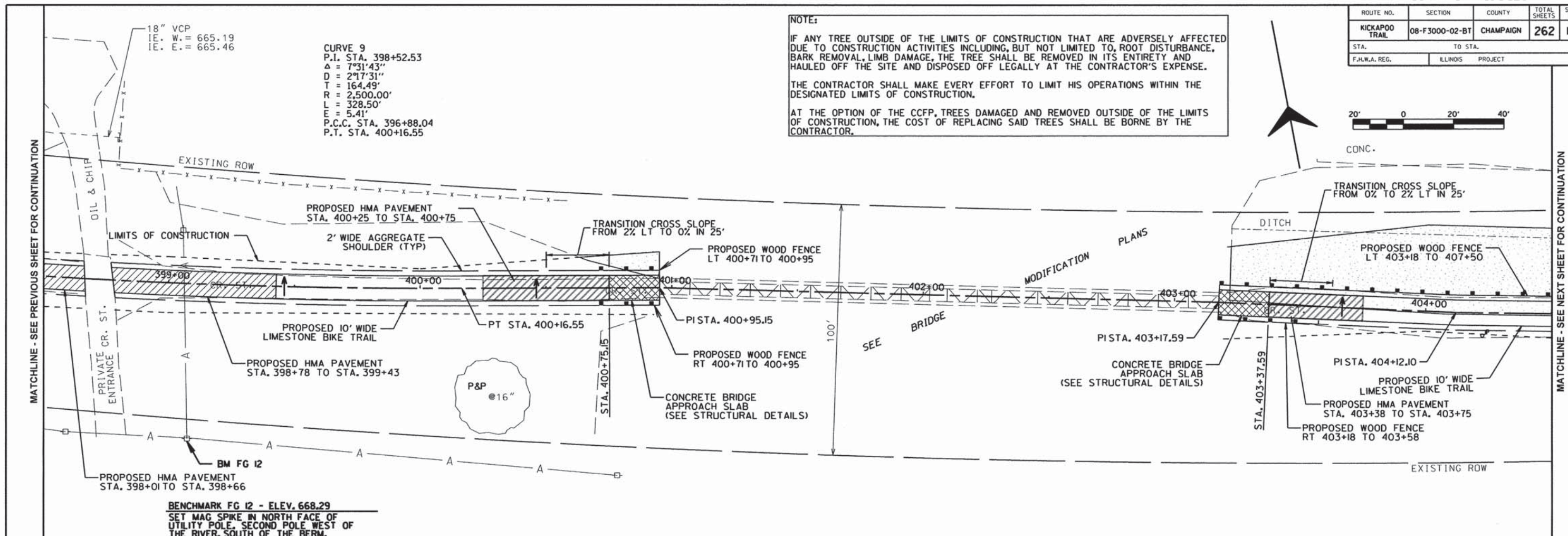

CONTRACT NO. 91520

ROUTE NO.	SECTION	COUNTY	TOTAL SHEETS	SHEET NO.
KICKAPOO TRAIL	08-F3000-02-BT	CHAMPAIGN	262	101
STA.	TO STA.			
F.H.W.A. REG.	ILLINOIS	PROJECT		

# ST. JOSEPH, IL

**CURVE 10**  
 P.I. STA. 407+46.64  
 $\Delta = 6^{\circ}58'21''$   
 $D = 1^{\circ}54'35''$   
 $T = 182.76'$   
 $R = 3,000.00'$   
 $L = 365.07'$   
 $E = 5.56'$   
 P.C. STA. 405+63.88  
 P.C.C. STA. 409+28.95

**CURVE 11**  
 P.I. STA. 412+44.60  
 $\Delta = 6^{\circ}01'22''$   
 $D = 0^{\circ}57'18''$   
 $T = 315.65'$   
 $R = 6,000.00'$   
 $L = 630.71'$   
 $E = 8.30'$   
 P.C.C. STA. 409+28.95  
 P.T. STA. 415+59.66



MATCHLINE - SEE PREVIOUS SHEET FOR CONTINUATION

MATCHLINE - SEE NEXT SHEET FOR CONTINUATION

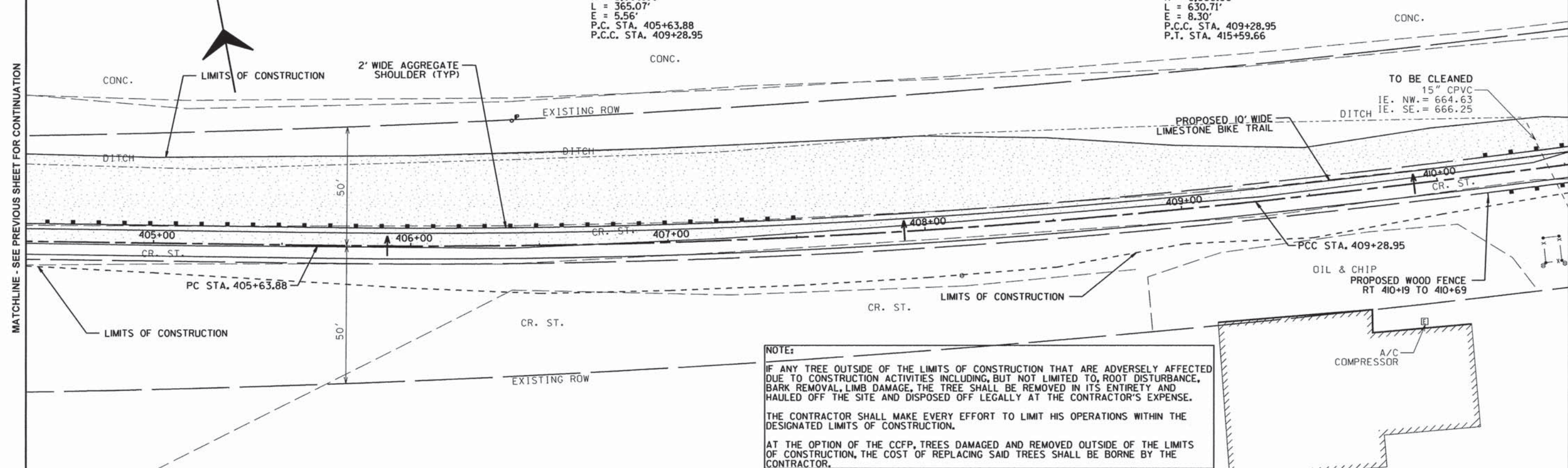

**NOTE:**  
 IF ANY TREE OUTSIDE OF THE LIMITS OF CONSTRUCTION THAT ARE ADVERSELY AFFECTED DUE TO CONSTRUCTION ACTIVITIES INCLUDING, BUT NOT LIMITED TO, ROOT DISTURBANCE, BARK REMOVAL, LIMB DAMAGE, THE TREE SHALL BE REMOVED IN ITS ENTIRETY AND HAULED OFF THE SITE AND DISPOSED OFF LEGALLY AT THE CONTRACTOR'S EXPENSE.  
 THE CONTRACTOR SHALL MAKE EVERY EFFORT TO LIMIT HIS OPERATIONS WITHIN THE DESIGNATED LIMITS OF CONSTRUCTION.  
 AT THE OPTION OF THE CCFP, TREES DAMAGED AND REMOVED OUTSIDE OF THE LIMITS OF CONSTRUCTION, THE COST OF REPLACING SAID TREES SHALL BE BORNE BY THE CONTRACTOR.

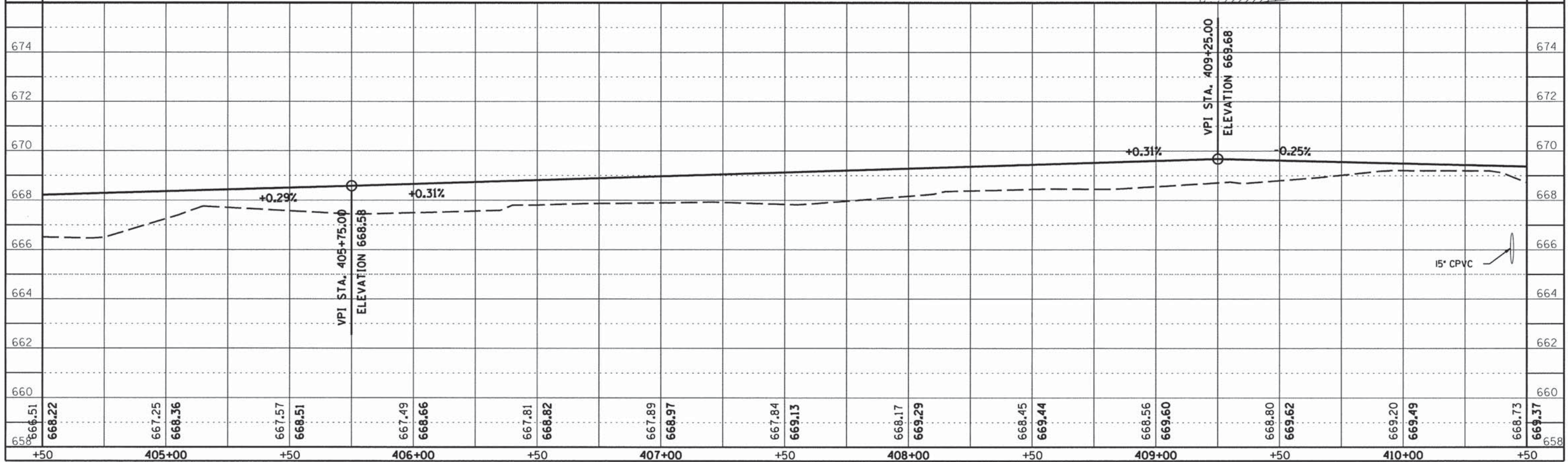

CONTRACT NO. 91520

ROUTE NO.	SECTION	COUNTY	TOTAL SHEETS	SHEET NO.
KICKAPOO TRAIL	08-F3000-02-BT	CHAMPAIGN	262	102
STA.	TO STA.			
F.H.W.A. REG.	ILLINOIS PROJECT			



**NOTE:**  
 IF ANY TREE OUTSIDE OF THE LIMITS OF CONSTRUCTION THAT ARE ADVERSELY AFFECTED DUE TO CONSTRUCTION ACTIVITIES INCLUDING, BUT NOT LIMITED TO, ROOT DISTURBANCE, BARK REMOVAL, LIMB DAMAGE, THE TREE SHALL BE REMOVED IN ITS ENTIRETY AND HAULED OFF THE SITE AND DISPOSED OFF LEGALLY AT THE CONTRACTOR'S EXPENSE.  
 THE CONTRACTOR SHALL MAKE EVERY EFFORT TO LIMIT HIS OPERATIONS WITHIN THE DESIGNATED LIMITS OF CONSTRUCTION.  
 AT THE OPTION OF THE CCFP, TREES DAMAGED AND REMOVED OUTSIDE OF THE LIMITS OF CONSTRUCTION, THE COST OF REPLACING SAID TREES SHALL BE BORNE BY THE CONTRACTOR.

ST. JOSEPH, IL

**CURVE 11**  
 P.I. STA. 412+44.60  
 $\Delta = 6^{\circ}01'22''$   
 $D = 0^{\circ}57'18''$   
 $T = 315.65'$   
 $R = 6,000.00'$   
 $L = 630.71'$   
 $E = 8.30'$   
 P.C.C. STA. 409+28.95  
 P.T. STA. 415+59.66

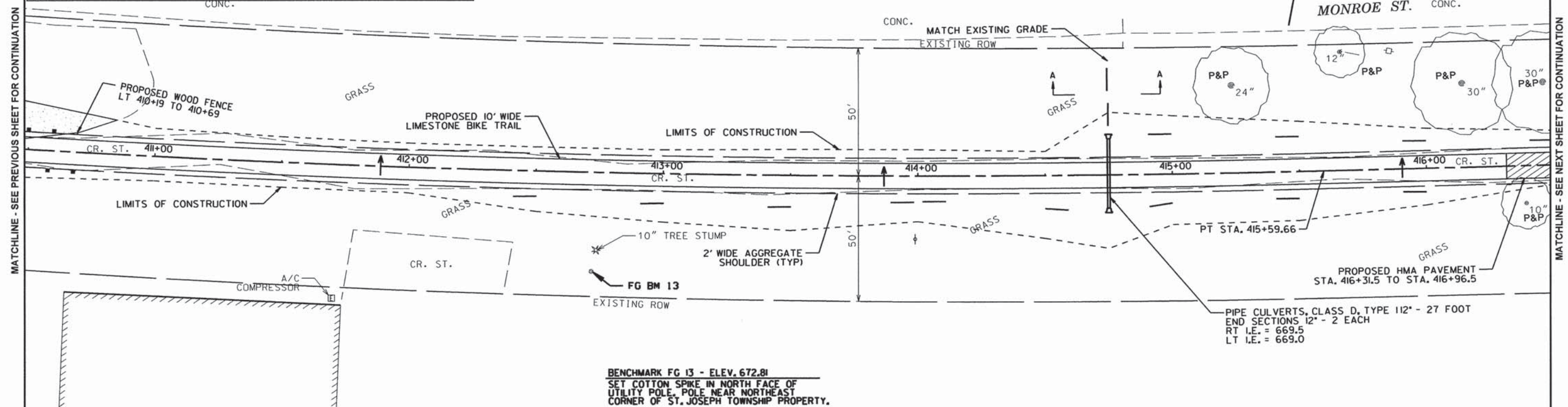

**BENCHMARK FG 13 - ELEV. 672.81**  
 SET COTTON SPIKE IN NORTH FACE OF UTILITY POLE, POLE NEAR NORTHEAST CORNER OF ST. JOSEPH TOWNSHIP PROPERTY.

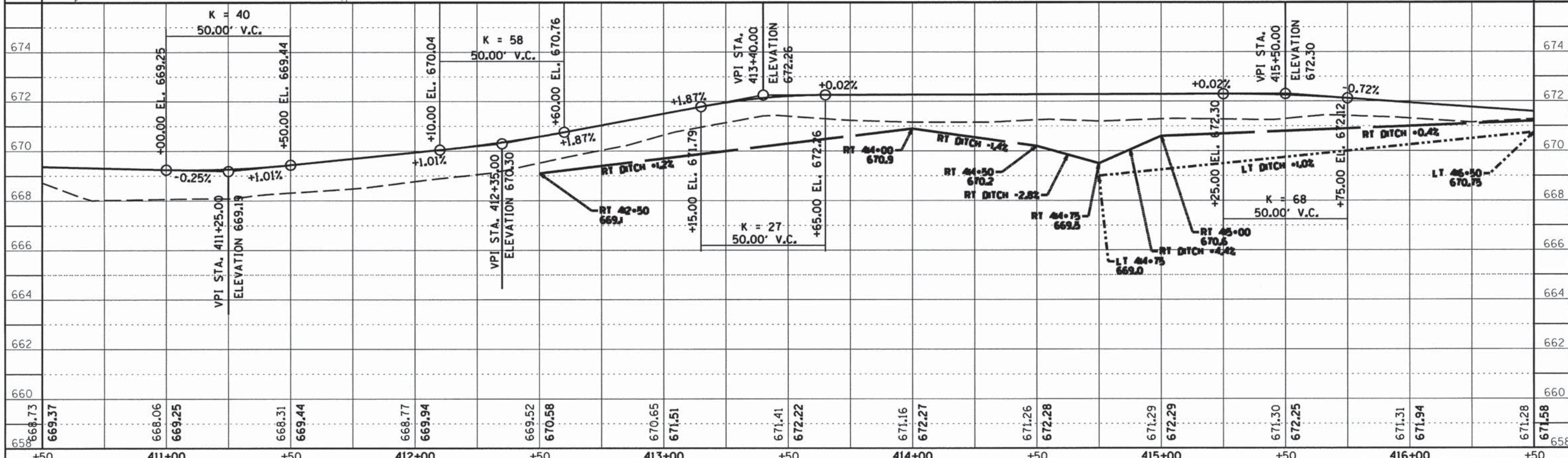

CONTRACT NO. 91520

ROUTE NO.	SECTION	COUNTY	TOTAL SHEETS	SHEET NO.
KICKAPOO TRAIL	08-F3000-02-BT	CHAMPAIGN	262	103
STA.	TO STA.			
F.H.W.A. REG.	ILLINOIS PROJECT			

ST. JOSEPH, IL

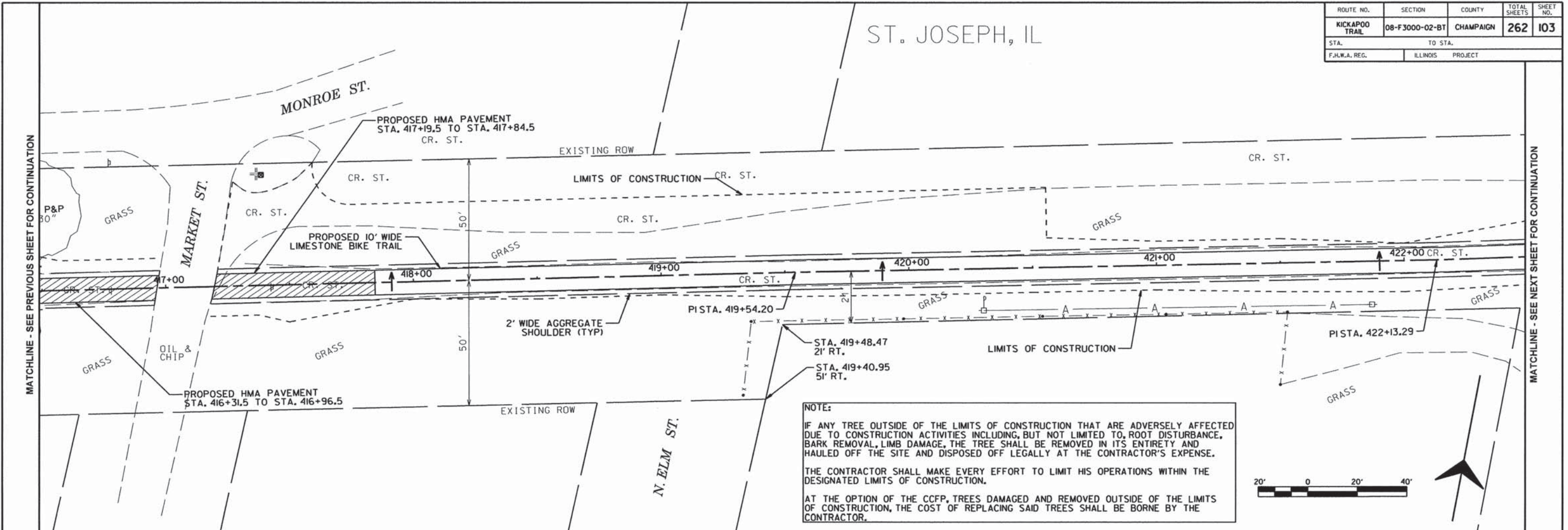

**NOTE:**  
 IF ANY TREE OUTSIDE OF THE LIMITS OF CONSTRUCTION THAT ARE ADVERSELY AFFECTED DUE TO CONSTRUCTION ACTIVITIES INCLUDING, BUT NOT LIMITED TO, ROOT DISTURBANCE, BARK REMOVAL, LIMB DAMAGE, THE TREE SHALL BE REMOVED IN ITS ENTIRETY AND HAULED OFF THE SITE AND DISPOSED OFF LEGALLY AT THE CONTRACTOR'S EXPENSE.  
 THE CONTRACTOR SHALL MAKE EVERY EFFORT TO LIMIT HIS OPERATIONS WITHIN THE DESIGNATED LIMITS OF CONSTRUCTION.  
 AT THE OPTION OF THE CCFP, TREES DAMAGED AND REMOVED OUTSIDE OF THE LIMITS OF CONSTRUCTION, THE COST OF REPLACING SAID TREES SHALL BE BORNE BY THE CONTRACTOR.

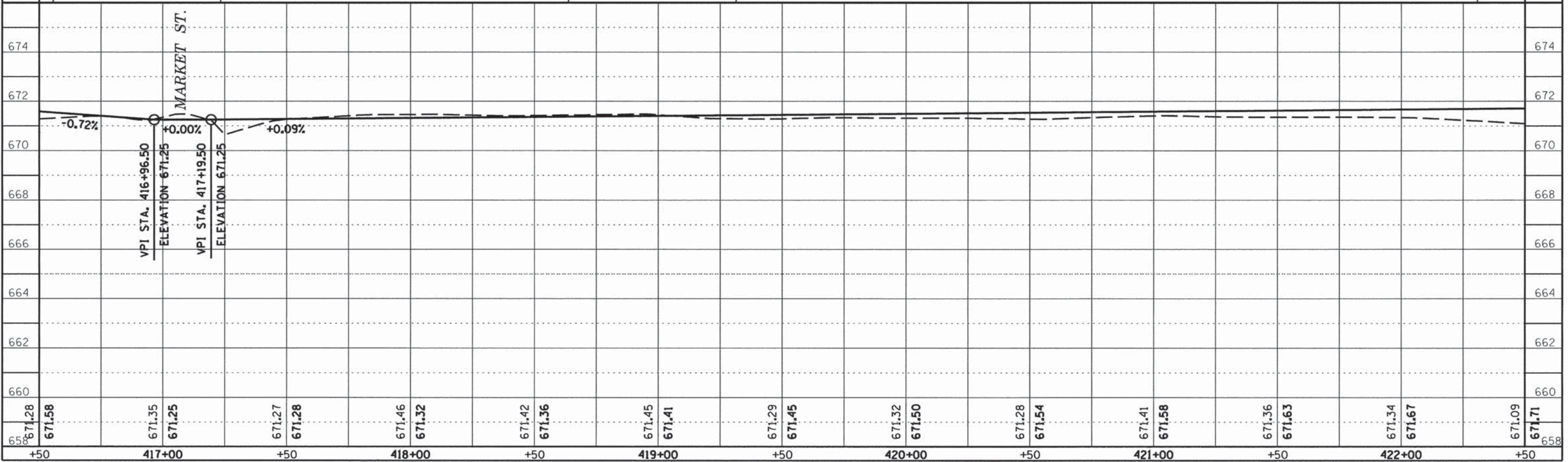

CONTRACT NO. 91520

ROUTE NO.	SECTION	COUNTY	TOTAL SHEETS	SHEET NO.
KICKAPOO TRAIL	08-F3000-02-BT	CHAMPAIGN	262	104
STA.	TO STA.			
F.H.W.A. REG.	ILLINOIS PROJECT			

ST. JOSEPH, IL

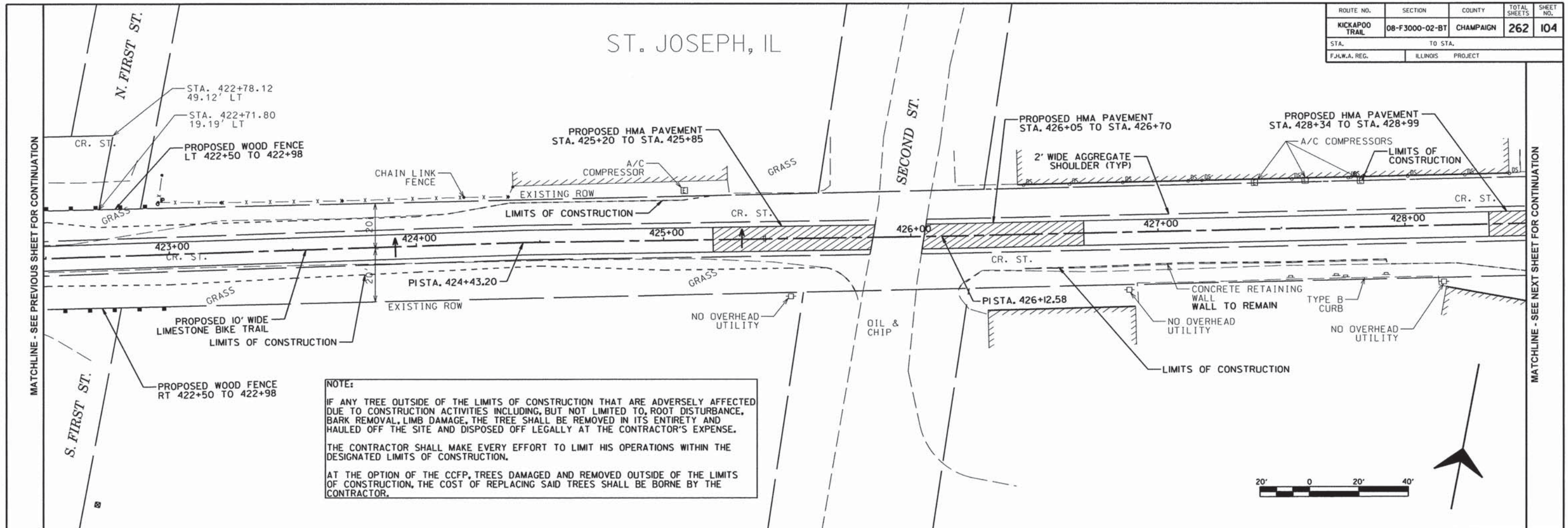

**NOTE:**  
 IF ANY TREE OUTSIDE OF THE LIMITS OF CONSTRUCTION THAT ARE ADVERSELY AFFECTED DUE TO CONSTRUCTION ACTIVITIES INCLUDING, BUT NOT LIMITED TO, ROOT DISTURBANCE, BARK REMOVAL, LIMB DAMAGE, THE TREE SHALL BE REMOVED IN ITS ENTIRETY AND HAULED OFF THE SITE AND DISPOSED OFF LEGALLY AT THE CONTRACTOR'S EXPENSE.  
 THE CONTRACTOR SHALL MAKE EVERY EFFORT TO LIMIT HIS OPERATIONS WITHIN THE DESIGNATED LIMITS OF CONSTRUCTION.  
 AT THE OPTION OF THE CCFP, TREES DAMAGED AND REMOVED OUTSIDE OF THE LIMITS OF CONSTRUCTION, THE COST OF REPLACING SAID TREES SHALL BE BORNE BY THE CONTRACTOR.

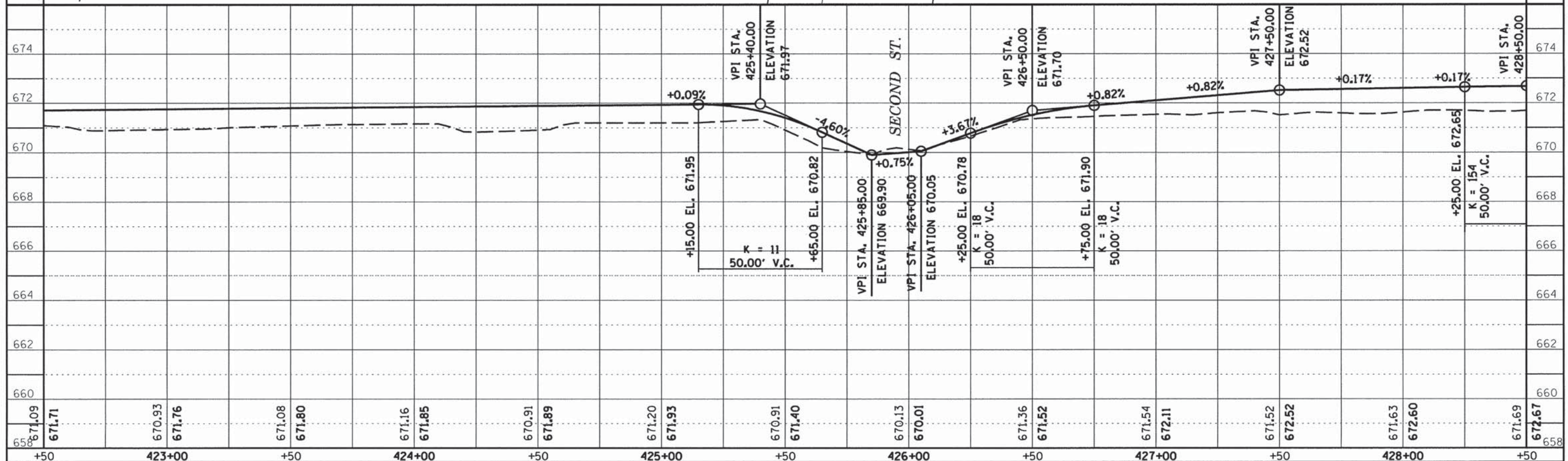

CONTRACT NO. 91520

ROUTE NO.	SECTION	COUNTY	TOTAL SHEETS	SHEET NO.
KICKAPOO TRAIL	08-F3000-02-BT	CHAMPAIGN	262	105
STA.		TO STA.		
F.H.W.A. REG.		ILLINOIS PROJECT		

ST. JOSEPH, IL

**NOTE:**  
 IF ANY TREE OUTSIDE OF THE LIMITS OF CONSTRUCTION THAT ARE ADVERSELY AFFECTED DUE TO CONSTRUCTION ACTIVITIES INCLUDING, BUT NOT LIMITED TO, ROOT DISTURBANCE, BARK REMOVAL, LIMB DAMAGE, THE TREE SHALL BE REMOVED IN ITS ENTIRETY AND HAULED OFF THE SITE AND DISPOSED OFF LEGALLY AT THE CONTRACTOR'S EXPENSE.  
 THE CONTRACTOR SHALL MAKE EVERY EFFORT TO LIMIT HIS OPERATIONS WITHIN THE DESIGNATED LIMITS OF CONSTRUCTION.  
 AT THE OPTION OF THE CCFP, TREES DAMAGED AND REMOVED OUTSIDE OF THE LIMITS OF CONSTRUCTION, THE COST OF REPLACING SAID TREES SHALL BE BORNE BY THE CONTRACTOR.

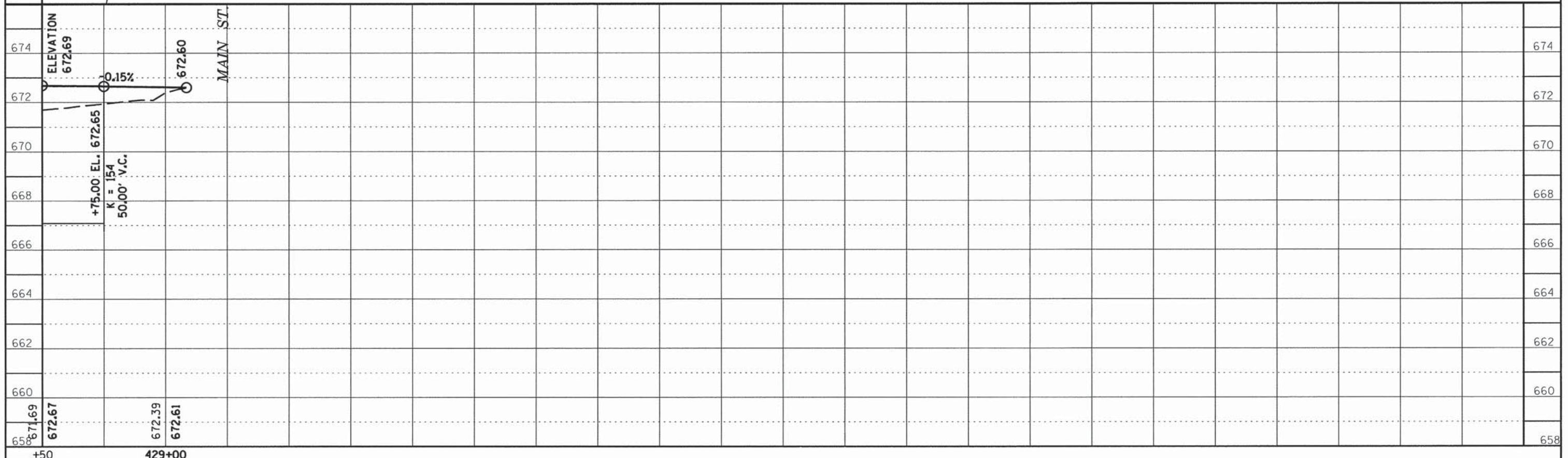
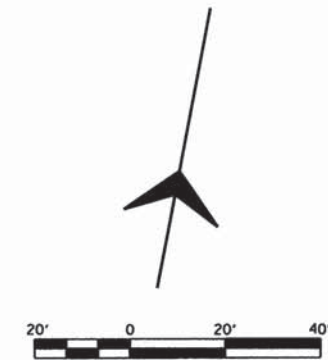
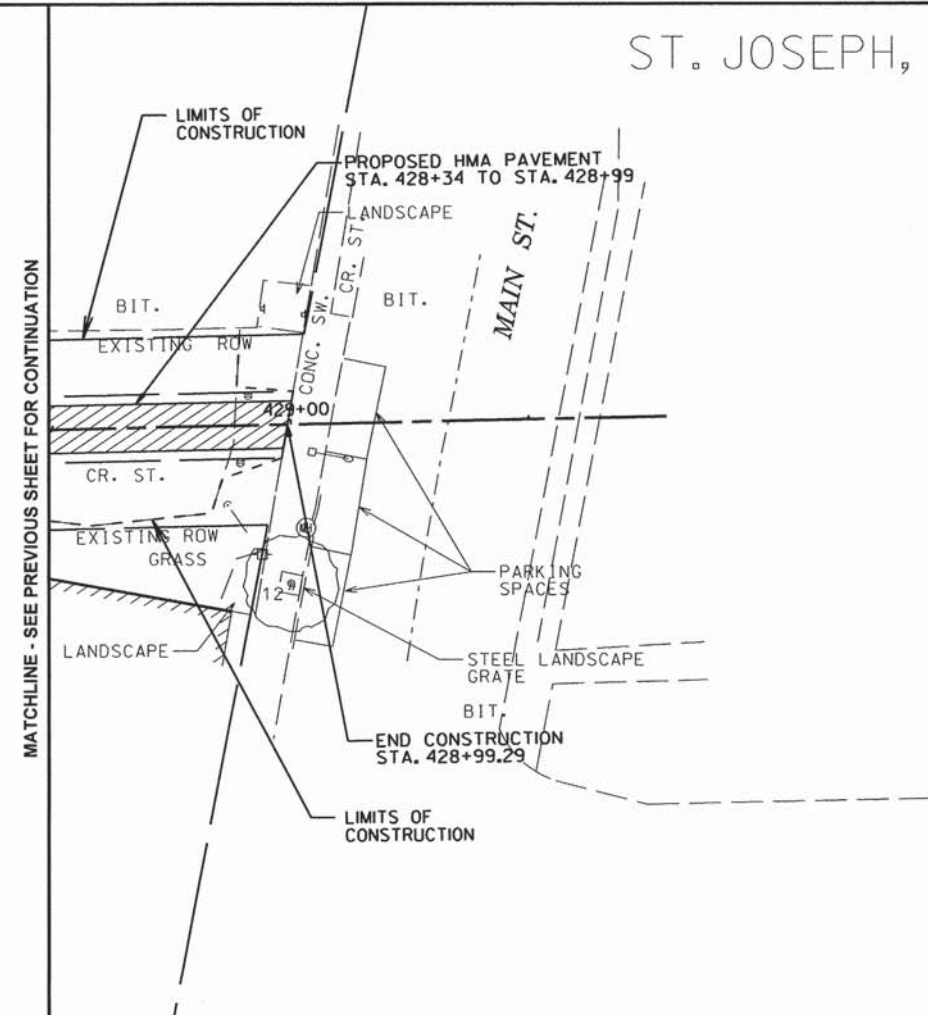

Attachment F:

**Kickapoo Rail Trail Phase 1**  
**Construction Cross Section Drawings**  
**Sheets 157-262**

CONTRACT NO. 91520

ROUTE NO.	SECTION	COUNTY	TOTAL SHEETS	SHEET NO.
KICKAPOO TRAIL	DB-F3000-02-BT	CHAMPAIGN	262	157
STA.		TO STA.		45
F.H.W.A. REG.		ILLINOIS PROJECT		

DATE	
BY	
DESIGNED	
CHECKED	
DATE	
BY	
DESIGNED	
CHECKED	
DATE	
BY	
DESIGNED	
CHECKED	

DATE	
BY	
DESIGNED	
CHECKED	
DATE	
BY	
DESIGNED	
CHECKED	
DATE	
BY	
DESIGNED	
CHECKED	

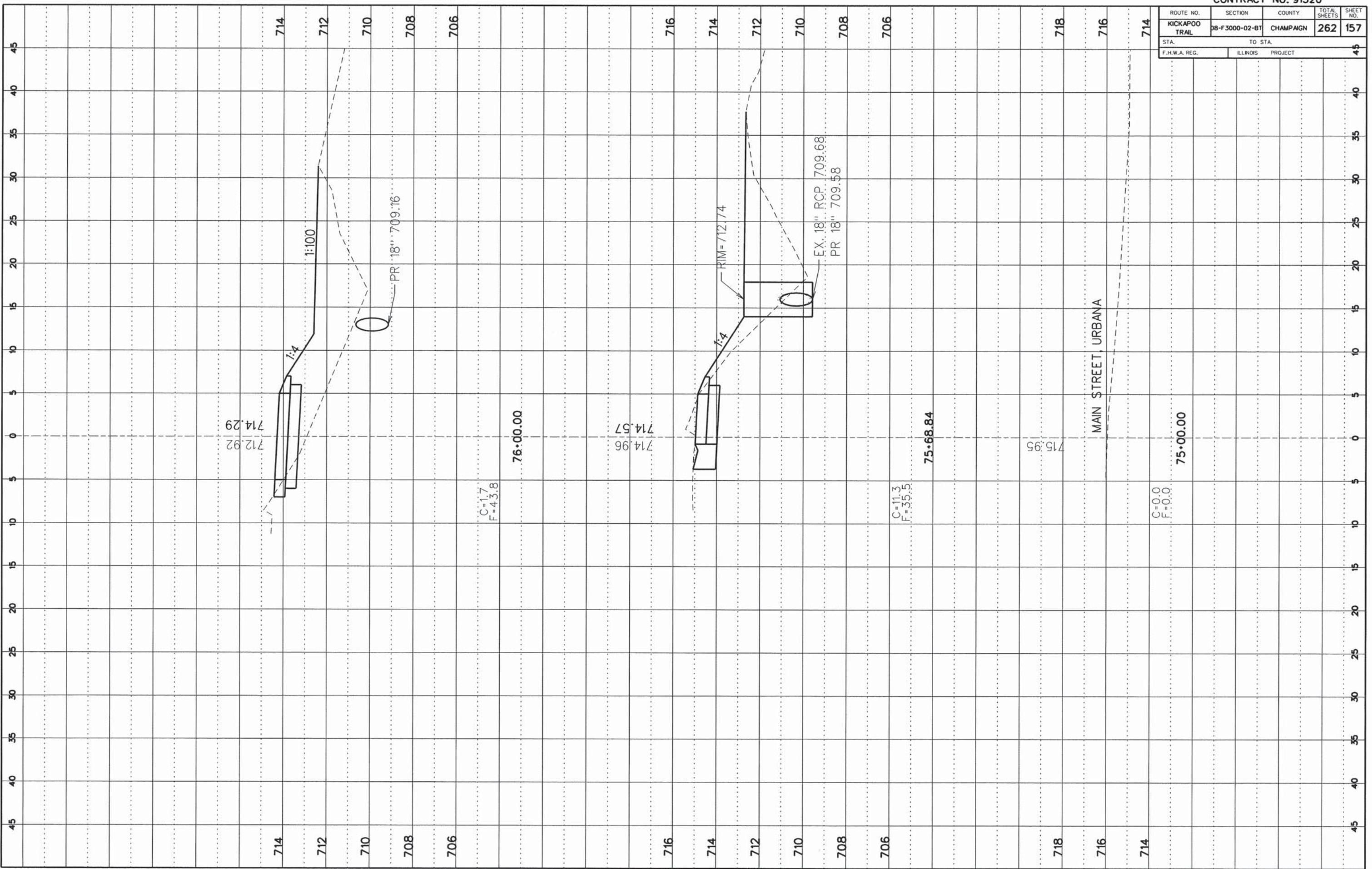

CCFPD KICKAPOO BIKE TRAIL CHAMPAIGN COUNTY

SHEET 157 OF 262 SHEETS 08074



CONTRACT NO. 91520

ROUTE NO.	SECTION	COUNTY	TOTAL SHEETS	SHEET NO.
KICKAPOO TRAIL	DB-F3000-02-BT	CHAMPAIGN	262	158
STA. TO STA.		F.H.W.A. REG. ILLINOIS PROJECT		
		45 45		

FINAL SURVEY  
 NO. \_\_\_\_\_  
 DATE \_\_\_\_\_

ORIGINAL SURVEY  
 NO. \_\_\_\_\_  
 DATE \_\_\_\_\_

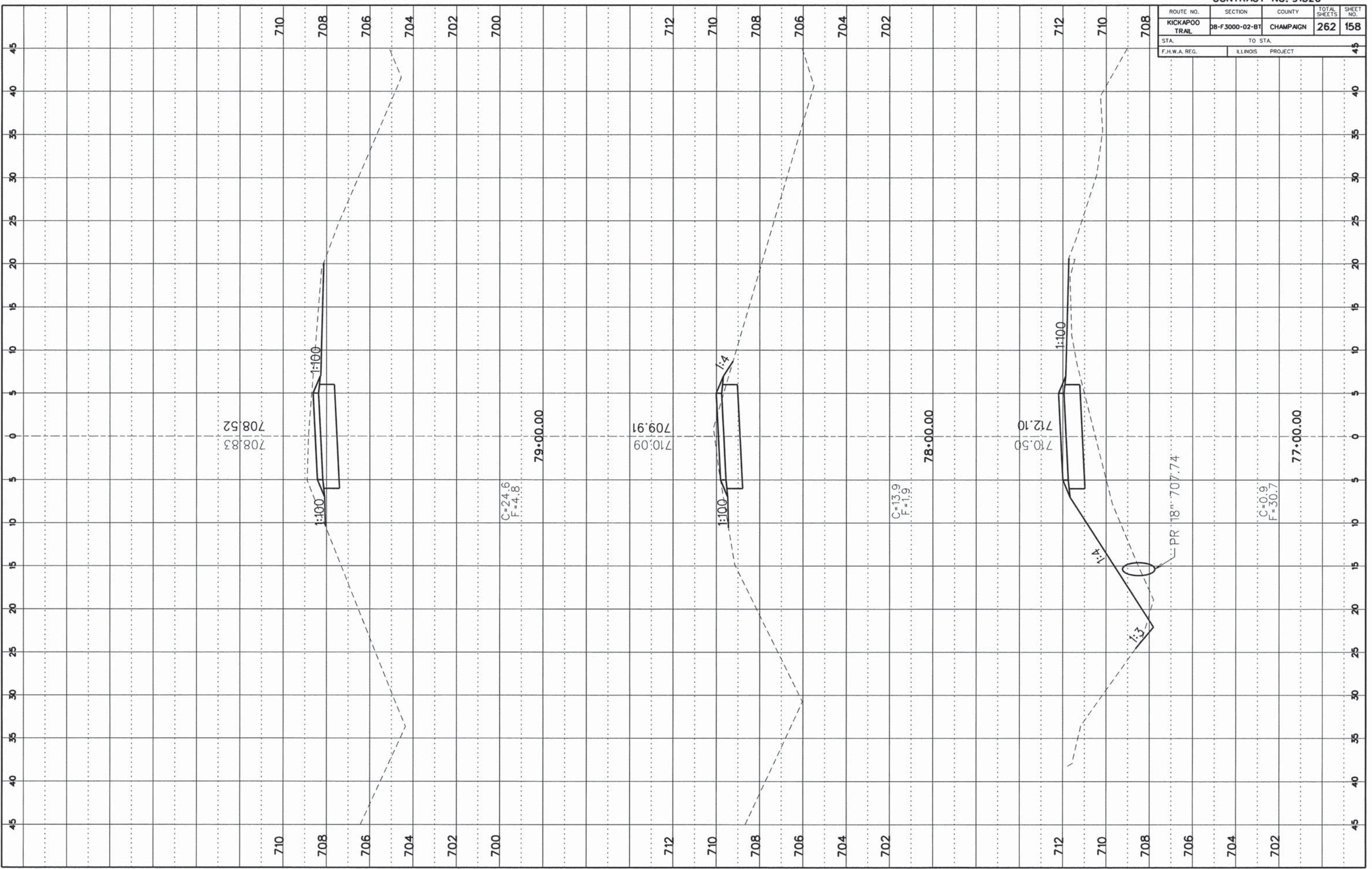

708.83  
708.52

C=24.6  
F=4.8  
79+00.00

710.09  
709.91

C=13.9  
F=1.9  
78+00.00

710.50  
712.10

PR 18" 707.74

C=0.9  
F=30.7  
77+00.00

CONTRACT NO. 91520

ROUTE NO.	SECTION	COUNTY	TOTAL SHEETS	SHEET NO.
KICKAPOO TRAIL	DB-F 3000-02-BT	CHAMPAIGN	262	159
STA. F.H.W.A. REG.		TO STA. ILLINOIS PROJECT		45

FINAL SURVEY  
 DRAWN BY: \_\_\_\_\_  
 CHECKED BY: \_\_\_\_\_  
 DATE: \_\_\_\_\_  
 NOTE BOOK NO.: \_\_\_\_\_  
 AREA: \_\_\_\_\_  
 AREA DEGREE: \_\_\_\_\_

ORIGINAL SURVEY  
 DRAWN BY: \_\_\_\_\_  
 CHECKED BY: \_\_\_\_\_  
 DATE: \_\_\_\_\_  
 NOTE BOOK NO.: \_\_\_\_\_  
 AREA: \_\_\_\_\_  
 AREA DEGREE: \_\_\_\_\_

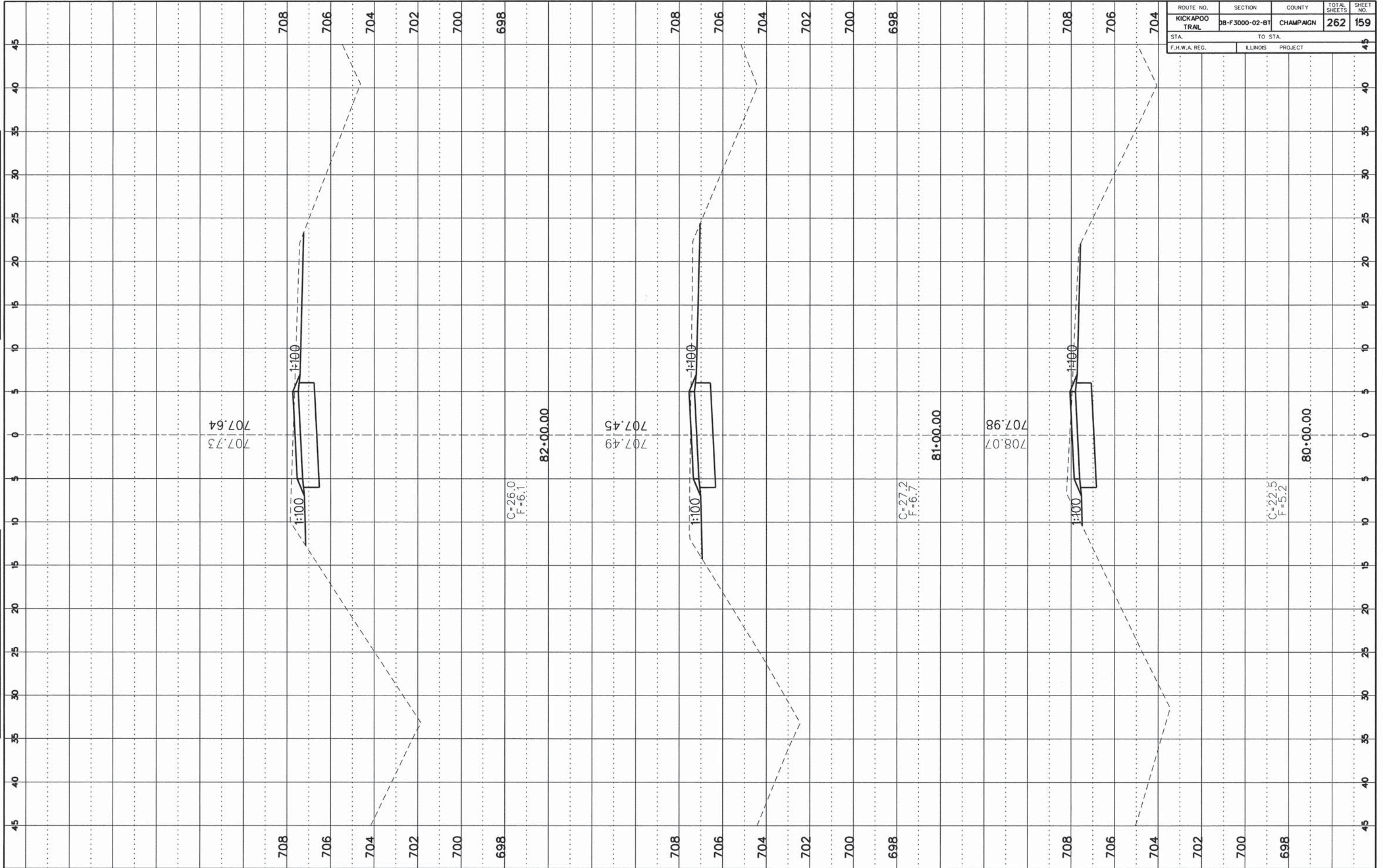

707.73  
707.64

C=26.0  
F=6.1

82+00.00

707.49  
707.45

C=27.2  
F=6.7

81+00.00

708.07  
707.98

C=22.5  
F=5.2

80+00.00

CONTRACT NO. 91520

ROUTE NO.	SECTION	COUNTY	TOTAL SHEETS	SHEET NO.
KICKAPOO TRAIL	DB-F3000-02-BT	CHAMPAIGN	262	160
STA. _____		TO STA. _____		45
F.H.W.A. REG. _____		ILLINOIS PROJECT _____		45

FINAL SURVEY  
 NO. \_\_\_\_\_  
 DATE \_\_\_\_\_

ORIGINAL SURVEY  
 NO. \_\_\_\_\_  
 DATE \_\_\_\_\_

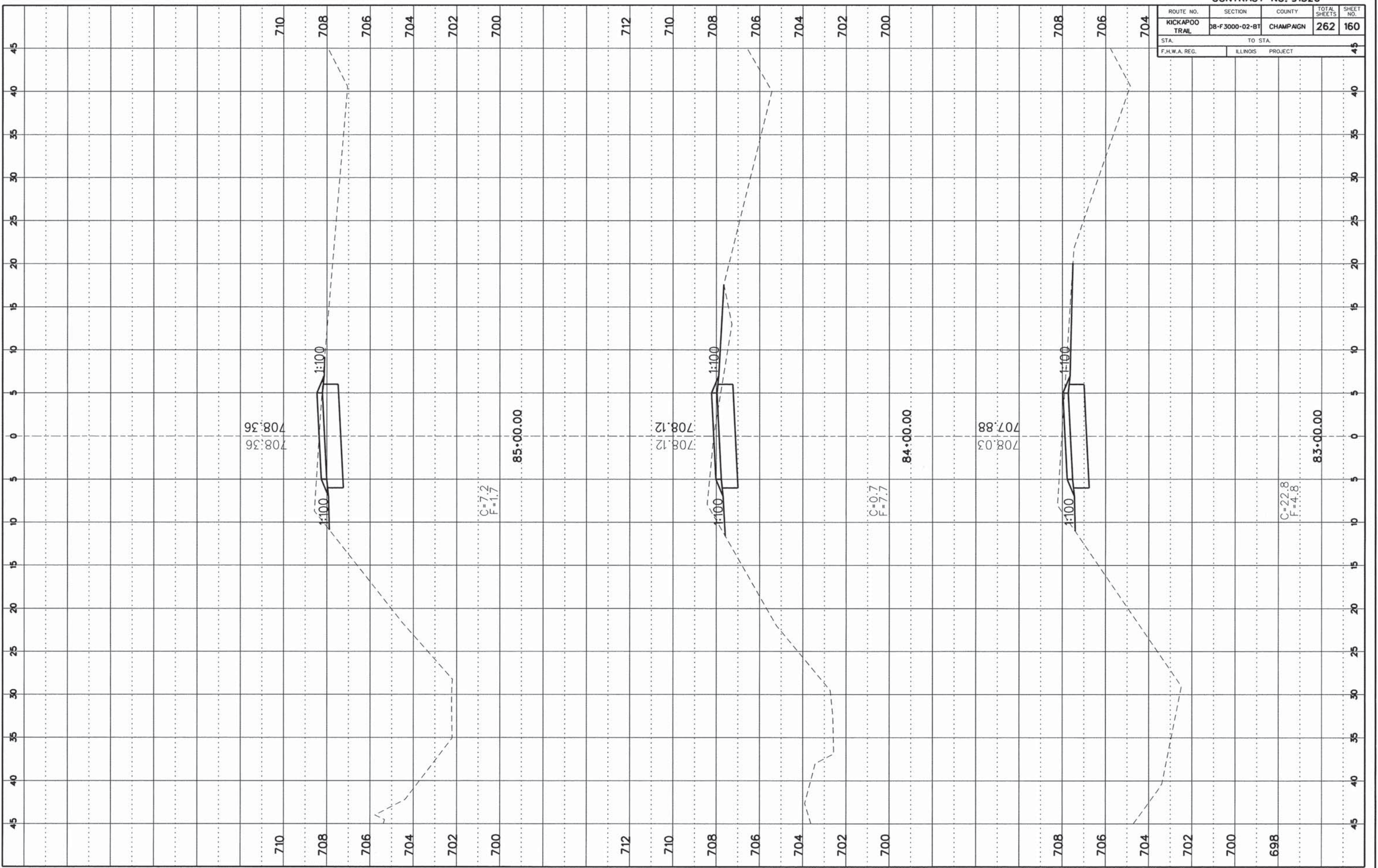

CONTRACT NO. 91520

ROUTE NO.	SECTION	COUNTY	TOTAL SHEETS	SHEET NO.
KICKAPOO TRAIL	08-F3000-02-BT	CHAMPAIGN	262	161
STA.	TO STA.			
F.H.W.A. REG.	ILLINOIS	PROJECT		45

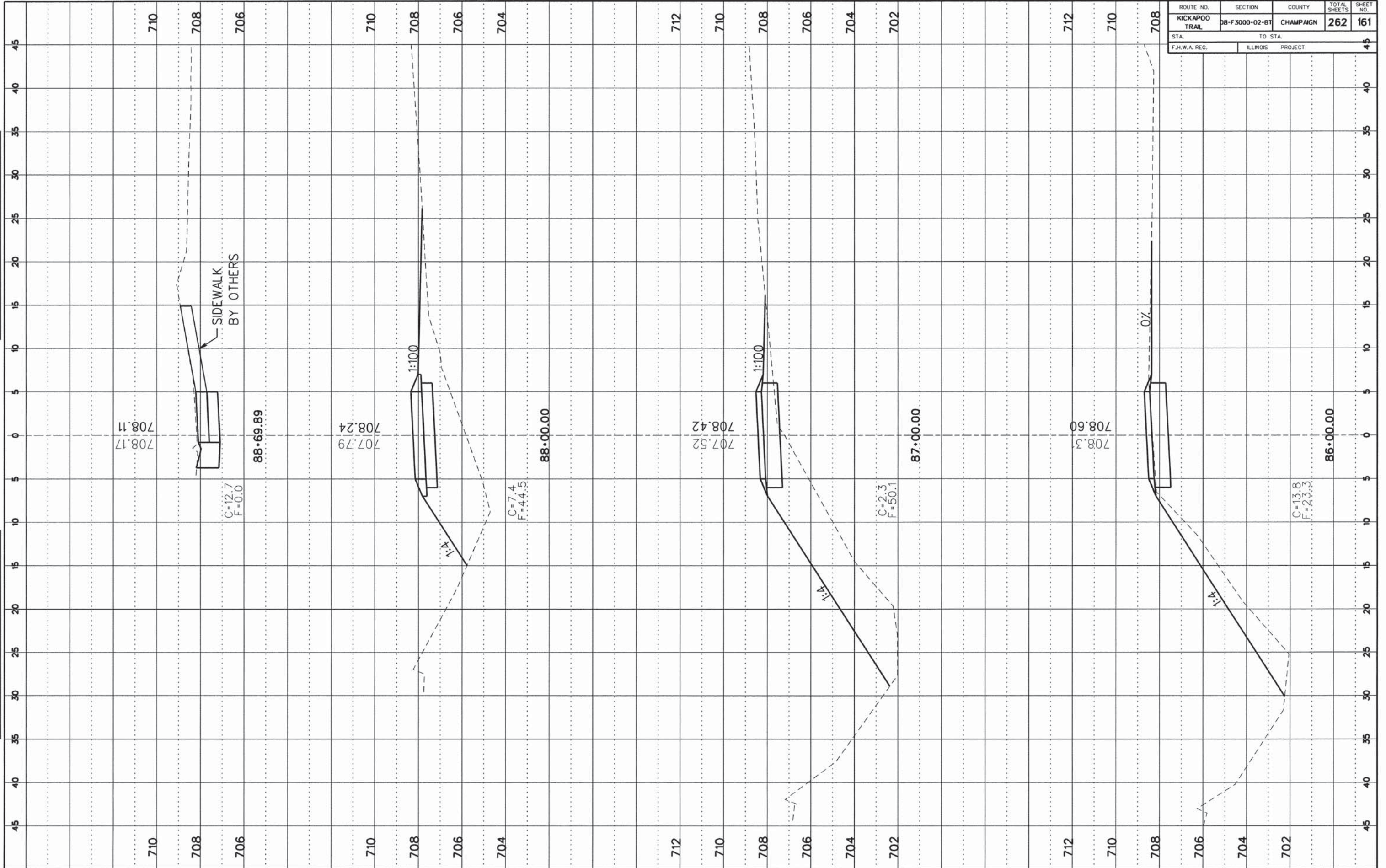

BY	DATE

FINAL SURVEY  
 SHEETS PLOTTED  
 NOTE BOOK NO. \_\_\_\_\_  
 AREA DEPT. \_\_\_\_\_

BY	DATE

ORIGINAL SURVEY  
 SHEETS PLOTTED  
 NOTE BOOK NO. \_\_\_\_\_  
 AREA DEPT. \_\_\_\_\_

CONTRACT NO. 91520

ROUTE NO.	SECTION	COUNTY	TOTAL SHEETS	SHEET NO.
KICKAPOO TRAIL	08-F3000-02-BT	CHAMPAIGN	262	162
STA.		TO STA.		
F.H.W.A. REG.		ILLINOIS PROJECT		

FINAL SURVEY		DATE
SURVEYED	PLOTTED	
NOTE BOOK NO.	AREA CHECKED	

ORIGINAL SURVEY		DATE
SURVEYED	PLOTTED	
NOTE BOOK NO.	AREA CHECKED	

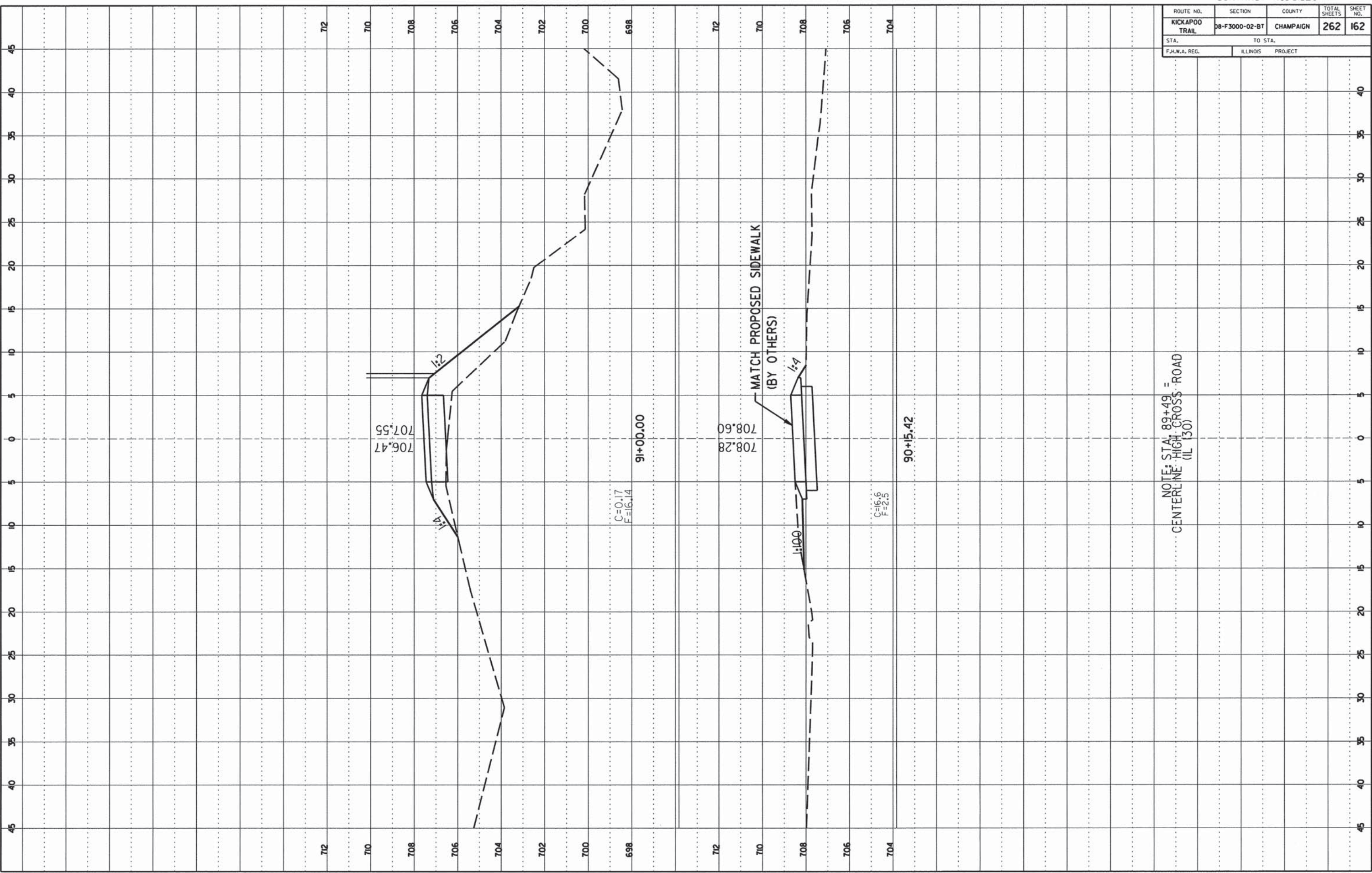

CCFPD KICKAPOO BIKE TRAIL CHAMPAIGN COUNTY

CONTRACT NO. 91520

ROUTE NO.	SECTION	COUNTY	TOTAL SHEETS	SHEET NO.
KICKAPOO TRAIL	08-F3000-02-BT	CHAMPAIGN	262	163
STA. _____ TO STA. _____		ILLINOIS PROJECT		
F.H.W.A. REG. _____		PROJECT _____		

FINAL SURVEY  
 DATE: \_\_\_\_\_  
 BY: \_\_\_\_\_  
 CHECKED: \_\_\_\_\_  
 NO. \_\_\_\_\_

ORIGINAL SURVEY  
 DATE: \_\_\_\_\_  
 BY: \_\_\_\_\_  
 CHECKED: \_\_\_\_\_  
 NO. \_\_\_\_\_

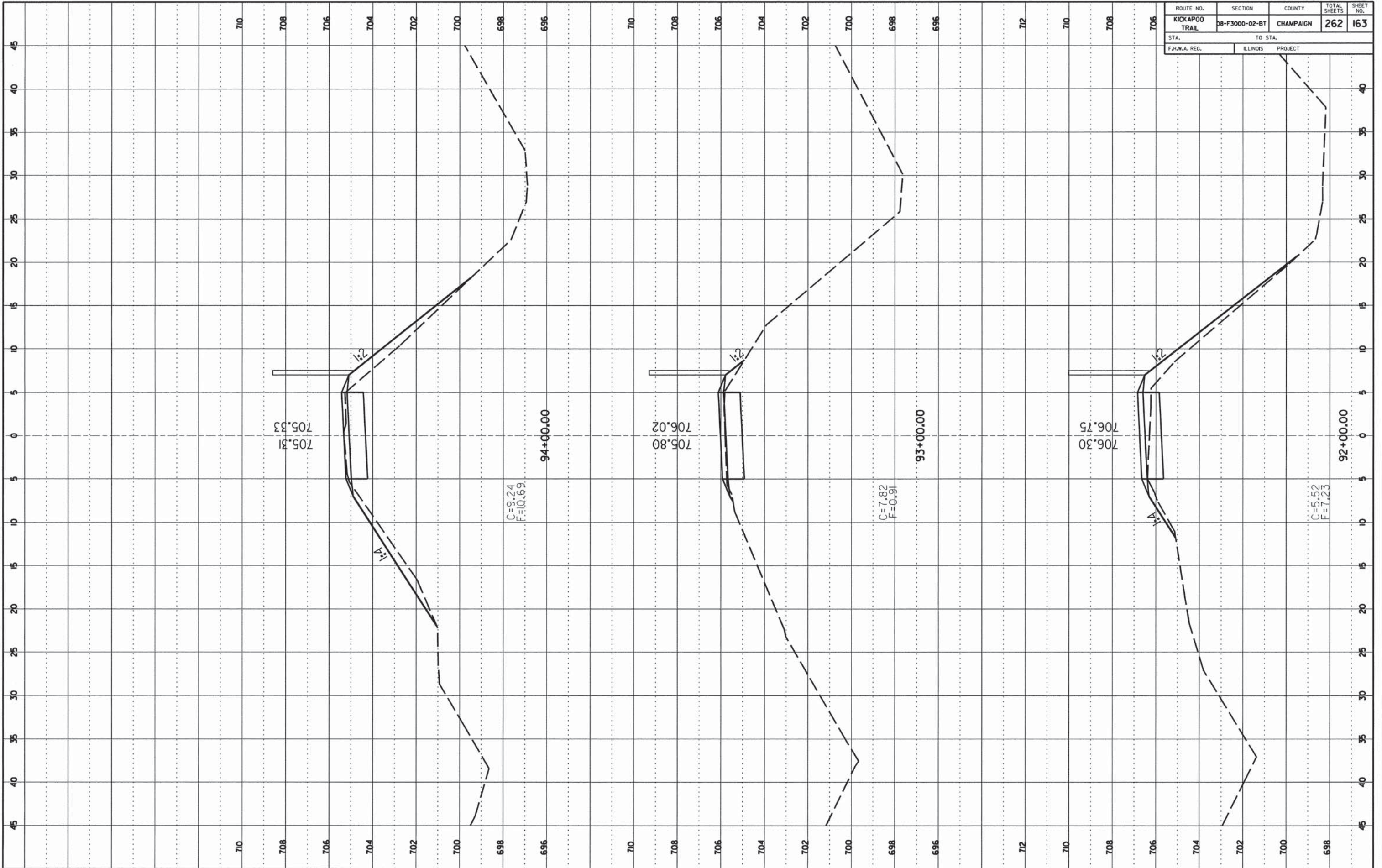

CONTRACT NO. 91520

ROUTE NO. KICKAPOO TRAIL	SECTION 08-F3000-02-BT	COUNTY CHAMPAIGN	TOTAL SHEETS 262	SHEET NO. 164
STA.		TO STA.		
F.H.W.A. REG.		ILLINOIS PROJECT		

FINAL SURVEY

NO. \_\_\_\_\_

DATE \_\_\_\_\_

BY \_\_\_\_\_

DATE \_\_\_\_\_

BY \_\_\_\_\_

DATE \_\_\_\_\_

BY \_\_\_\_\_

DATE \_\_\_\_\_

ORIGINAL SURVEY

NO. \_\_\_\_\_

DATE \_\_\_\_\_

BY \_\_\_\_\_

DATE \_\_\_\_\_

BY \_\_\_\_\_

DATE \_\_\_\_\_

BY \_\_\_\_\_

DATE \_\_\_\_\_

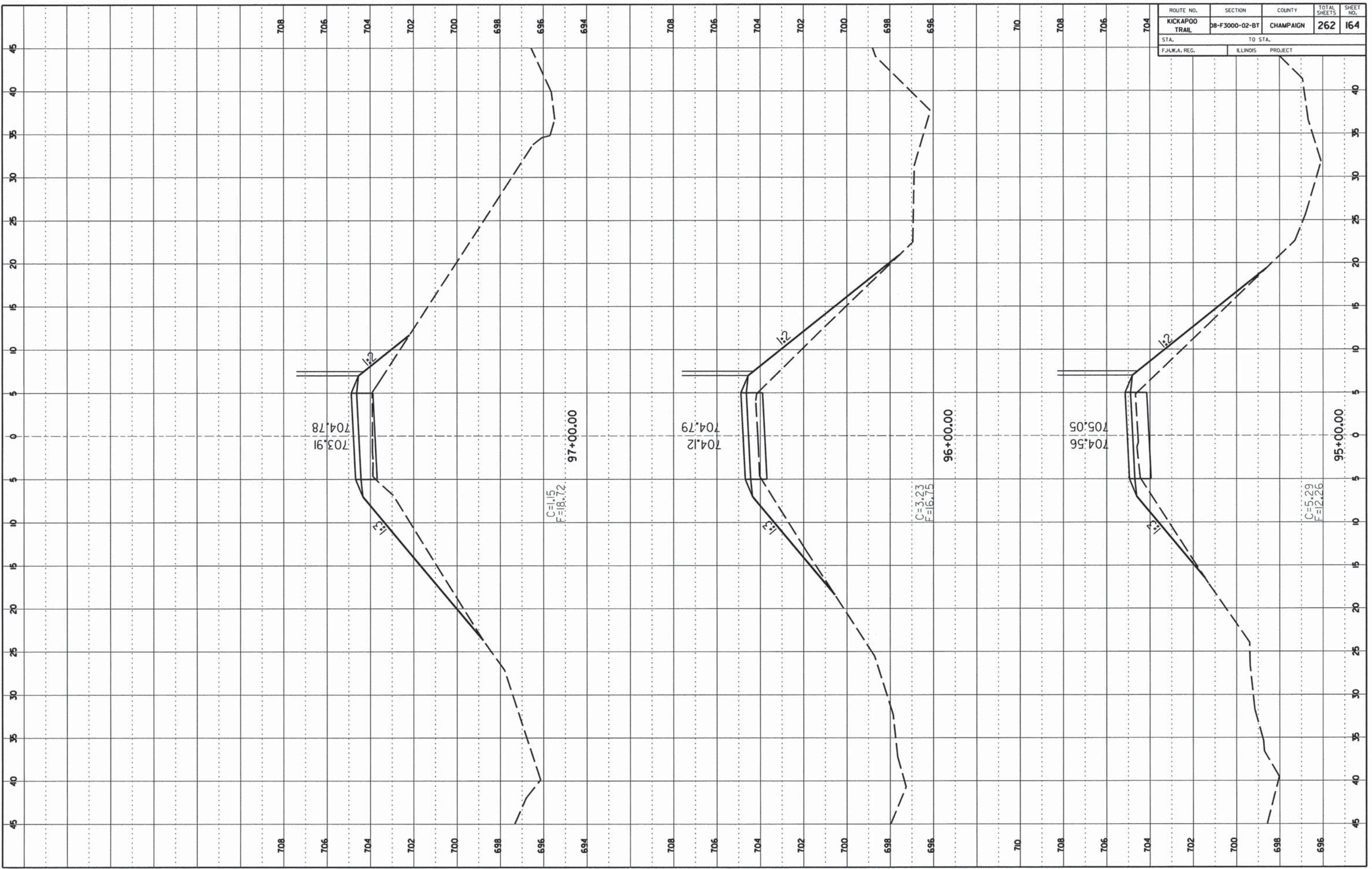

CCFPD KICKAPOO BIKE TRAIL

CHAMPAIGN COUNTY

CONTRACT NO. 91520

ROUTE NO.	SECTION	COUNTY	TOTAL SHEETS	SHEET NO.
KICKAPOO TRAIL	DB-F3000-02-BT	CHAMPAIGN	262	165
STA.	TO STA.			
F.H.W.A. REG.	ILLINOIS	PROJECT		

FINAL SURVEY  
 NO. \_\_\_\_\_  
 DATE \_\_\_\_\_

ORIGINAL SURVEY  
 NO. \_\_\_\_\_  
 DATE \_\_\_\_\_

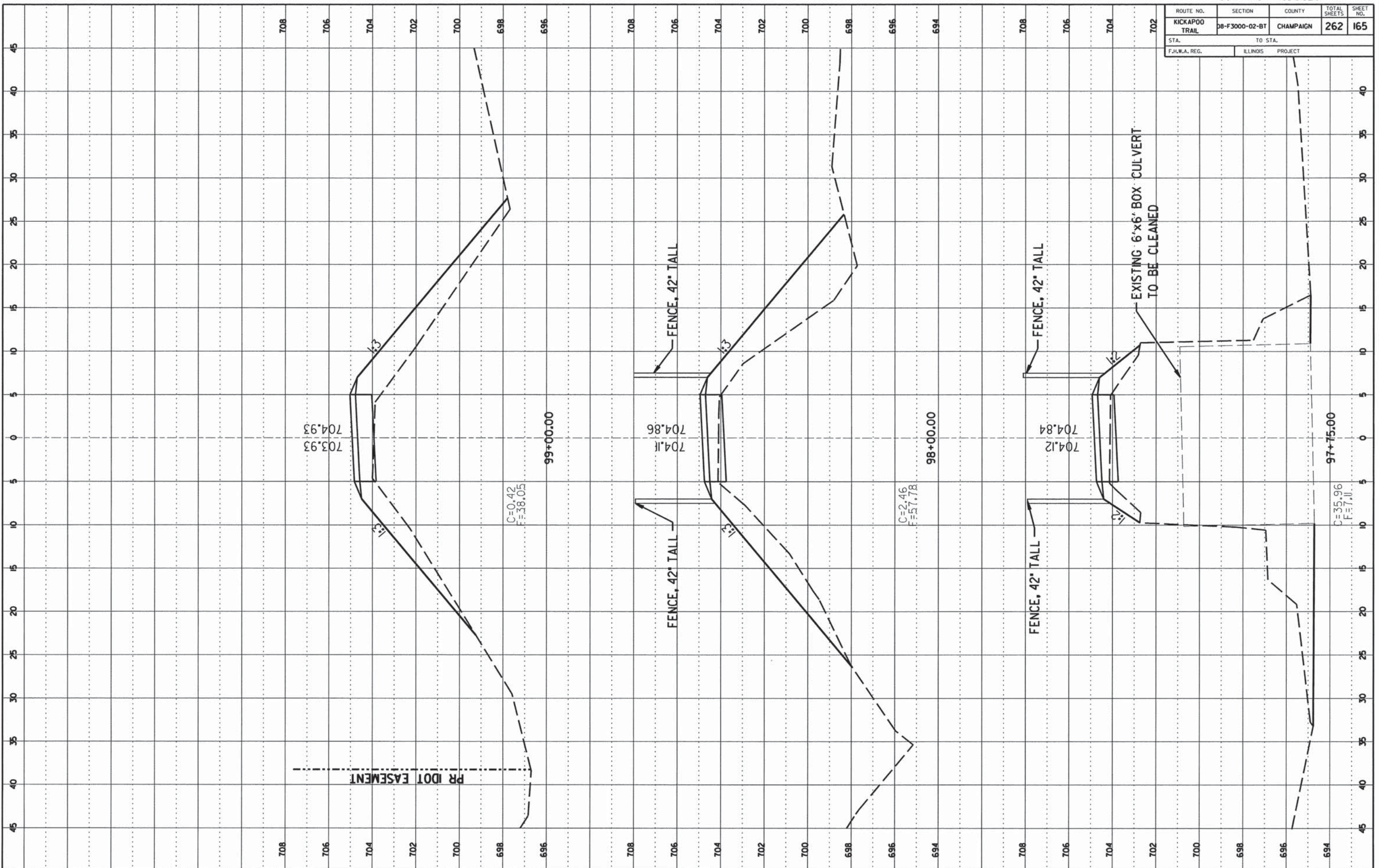

CCFPD KICKAPOO BIKE TRAIL CHAMPAIGN COUNTY



CONTRACT NO. 91520

ROUTE NO.	SECTION	COUNTY	TOTAL SHEETS	SHEET NO.
KICKAPOO TRAIL	08-F3000-02-BT	CHAMPAIGN	262	166
STA.		TO STA.		
F.M.W.A. REG.		ILLINOIS PROJECT		

FINAL SURVEY	BY	DATE

ORIGINAL SURVEY	BY	DATE

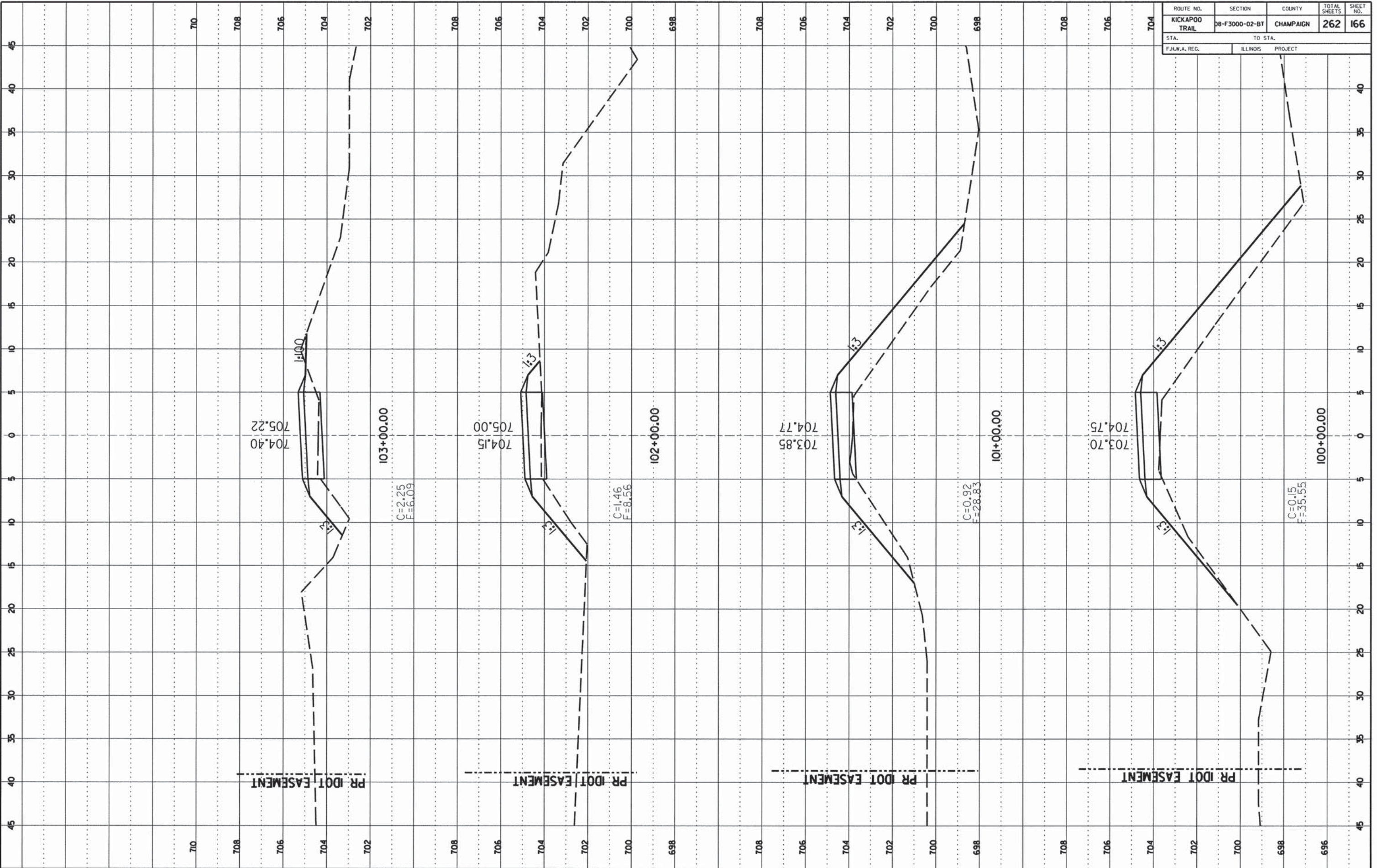

CONTRACT NO. 91520

ROUTE NO.	SECTION	COUNTY	TOTAL SHEETS	SHEET NO.
KICKAPOO TRAIL	08-F3000-02-BT	CHAMPAIGN	262	167
STA.		TO STA.		
F.H.W.A. REG.		ILLINOIS PROJECT		

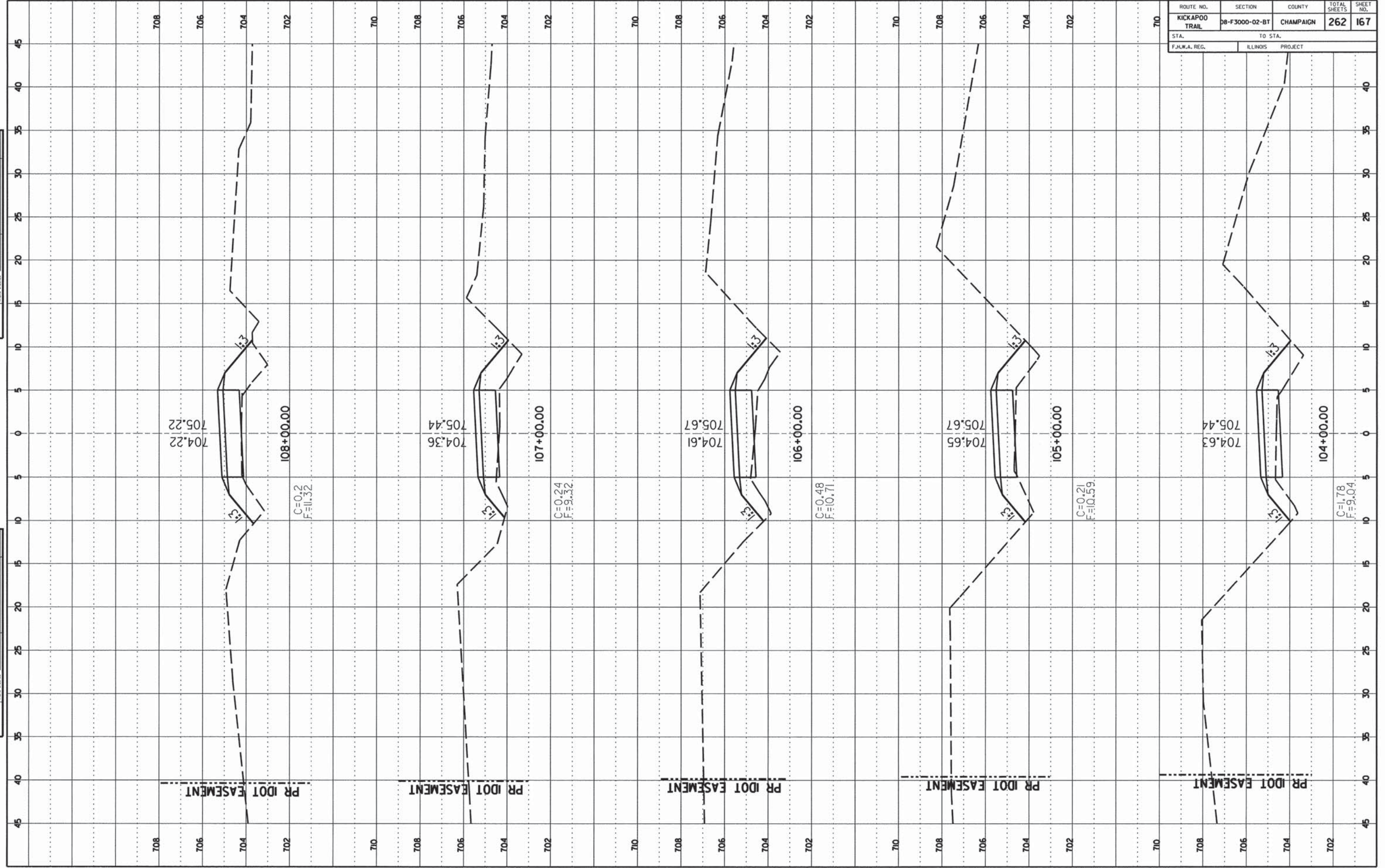

FINAL SURVEY  
 DATE: \_\_\_\_\_  
 BY: \_\_\_\_\_  
 CHECKED: \_\_\_\_\_  
 APPROVED: \_\_\_\_\_  
 TITLE: \_\_\_\_\_

ORIGINAL SURVEY  
 DATE: \_\_\_\_\_  
 BY: \_\_\_\_\_  
 CHECKED: \_\_\_\_\_  
 APPROVED: \_\_\_\_\_  
 TITLE: \_\_\_\_\_

CONTRACT NO. 91520

ROUTE NO.	SECTION	COUNTY	TOTAL SHEETS	SHEET NO.
KICKAPOO TRAIL	08-F3000-02-BT	CHAMPAIGN	262	168
STA.		TO STA.		
F.H.W.A. REG.		ILLINOIS PROJECT		

FINAL SURVEY  
 NO. \_\_\_\_\_  
 DATE \_\_\_\_\_

ORIGINAL SURVEY  
 NO. \_\_\_\_\_  
 DATE \_\_\_\_\_

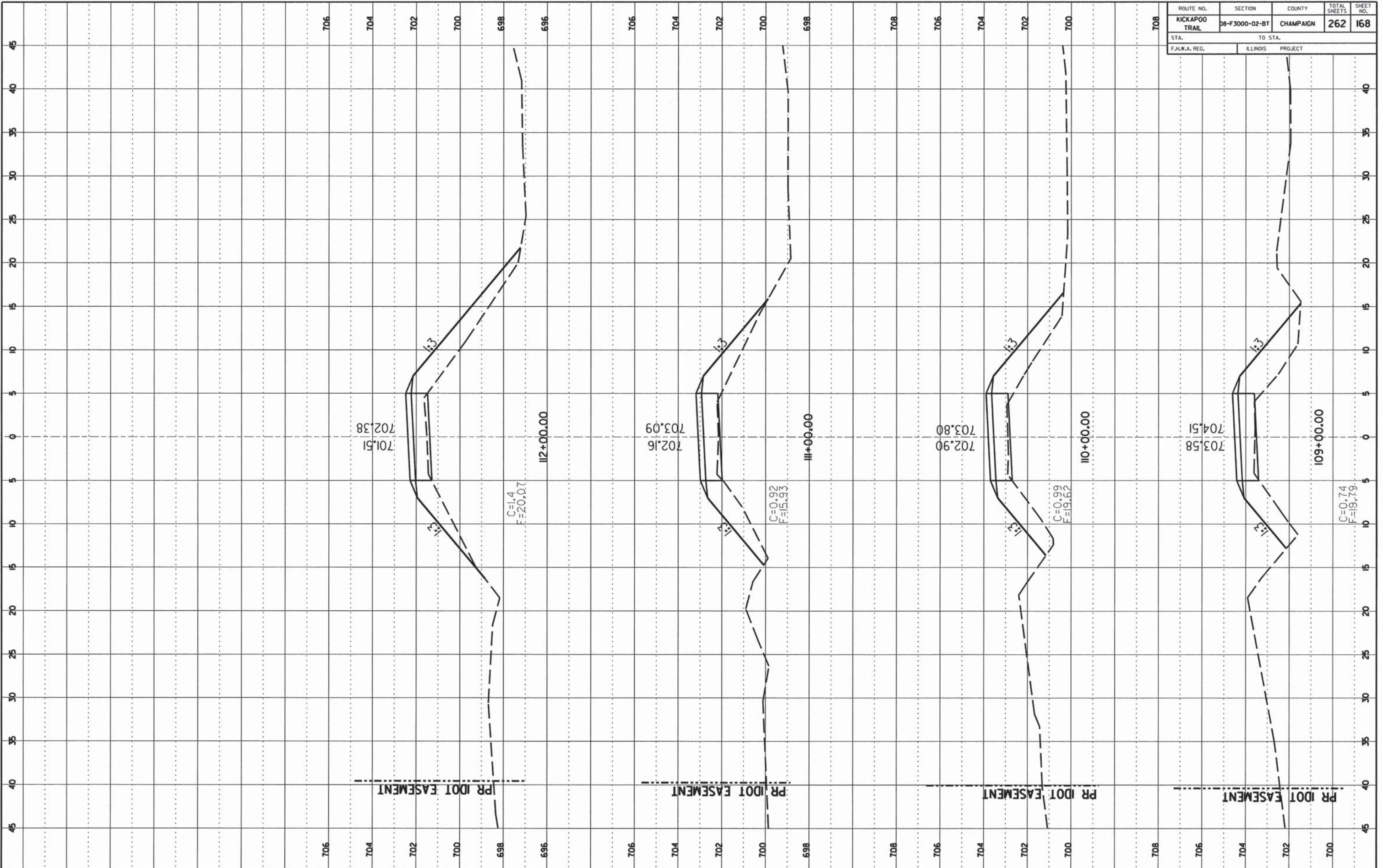

CCFPD KICKAPOO BIKE TRAIL CHAMPAIGN COUNTY

CONTRACT NO. 91520

ROUTE NO.	SECTION	COUNTY	TOTAL SHEETS	SHEET NO.
KICKAPOO TRAIL	DB-F3000-02-BT	CHAMPAIGN	262	169
STA.	TO STA.			
F.H.W.A. REG.	ILLINOIS PROJECT			

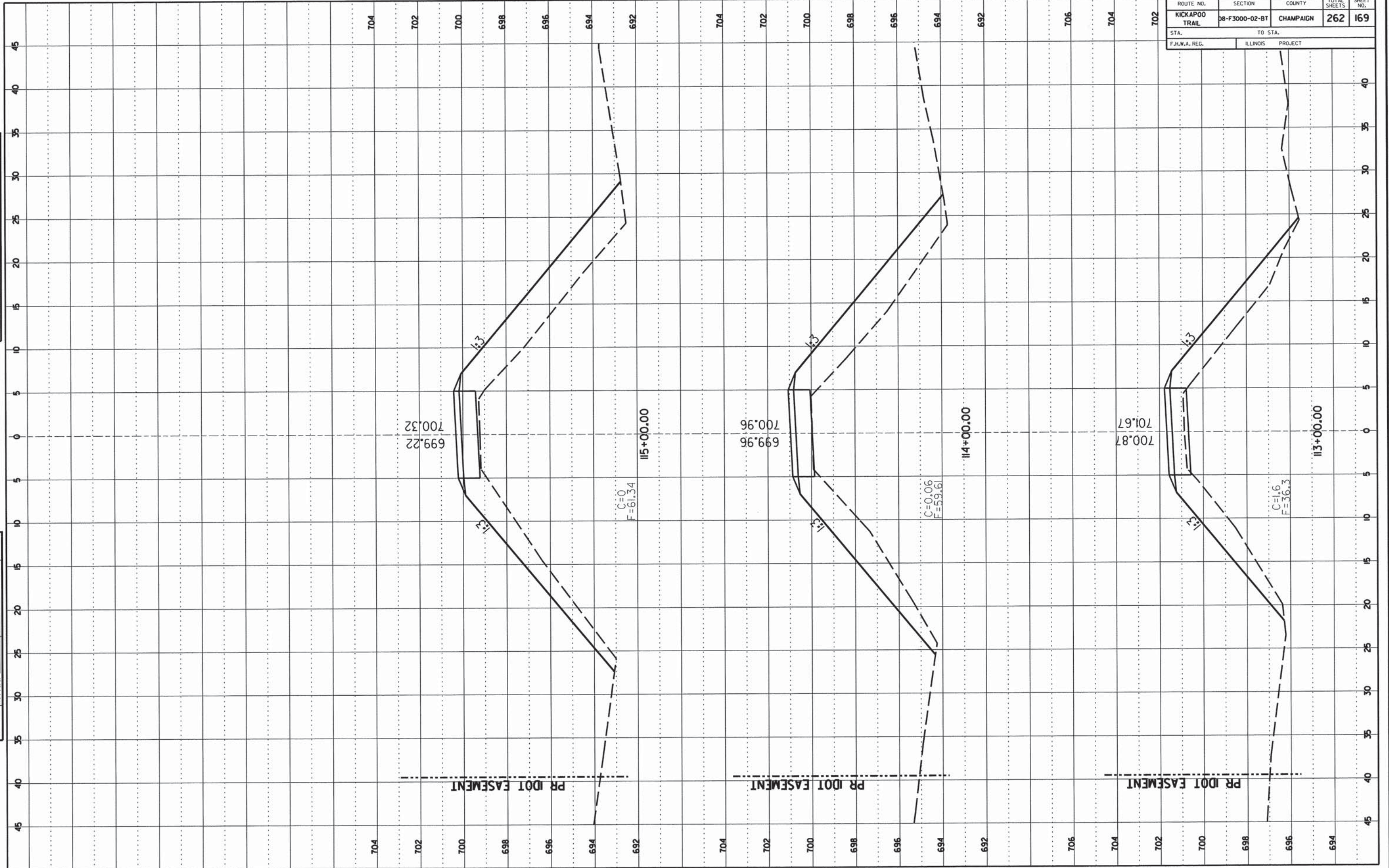

FINAL SURVEY

DATE	BY
NO. _____	NO. _____
DATE CHECKED	DATE CHECKED

ORIGINAL SURVEY

DATE	BY
NO. _____	NO. _____
DATE CHECKED	DATE CHECKED

CONTRACT NO. 91520

ROUTE NO.	SECTION	COUNTY	TOTAL SHEETS	SHEET NO.
KICKAPOO TRAIL	08-F3000-02-BT	CHAMPAIGN	262	170
STA. TO STA.		ILLINOIS PROJECT		
F.I.L.W.A. REG.				

FINAL SURVEY

DATE	
BY	
PROJECT	
PLATTED	
TEMPERATURE	
WIND	
NO. OF RECORDS	

ORIGINAL SURVEY

DATE	
BY	
PROJECT	
PLATTED	
TEMPERATURE	
WIND	
NO. OF RECORDS	

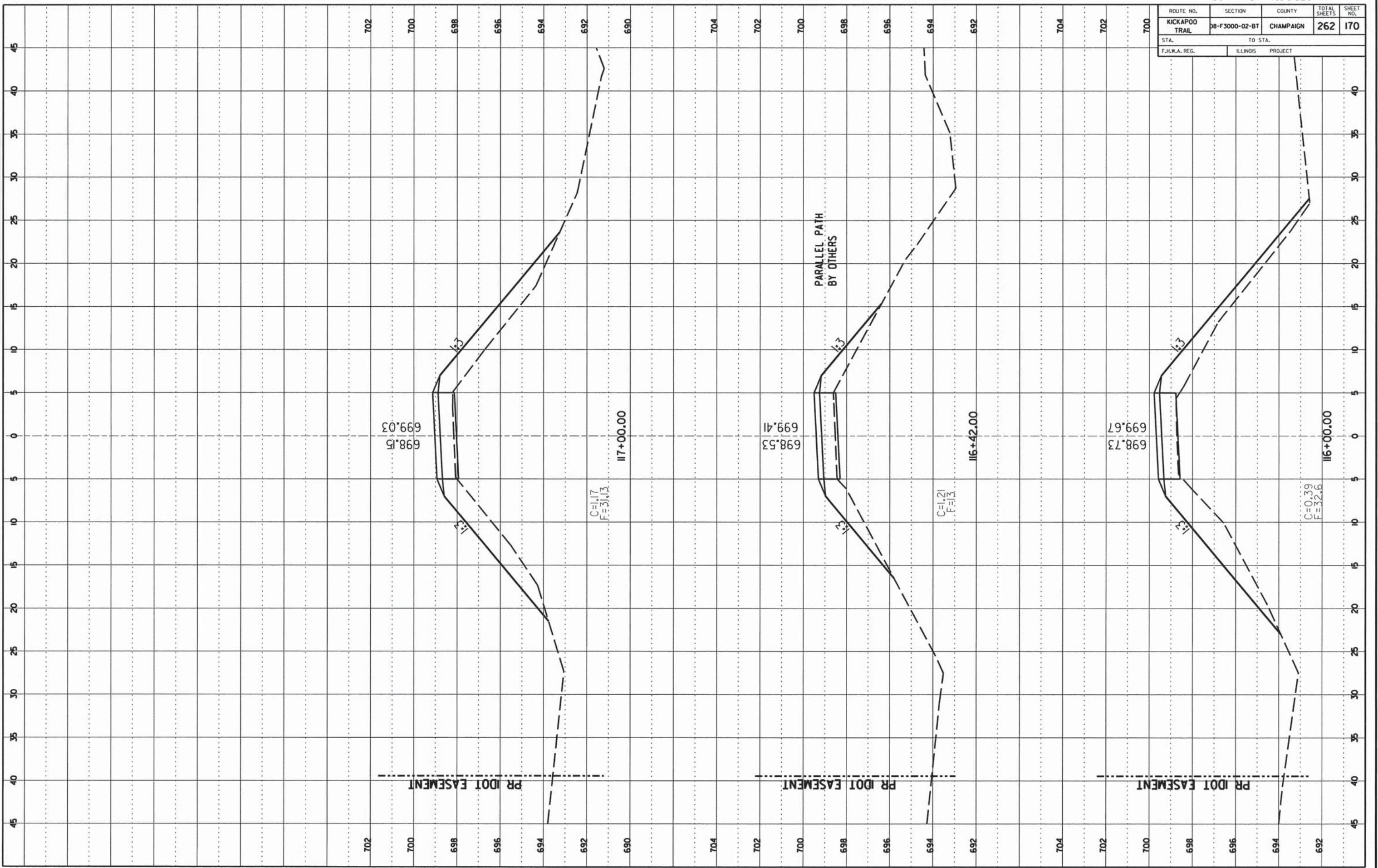

CCFPD KICKAPOO BIKE TRAIL CHAMPAIGN COUNTY

CONTRACT NO. 91520

ROUTE NO.	SECTION	COUNTY	TOTAL SHEETS	SHEET NO.
KICKAPOO TRAIL	08-F3000-02-BT	CHAMPAIGN	262	171
STA. TO STA.		ILLINOIS PROJECT		
F.H.W.A. REG.				

FINAL SURVEY  
 NO. \_\_\_\_\_  
 DATE \_\_\_\_\_  
 BY \_\_\_\_\_  
 CHECKED \_\_\_\_\_  
 SURVEYED \_\_\_\_\_  
 PLATTED \_\_\_\_\_  
 TYPED \_\_\_\_\_  
 AREA CHECKED \_\_\_\_\_

ORIGINAL SURVEY  
 NO. \_\_\_\_\_  
 DATE \_\_\_\_\_  
 BY \_\_\_\_\_  
 CHECKED \_\_\_\_\_  
 SURVEYED \_\_\_\_\_  
 PLATTED \_\_\_\_\_  
 TYPED \_\_\_\_\_  
 AREA CHECKED \_\_\_\_\_

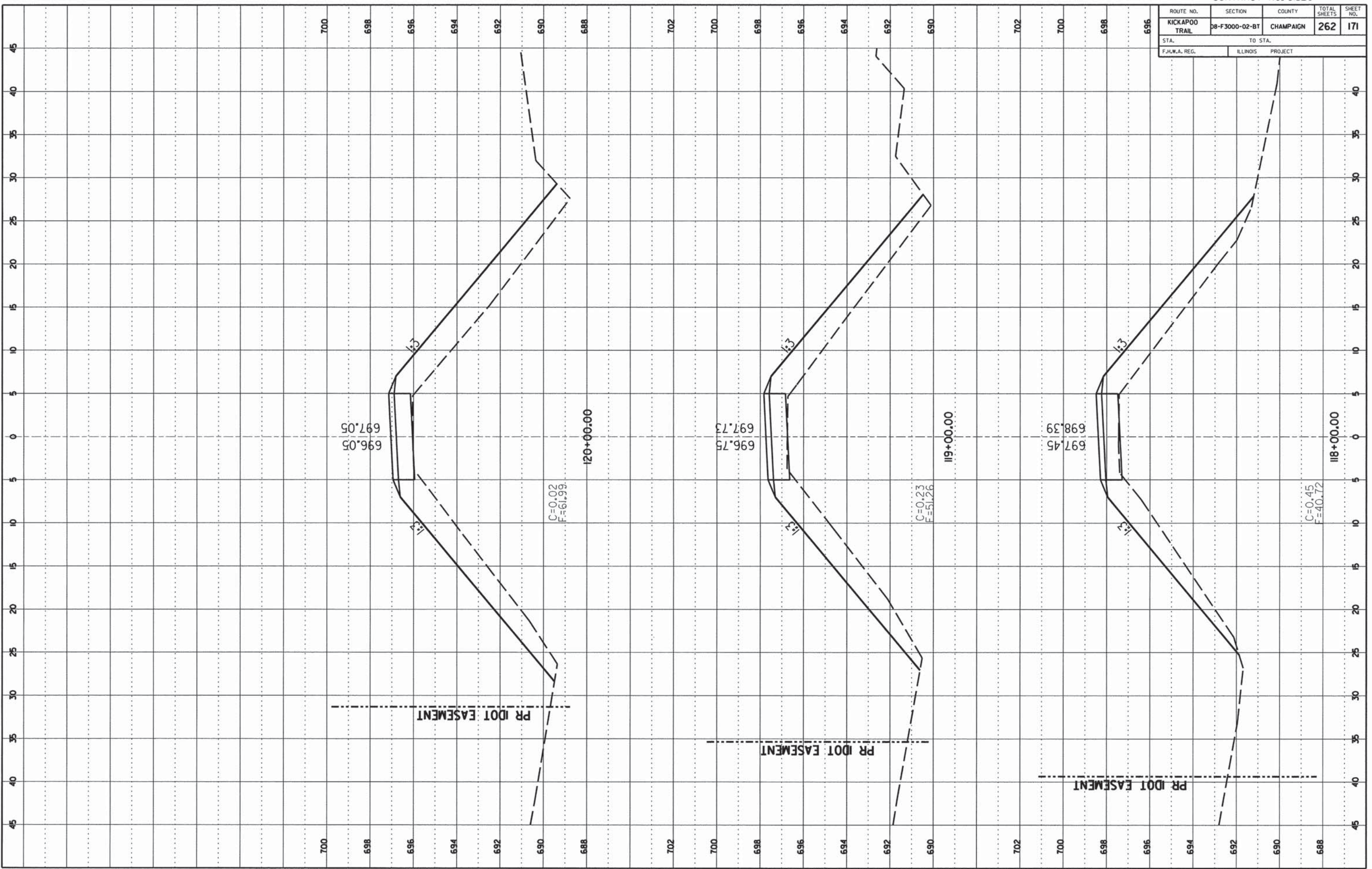

CCFPD KICKAPOO BIKE TRAIL

CHAMPAIGN COUNTY

CONTRACT NO. 91520

ROUTE NO.	SECTION	COUNTY	TOTAL SHEETS	SHEET NO.
KICKAPOO TRAIL	08-F3000-02-BT	CHAMPAIGN	262	172
STA. TO STA.		ILLINOIS PROJECT		
F.H.W.A. REG.				

FINAL SURVEY

PROJECT	DATE
NO. _____	_____
NOTE BOOK NO. _____	
AREA ACRES _____	

ORIGINAL SURVEY

PROJECT	DATE
NO. _____	_____
NOTE BOOK NO. _____	
AREA ACRES _____	

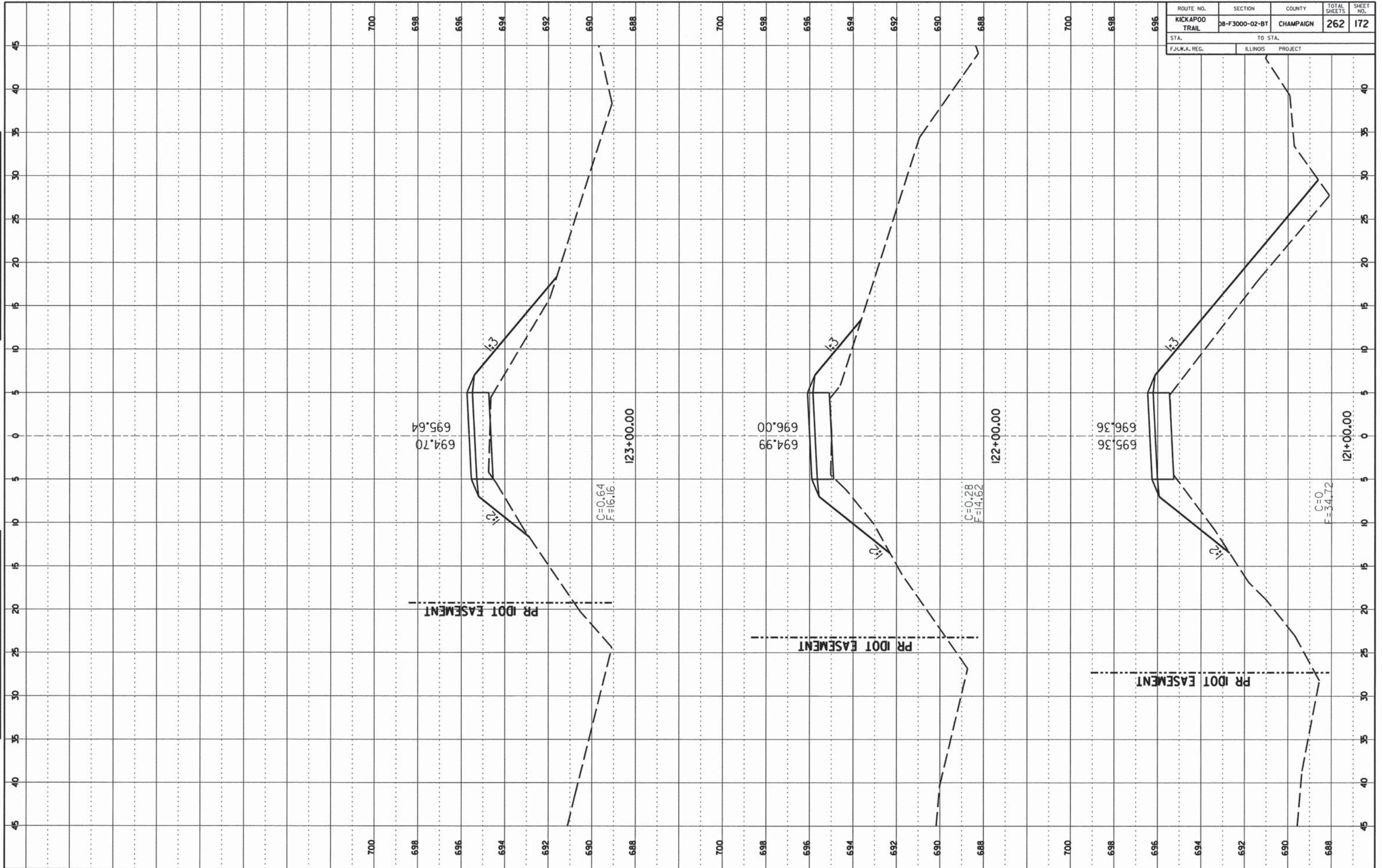

CONTRACT NO. 91520

ROUTE NO.	SECTION	COUNTY	TOTAL SHEETS	SHEET NO.
KICKAPOO TRAIL	08-F3000-02-BT	CHAMPAIGN	262	173
STA.		TO STA.		
F.H.W.A. REG.		ILLINOIS PROJECT		

NO.	DATE	BY

FINAL SURVEY  
 DRAWING NO. \_\_\_\_\_  
 DATE \_\_\_\_\_  
 BY \_\_\_\_\_  
 CHECKED \_\_\_\_\_  
 DATE \_\_\_\_\_

NO.	DATE	BY

ORIGINAL SURVEY  
 DRAWING NO. \_\_\_\_\_  
 DATE \_\_\_\_\_  
 BY \_\_\_\_\_  
 CHECKED \_\_\_\_\_  
 DATE \_\_\_\_\_

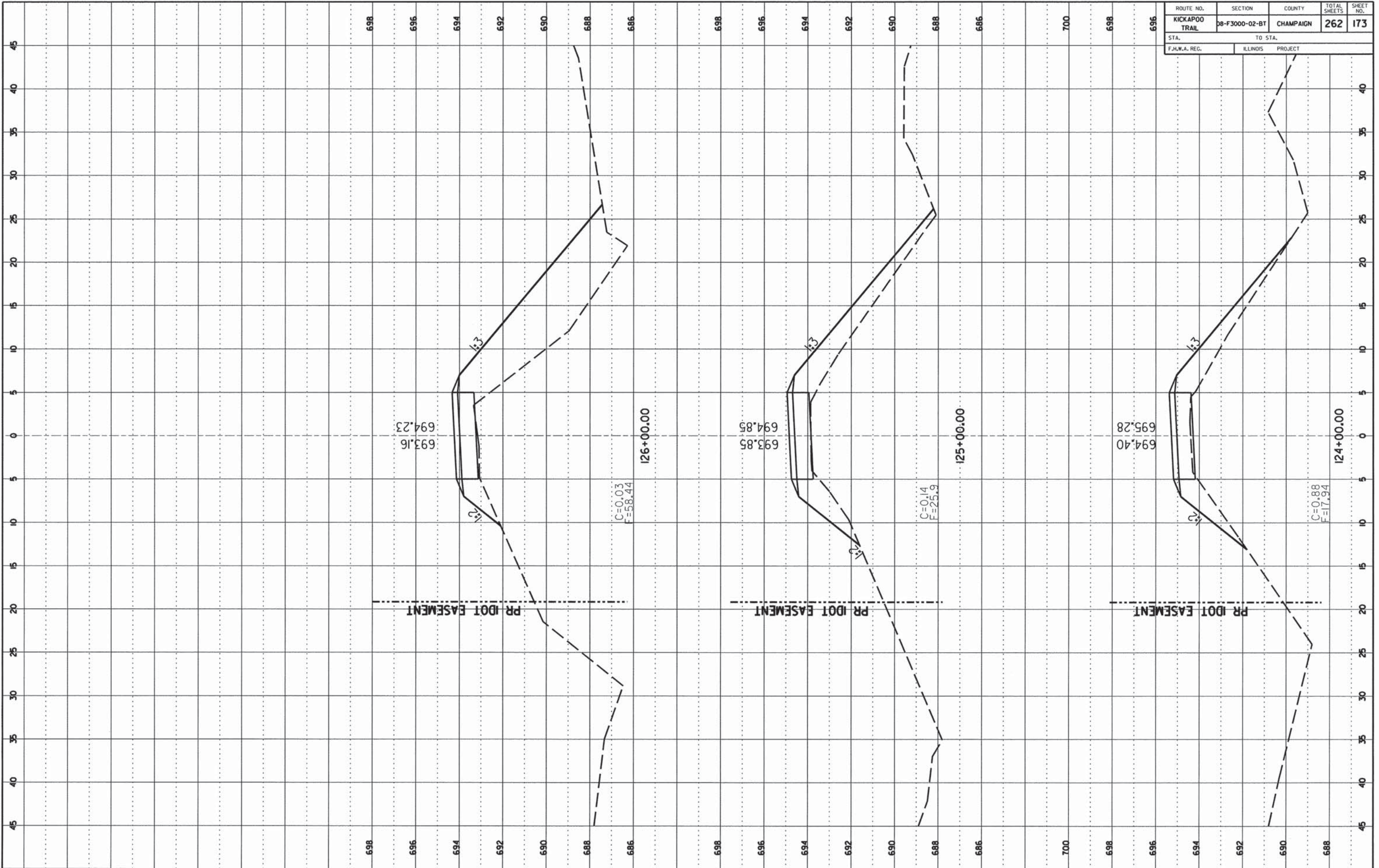

CCFPD KICKAPOO BIKE TRAIL

CHAMPAIGN COUNTY

SHEET 173 OF 262 SHEETS 13-620A



CONTRACT NO. 91520

ROUTE NO.	SECTION	COUNTY	TOTAL SHEETS	SHEET NO.
KICKAPOO TRAIL	08-F3000-02-BT	CHAMPAIGN	262	174
STA. TO STA.		F.H.W.A. REG. ILLINOIS PROJECT		

NO.	DATE	BY	REVISION

NO.	DATE	BY	REVISION

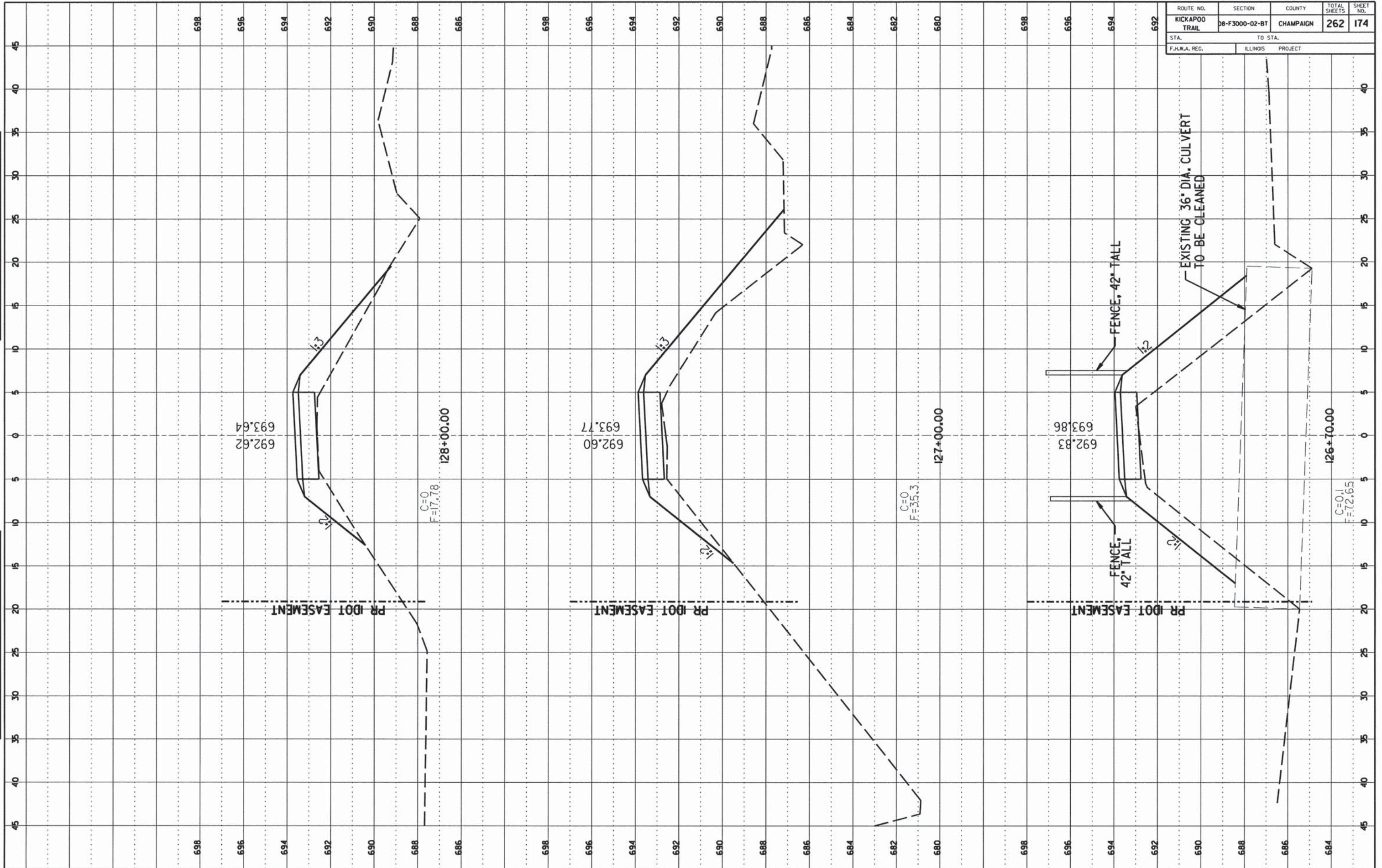

CONTRACT NO. 91520

ROUTE NO.	SECTION	COUNTY	TOTAL SHEETS	SHEET NO.
KICKAPOO TRAIL	08-F3000-02-BT	CHAMPAIGN	262	175
STA.		TO STA.		
F.H.W.A. REG.		ILLINOIS PROJECT		

FINAL SURVEY  
 SURVEY NO. \_\_\_\_\_  
 DATE \_\_\_\_\_

ORIGINAL SURVEY  
 SURVEY NO. \_\_\_\_\_  
 DATE \_\_\_\_\_

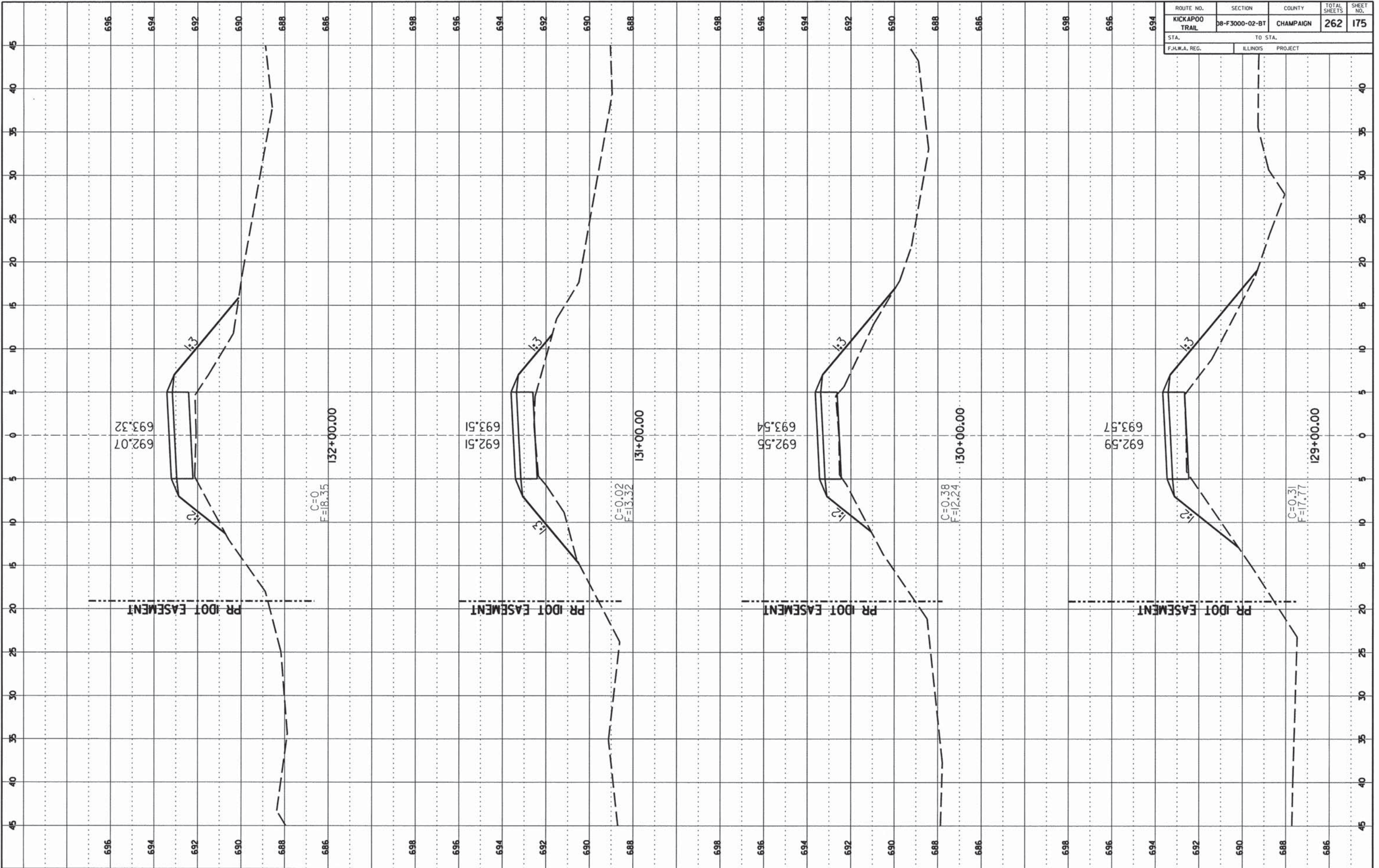

CCFPD KICKAPOO BIKE TRAIL CHAMPAIGN COUNTY

CONTRACT NO. 91520

ROUTE NO.	SECTION	COUNTY	TOTAL SHEETS	SHEET NO.
KICKAPOO TRAIL	08-F3000-02-BT	CHAMPAIGN	262	176
STA.	TO STA.			
F.H.W.A. REG.	ILLINOIS	PROJECT		

FINAL SURVEY	DATE
REVISIONS	
NO.	
DATE	
BY	
PROJECT	
TEMPLATE	
AREA	
AREA	
AREA	

ORIGINAL SURVEY	DATE
REVISIONS	
NO.	
DATE	
BY	
PROJECT	
TEMPLATE	
AREA	
AREA	
AREA	

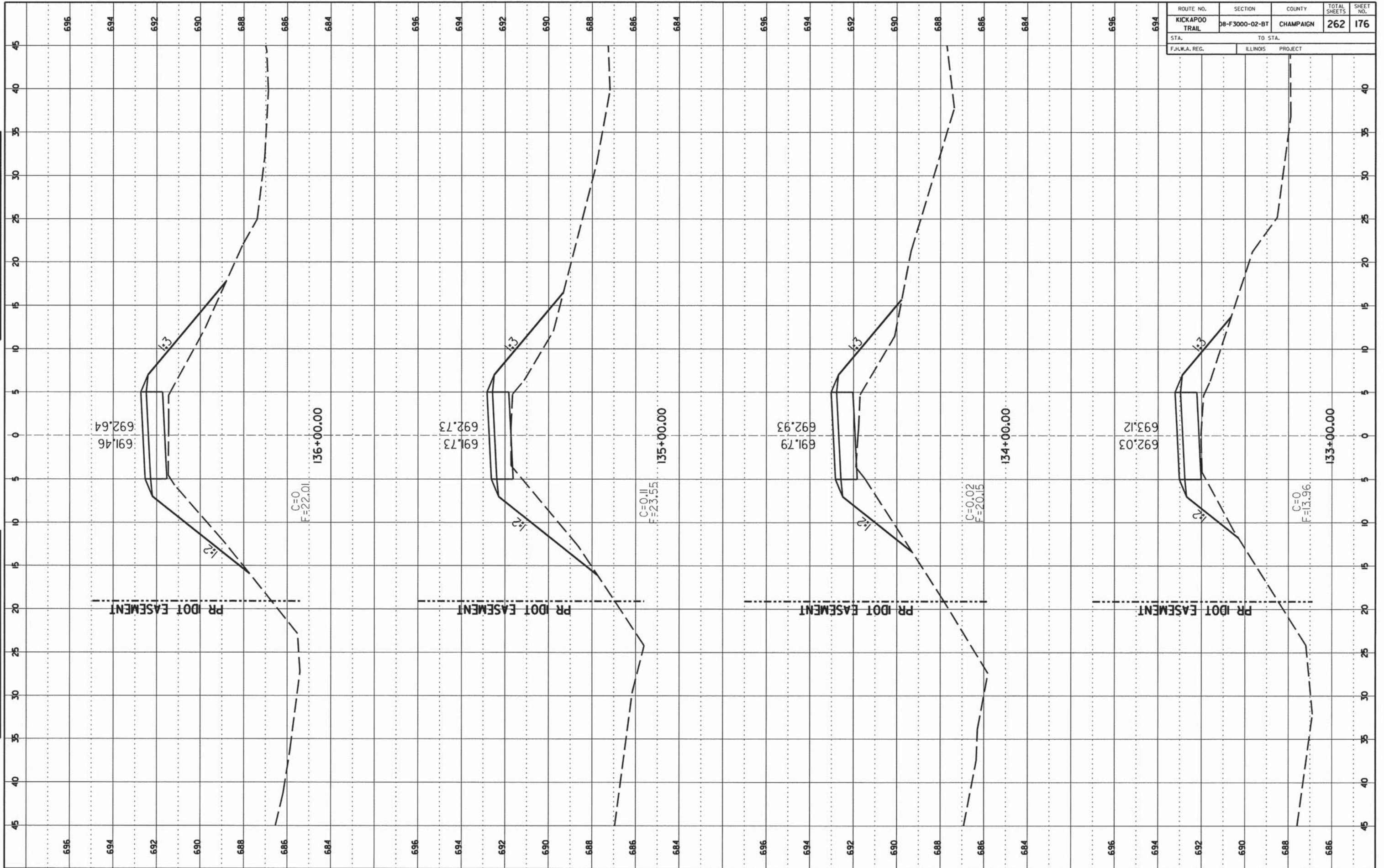

CONTRACT NO. 91520

ROUTE NO.	SECTION	COUNTY	TOTAL SHEETS	SHEET NO.
KICKAPOO TRAIL	08-F3000-02-BT	CHAMPAIGN	262	177
STA. F.H.W.A. REG.		TO STA. ILLINOIS PROJECT		

DATE	
BY	
FINAL SURVEY	
NOTE BOOK NO.	
AREA CHECKED	

DATE	
BY	
ORIGINAL SURVEY	
NOTE BOOK NO.	
AREA CHECKED	

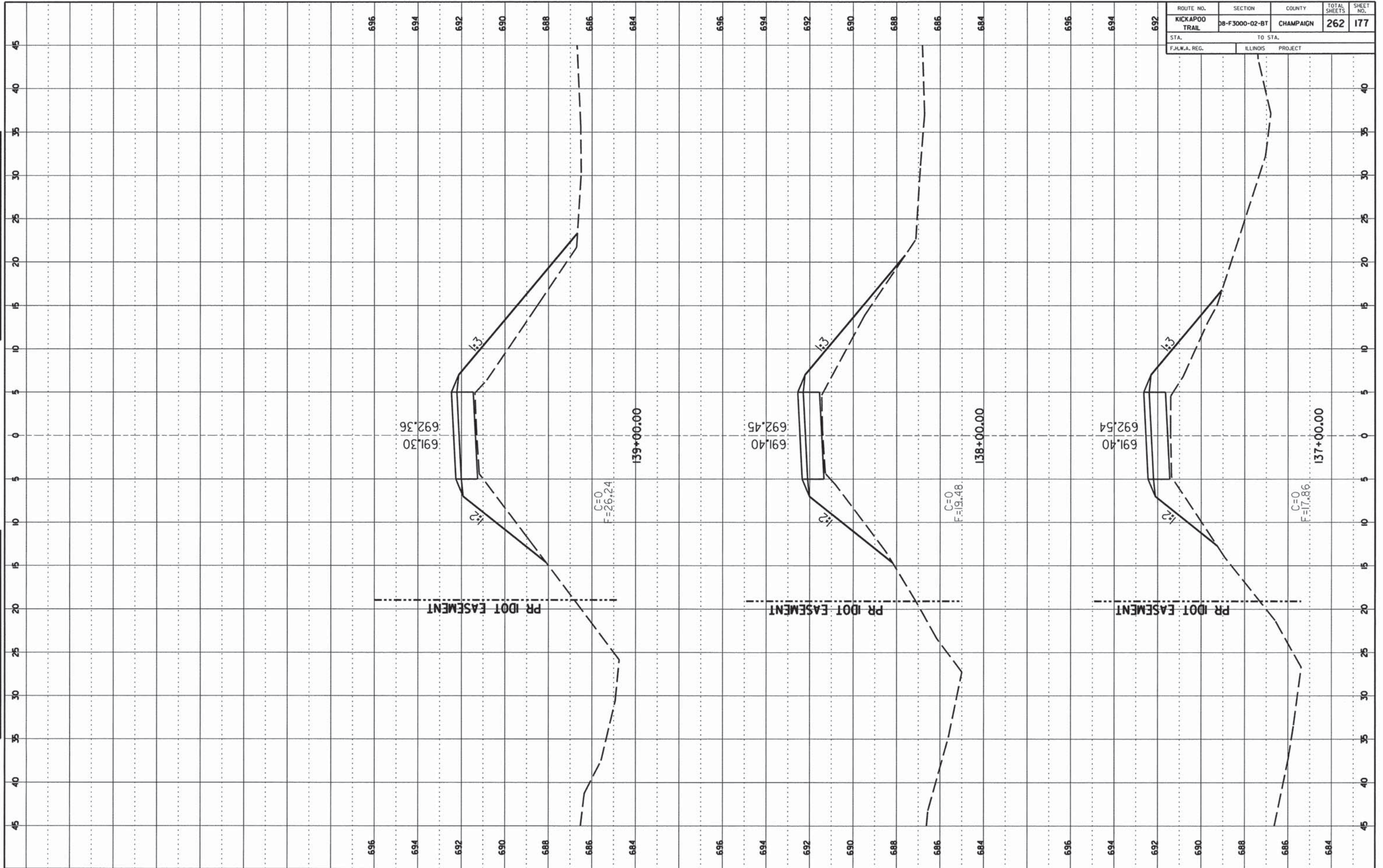

CCFPD KICKAPOO BIKE TRAIL

CHAMPAIGN COUNTY

SHEET 177 OF 262 SHEETS 13-620A

CONTRACT NO. 91520

ROUTE NO.	SECTION	COUNTY	TOTAL SHEETS	SHEET NO.
KICKAPOO TRAIL	08-F3000-02-BT	CHAMPAIGN	262	178
STA.	TO STA.			
F.H.W.A. REG.	ILLINOIS	PROJECT		

FINAL SURVEY

DATE	
BY	
REVISION	
NO.	

ORIGINAL SURVEY

DATE	
BY	
REVISION	
NO.	

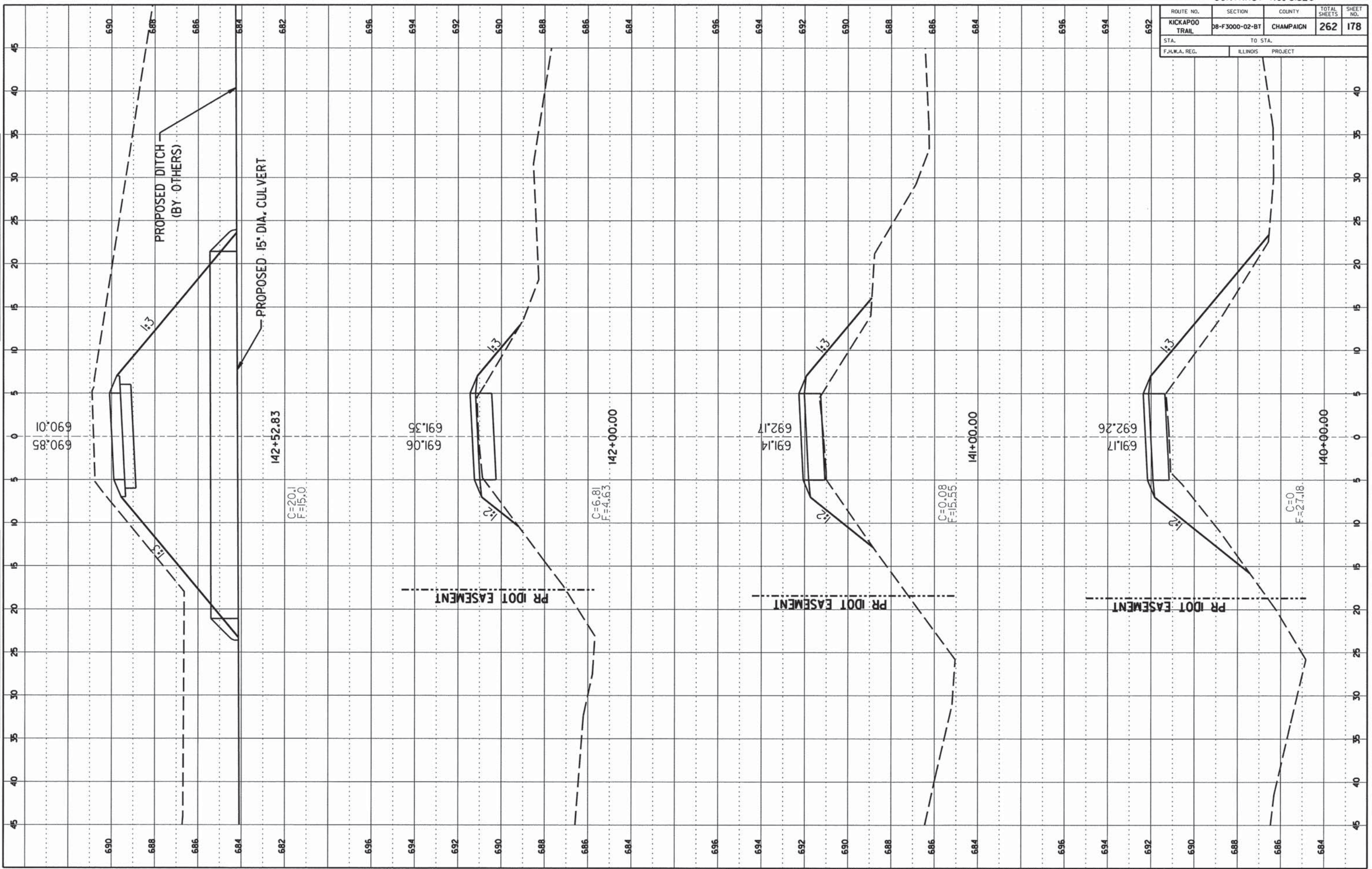

CCFPD KICKAPOO BIKE TRAIL

CHAMPAIGN COUNTY

CONTRACT NO. 91520

ROUTE NO.	SECTION	COUNTY	TOTAL SHEETS	SHEET NO.
KICKAPOO TRAIL	08-F3000-02-BT	CHAMPAIGN	262	179
STA.	TO STA.			
F.H.W.A. REG.	ILLINOIS	PROJECT		

FINAL SURVEY

DATE: \_\_\_\_\_

BY: \_\_\_\_\_

NO. \_\_\_\_\_

AREA COVERED: \_\_\_\_\_

ORIGINAL SURVEY

DATE: \_\_\_\_\_

BY: \_\_\_\_\_

NO. \_\_\_\_\_

AREA COVERED: \_\_\_\_\_

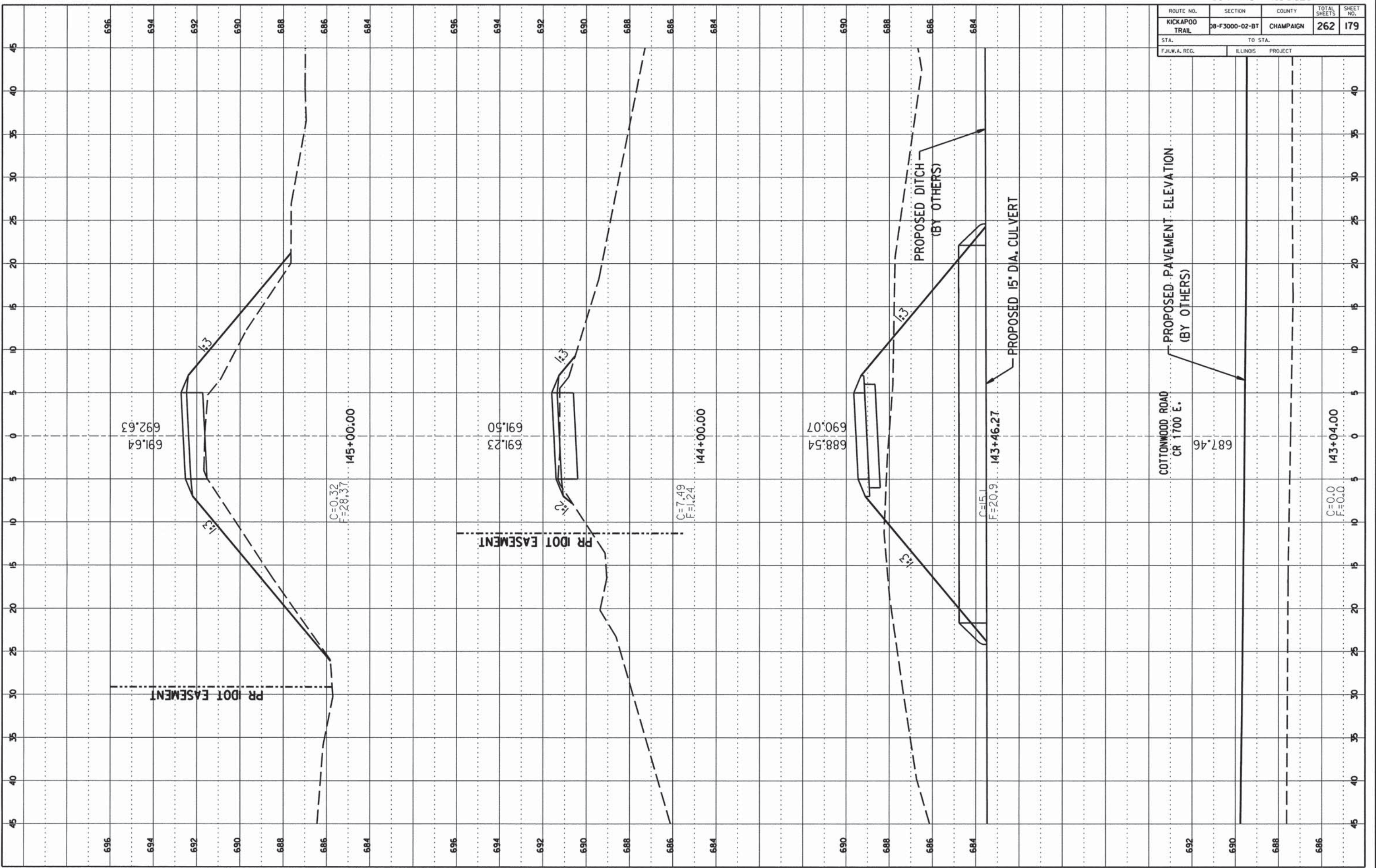

CONTRACT NO. 91520

ROUTE NO.	SECTION	COUNTY	TOTAL SHEETS	SHEET NO.
KICKAPOO TRAIL	08-F3000-02-BT	CHAMPAIGN	262	180
STA.		TO STA.		
F.H.W.A. REG.		ILLINOIS PROJECT		

FINAL SURVEY

DATE: \_\_\_\_\_

BY: \_\_\_\_\_

PROJECT: \_\_\_\_\_

PLATTED: \_\_\_\_\_

NOTE BOOK NO.: \_\_\_\_\_

MARKED: \_\_\_\_\_

AREAS RECORDED: \_\_\_\_\_

ORIGINAL SURVEY

DATE: \_\_\_\_\_

BY: \_\_\_\_\_

PROJECT: \_\_\_\_\_

PLATTED: \_\_\_\_\_

NOTE BOOK NO.: \_\_\_\_\_

MARKED: \_\_\_\_\_

AREAS RECORDED: \_\_\_\_\_

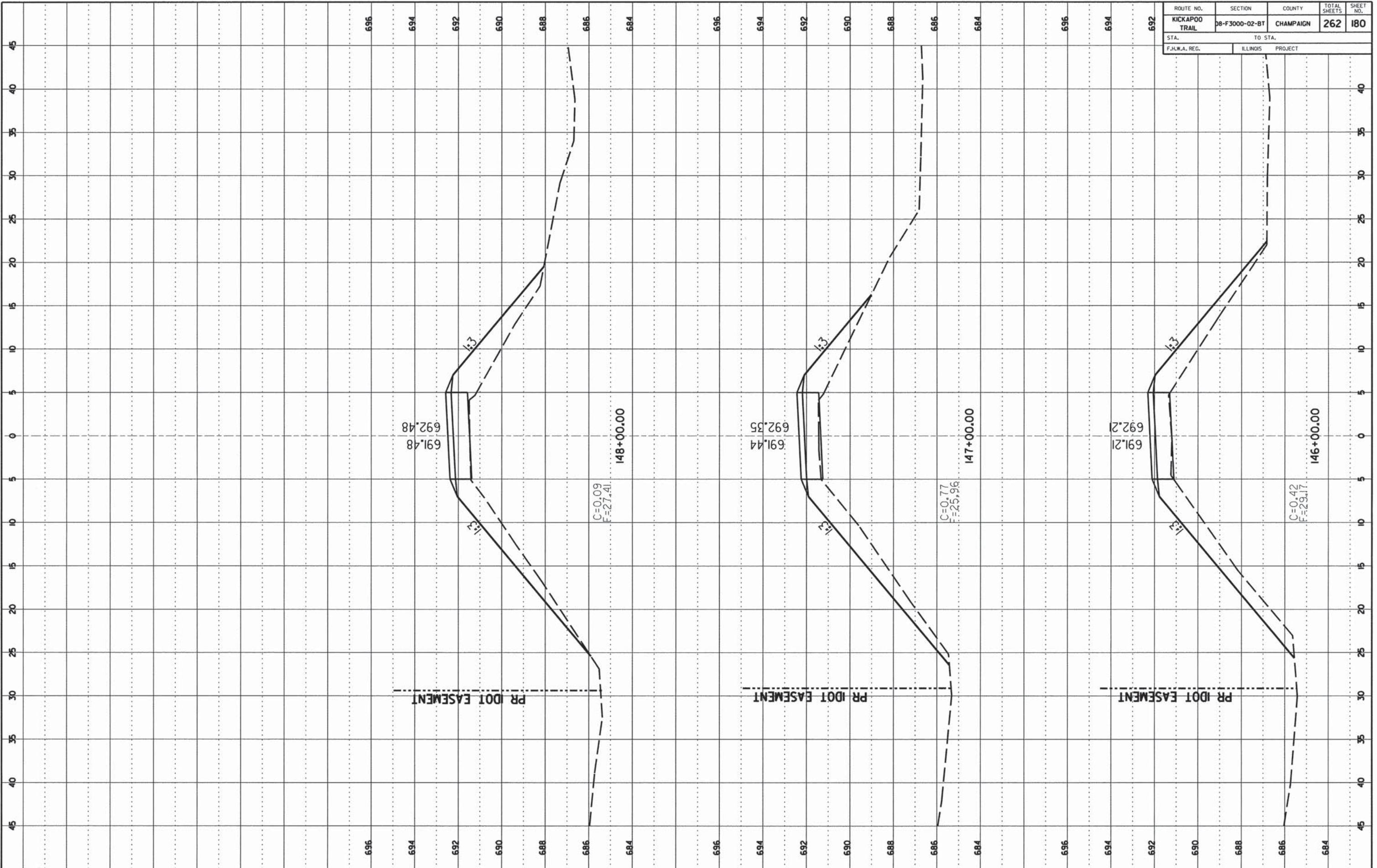

CCFPD KICKAPOO BIKE TRAIL CHAMPAIGN COUNTY

CONTRACT NO. 91520

ROUTE NO.	SECTION	COUNTY	TOTAL SHEETS	SHEET NO.
KICKAPOO TRAIL	08-F3000-02-BT	CHAMPAIGN	262	181
STA. TO STA.		ILLINOIS PROJECT		
F.H.W.A. REG.		PROJECT		

FINAL SURVEY

DATE: \_\_\_\_\_

NO. \_\_\_\_\_

NO. \_\_\_\_\_

NO. \_\_\_\_\_

NO. \_\_\_\_\_

NO. \_\_\_\_\_

ORIGINAL SURVEY

DATE: \_\_\_\_\_

NO. \_\_\_\_\_

NO. \_\_\_\_\_

NO. \_\_\_\_\_

NO. \_\_\_\_\_

NO. \_\_\_\_\_

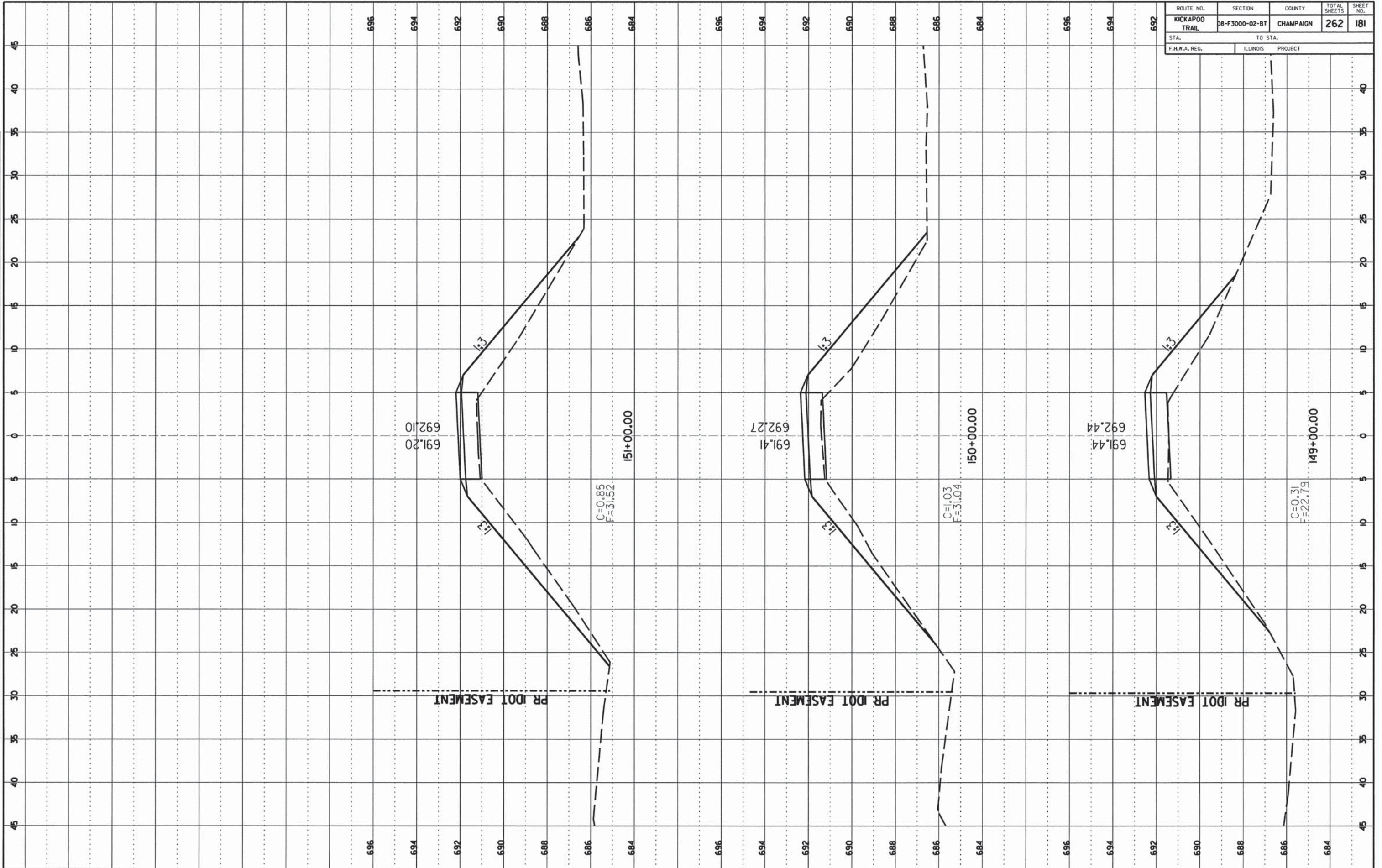



CONTRACT NO. 91520

ROUTE NO.	SECTION	COUNTY	TOTAL SHEETS	SHEET NO.
KICKAPOO TRAIL	08-F3000-02-BT	CHAMPAIGN	262	182
STA.	TO STA.			
F.H.W.A. REG.	ILLINOIS	PROJECT		

FINAL SURVEY

DATE: \_\_\_\_\_ BY: \_\_\_\_\_

NO. \_\_\_\_\_

PROJECT: \_\_\_\_\_

PLAT: \_\_\_\_\_

NOTE BOOK NO. \_\_\_\_\_

FIELD BOOK NO. \_\_\_\_\_

ORIGINAL SURVEY

DATE: \_\_\_\_\_ BY: \_\_\_\_\_

NO. \_\_\_\_\_

PROJECT: \_\_\_\_\_

PLAT: \_\_\_\_\_

NOTE BOOK NO. \_\_\_\_\_

FIELD BOOK NO. \_\_\_\_\_

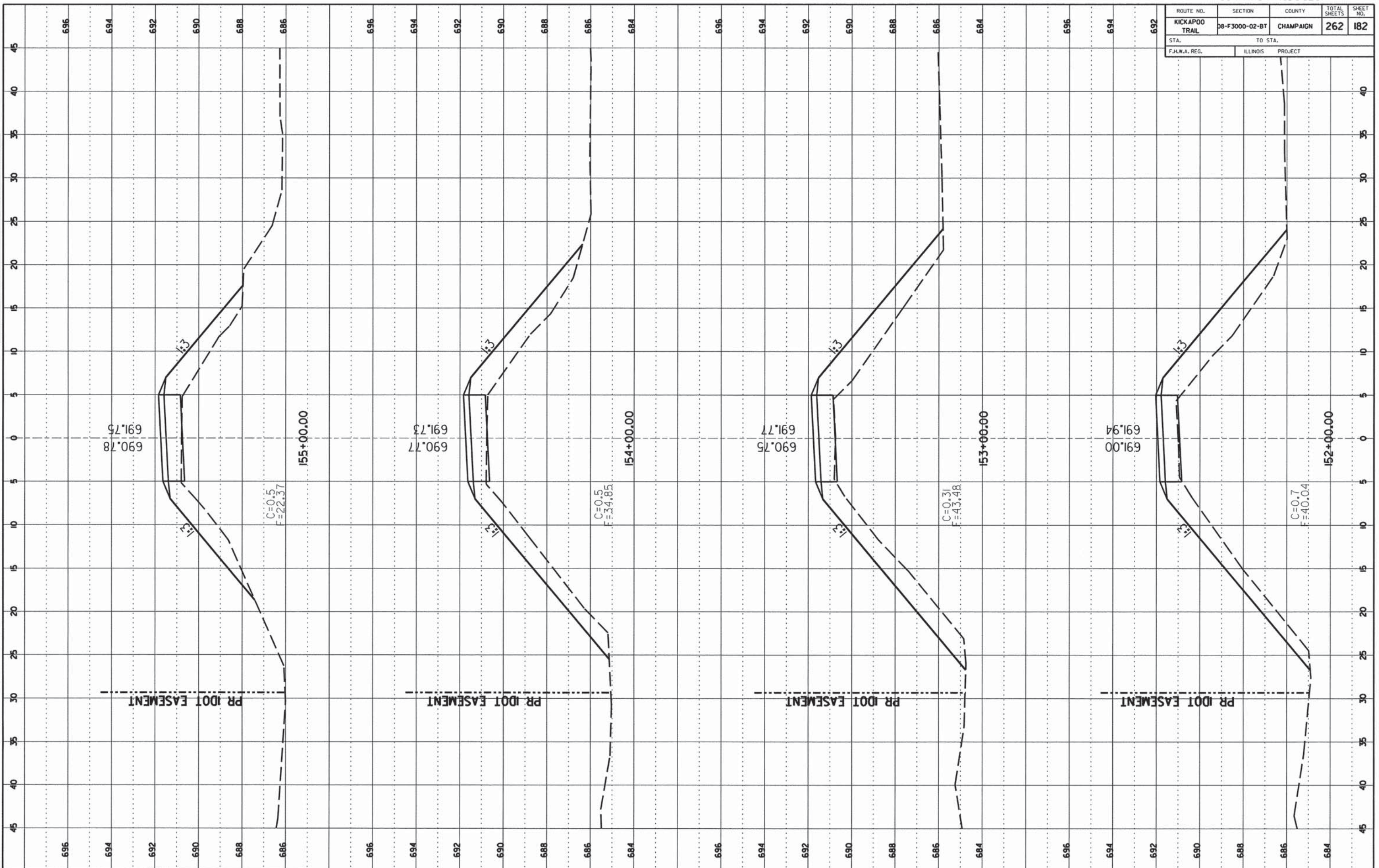

CCFPD KICKAPOO BIKE TRAIL

CHAMPAIGN COUNTY

SHEET 182 OF 262 SHEETS 13-620A

CONTRACT NO. 91520

ROUTE NO.	SECTION	COUNTY	TOTAL SHEETS	SHEET NO.
KICKAPOO TRAIL	D8-F3000-02-BT	CHAMPAIGN	262	183
STA. F.H.W.A. REG.		TO STA. ILLINOIS PROJECT		

FINAL SURVEY

DATE: \_\_\_\_\_

BY: \_\_\_\_\_

NO. \_\_\_\_\_

DATE: \_\_\_\_\_

BY: \_\_\_\_\_

NO. \_\_\_\_\_

ORIGINAL SURVEY

DATE: \_\_\_\_\_

BY: \_\_\_\_\_

NO. \_\_\_\_\_

DATE: \_\_\_\_\_

BY: \_\_\_\_\_

NO. \_\_\_\_\_

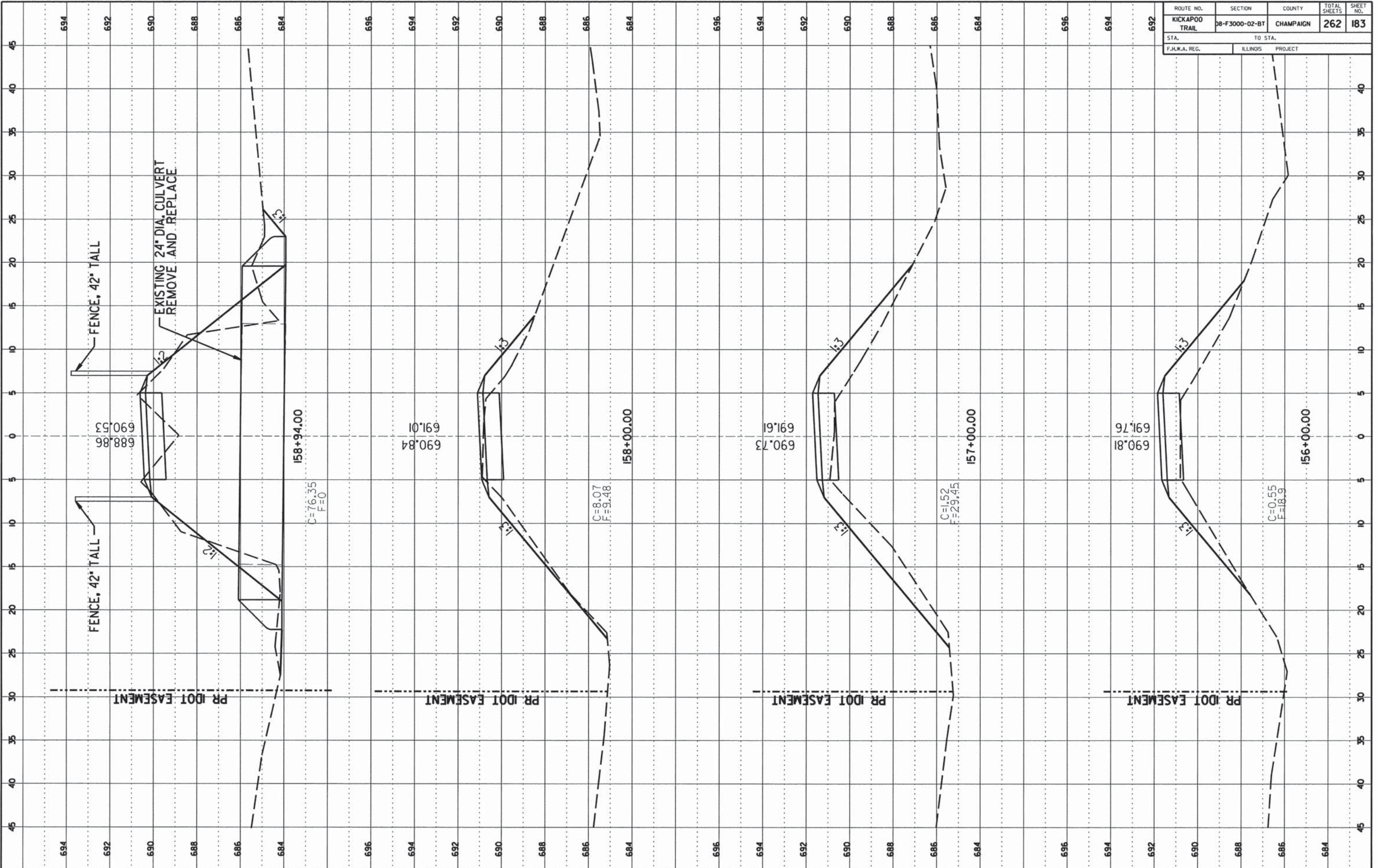

CONTRACT NO. 91520

ROUTE NO.	SECTION	COUNTY	TOTAL SHEETS	SHEET NO.
KICKAPOO TRAIL	08-F3000-02-BT	CHAMPAIGN	262	184
STA. TO STA.		ILLINOIS PROJECT		
F.H.W.A. REG.				

FINAL SURVEY  
 NO. \_\_\_\_\_  
 DATE \_\_\_\_\_

ORIGINAL SURVEY  
 NO. \_\_\_\_\_  
 DATE \_\_\_\_\_

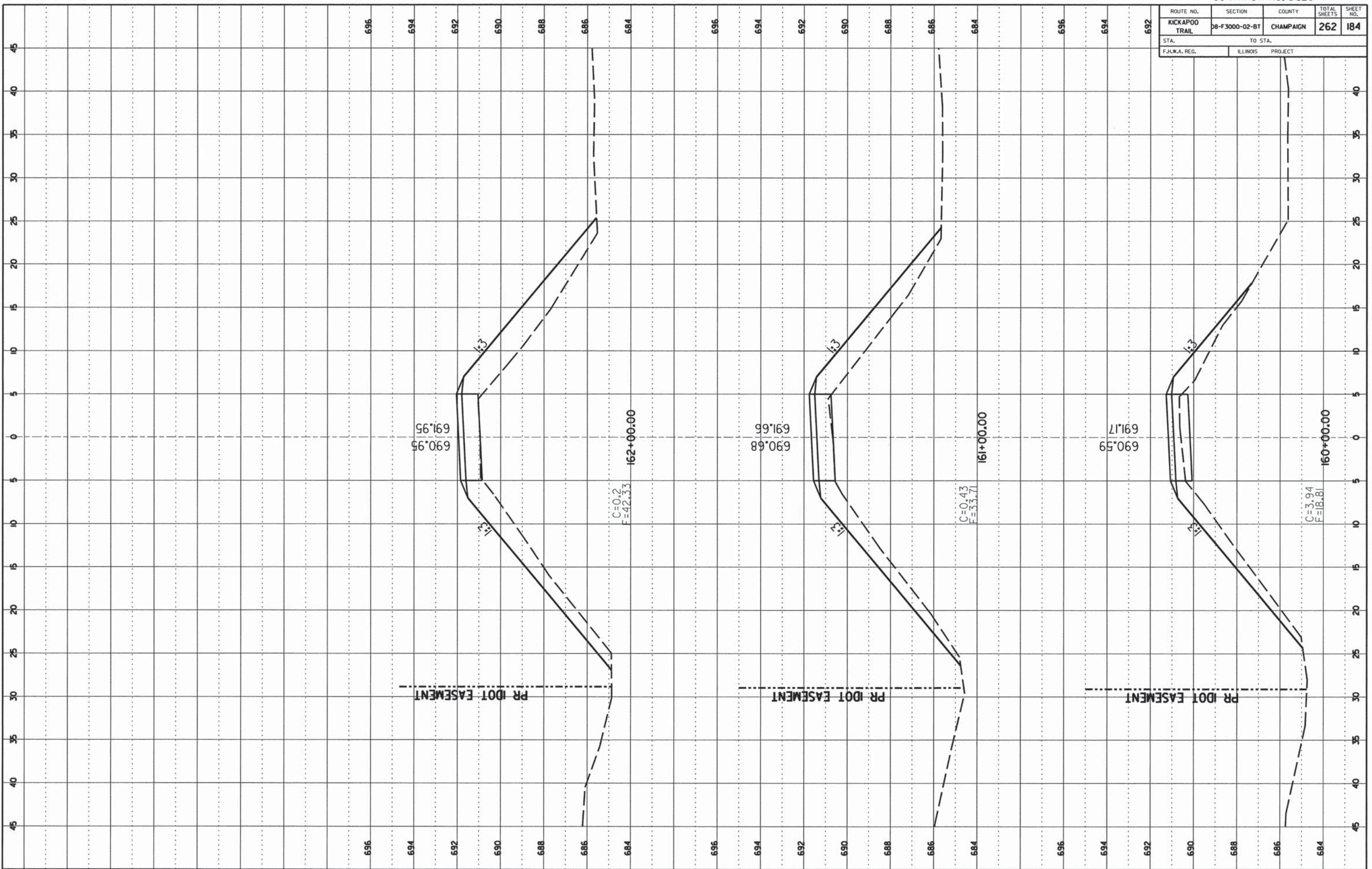

CCFPD KICKAPOO BIKE TRAIL

CHAMPAIGN COUNTY

SHEET 184 OF 262 SHEETS 13-620A

CONTRACT NO. 91520

ROUTE NO.	SECTION	COUNTY	TOTAL SHEETS	SHEET NO.
KICKAPOO TRAIL	08-F3000-02-BT	CHAMPAIGN	262	185
STA.	TO STA.			
F.H.W.A. REG.	ILLINOIS	PROJECT		

FINAL SURVEY  
 NO. \_\_\_\_\_  
 DATE \_\_\_\_\_

ORIGINAL SURVEY  
 NO. \_\_\_\_\_  
 DATE \_\_\_\_\_

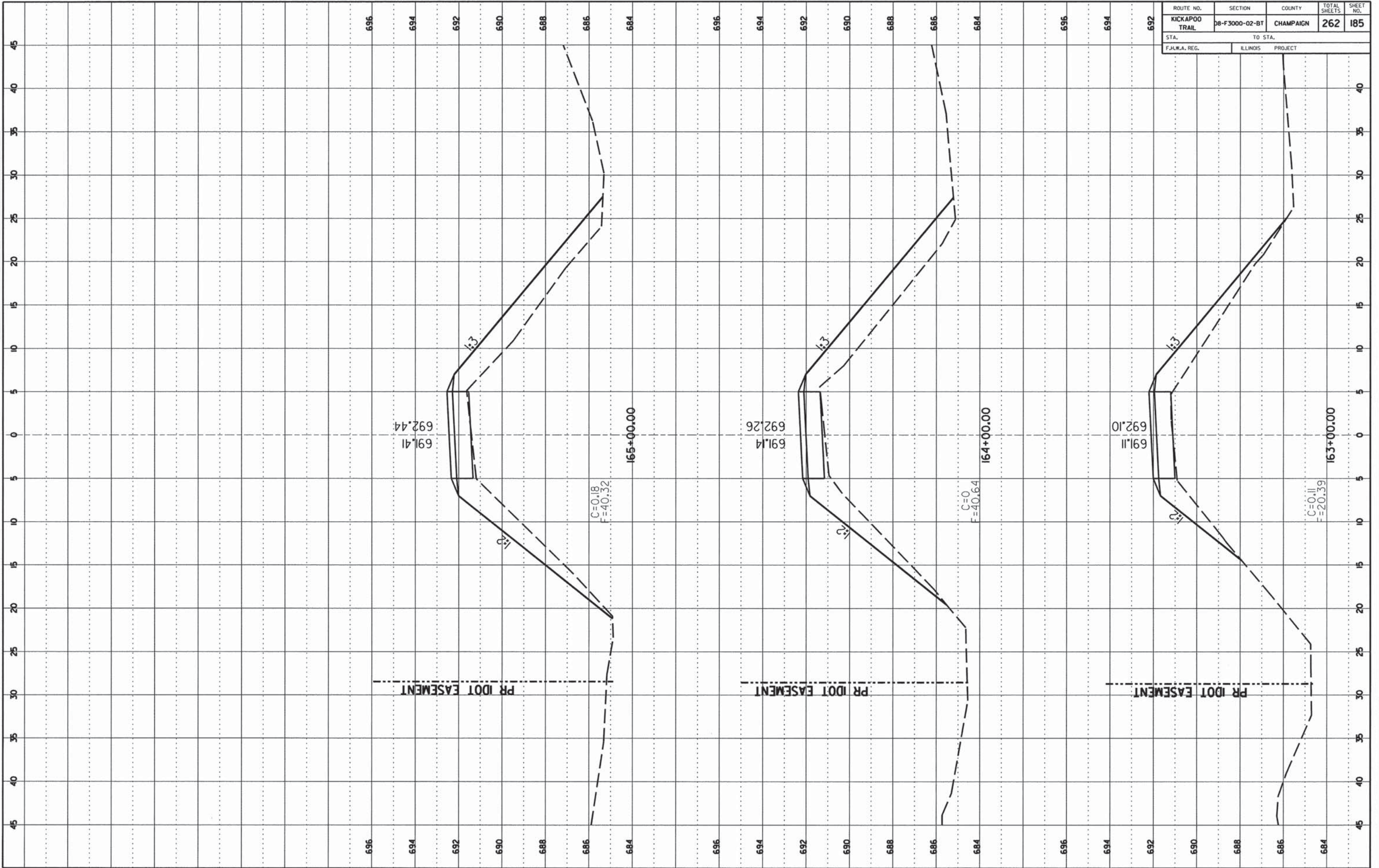

CCFPD KICKAPOO BIKE TRAIL

CHAMPAIGN COUNTY

SHEET 185 OF 262 SHEETS 13-620A

CONTRACT NO. 91520

ROUTE NO.	SECTION	COUNTY	TOTAL SHEETS	SHEET NO.
KICKAPOO TRAIL	08-F3000-02-BT	CHAMPAIGN	262	186
STA.	TO STA.			
F.H.W.A. REG.	ILLINOIS	PROJECT		

FINAL SURVEY  
 NO. \_\_\_\_\_  
 DATE \_\_\_\_\_  
 BY \_\_\_\_\_  
 SUPERVISOR \_\_\_\_\_  
 PLATTER \_\_\_\_\_  
 TEMPLATE \_\_\_\_\_  
 CHECKER \_\_\_\_\_

ORIGINAL SURVEY  
 NO. \_\_\_\_\_  
 DATE \_\_\_\_\_  
 BY \_\_\_\_\_  
 SUPERVISOR \_\_\_\_\_  
 PLATTER \_\_\_\_\_  
 TEMPLATE \_\_\_\_\_  
 CHECKER \_\_\_\_\_

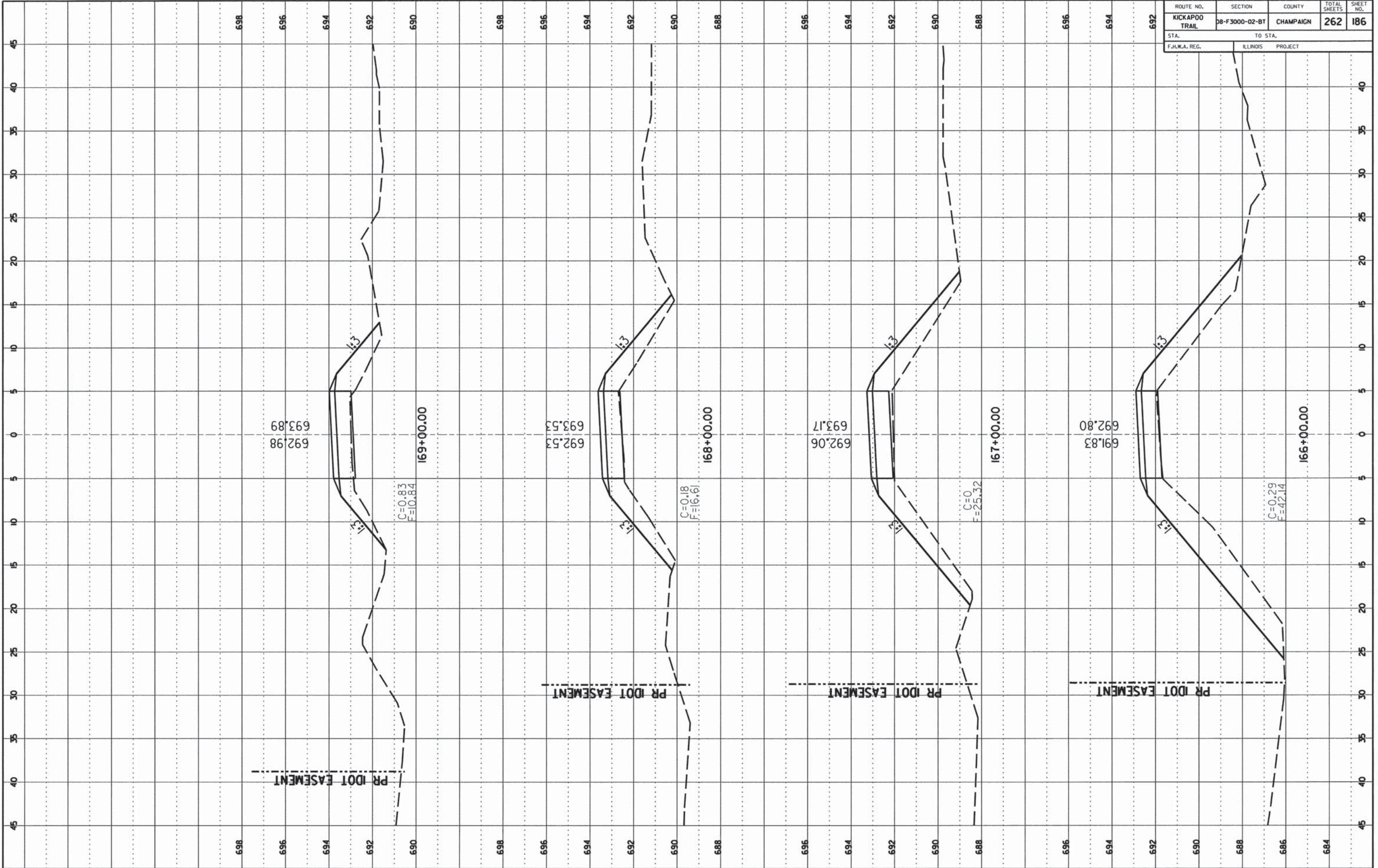

CONTRACT NO. 91520

ROUTE NO.	SECTION	COUNTY	TOTAL SHEETS	SHEET NO.
KICKAPOO TRAIL	08-F3000-02-BT	CHAMPAIGN	262	187
STA. F.H.W.A. REG.		TO STA. ILLINOIS PROJECT		

FINAL SURVEY

DATE: \_\_\_\_\_

BY: \_\_\_\_\_

NO. \_\_\_\_\_

AREA COVERED: \_\_\_\_\_

ORIGINAL SURVEY

DATE: \_\_\_\_\_

BY: \_\_\_\_\_

NO. \_\_\_\_\_

AREA COVERED: \_\_\_\_\_

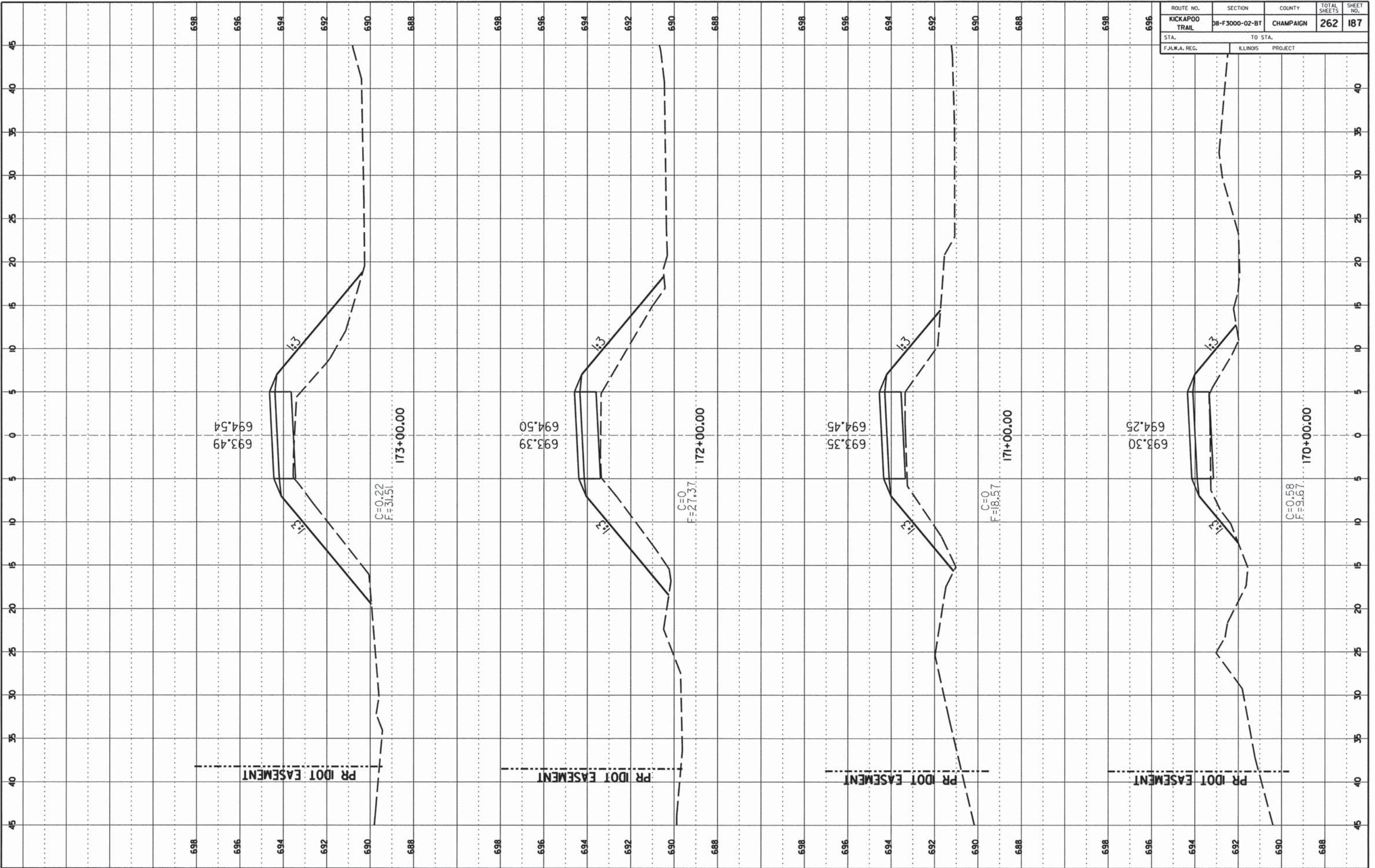

CONTRACT NO. 91520

ROUTE NO.	SECTION	COUNTY	TOTAL SHEETS	SHEET NO.
KICKAPOO TRAIL	08-F3000-02-BT	CHAMPAIGN	262	188
STA.	TO STA.			
F.H.W.A. REG.	ILLINOIS	PROJECT		

FINAL SURVEY

DATE	
BY	
NO.	
NO.	
NO.	
NO.	
NO.	
NO.	

ORIGINAL SURVEY

DATE	
BY	
NO.	
NO.	
NO.	
NO.	
NO.	
NO.	

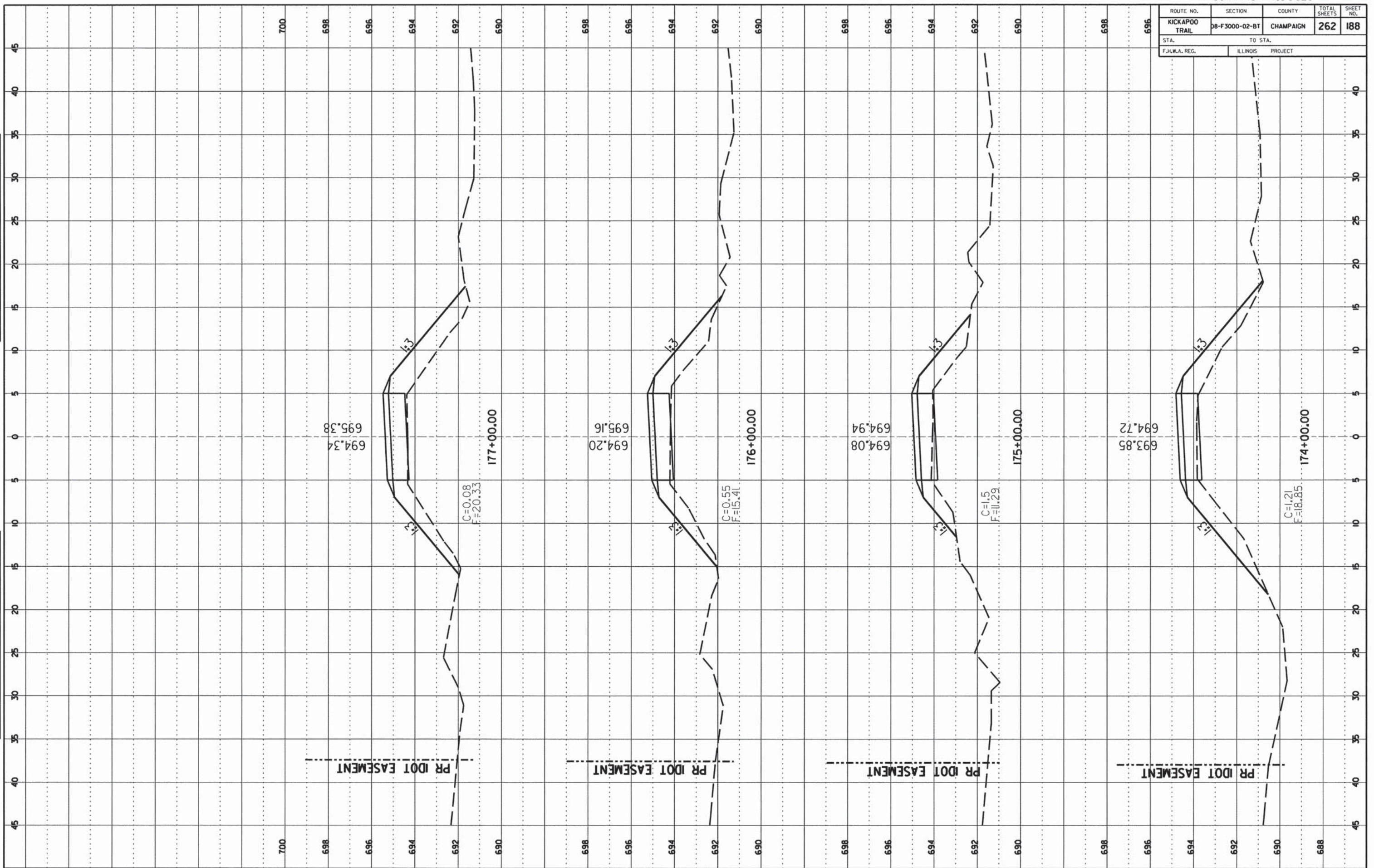

CONTRACT NO. 91520

ROUTE NO.	SECTION	COUNTY	TOTAL SHEETS	SHEET NO.
KICKAPOO TRAIL	D8-F3000-02-BT	CHAMPAIGN	262	189
STA.		TO STA.		
F.H.W.A. REG.		ILLINOIS PROJECT		

FINAL SURVEY	DIRECTOR	DATE
NOTE BOOK NO.	PLATTED BY	
	AREA CHECKED	

ORIGINAL SURVEY	DIRECTOR	DATE
NOTE BOOK NO.	PLATTED BY	
	AREA CHECKED	

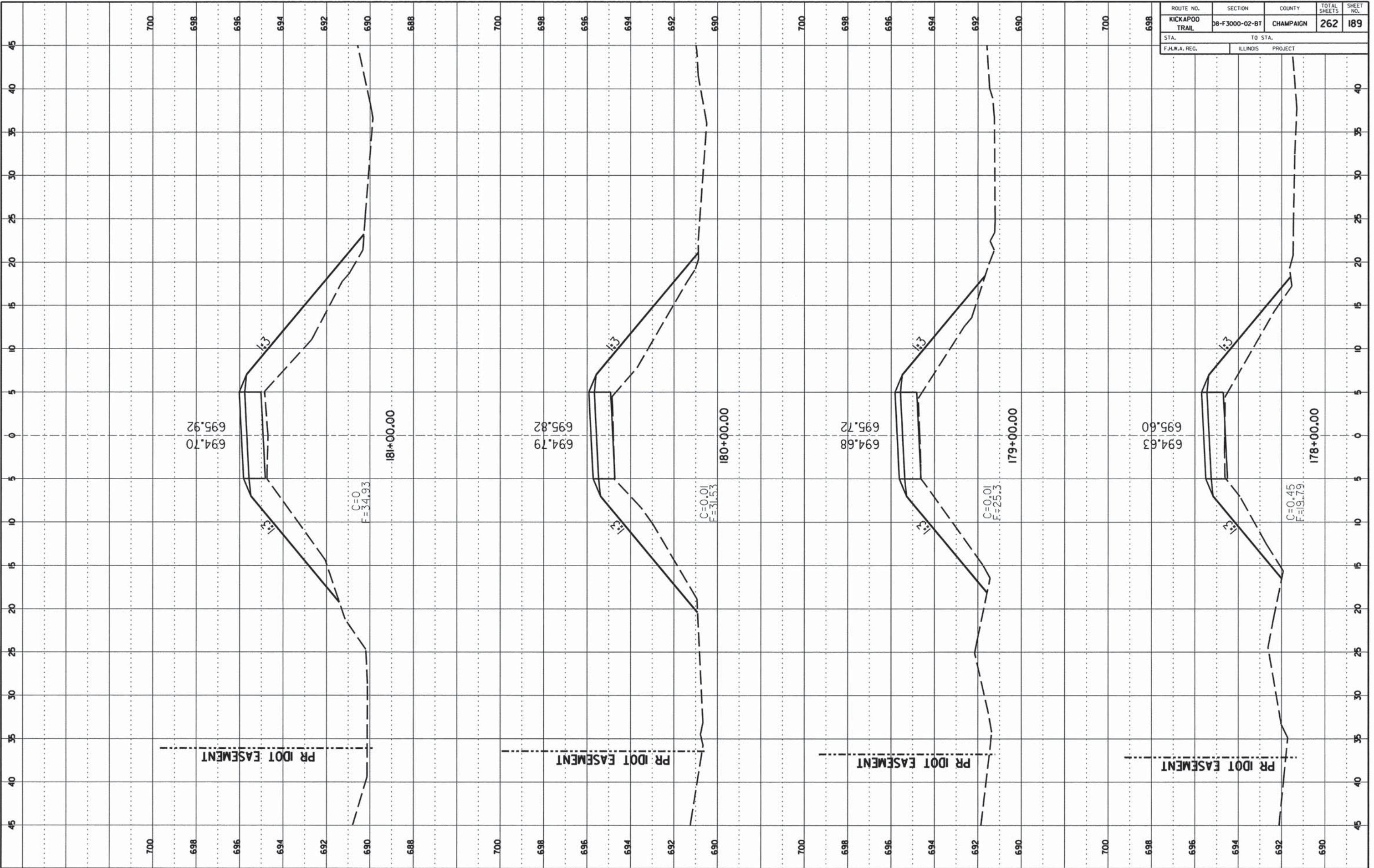

CCFPD KICKAPOO BIKE TRAIL CHAMPAIGN COUNTY



CONTRACT NO. 91520

ROUTE NO.	SECTION	COUNTY	TOTAL SHEETS	SHEET NO.
KICKAPOO TRAIL	08-F3000-02-BT	CHAMPAIGN	262	190
STA.		TO STA.		
F.H.W.A. REG.		ILLINOIS PROJECT		

FINAL SURVEY

DATE: \_\_\_\_\_ BY: \_\_\_\_\_

NO. \_\_\_\_\_

APPROVED: \_\_\_\_\_

DATE: \_\_\_\_\_ BY: \_\_\_\_\_

NO. \_\_\_\_\_

APPROVED: \_\_\_\_\_

ORIGINAL SURVEY

DATE: \_\_\_\_\_ BY: \_\_\_\_\_

NO. \_\_\_\_\_

APPROVED: \_\_\_\_\_

DATE: \_\_\_\_\_ BY: \_\_\_\_\_

NO. \_\_\_\_\_

APPROVED: \_\_\_\_\_

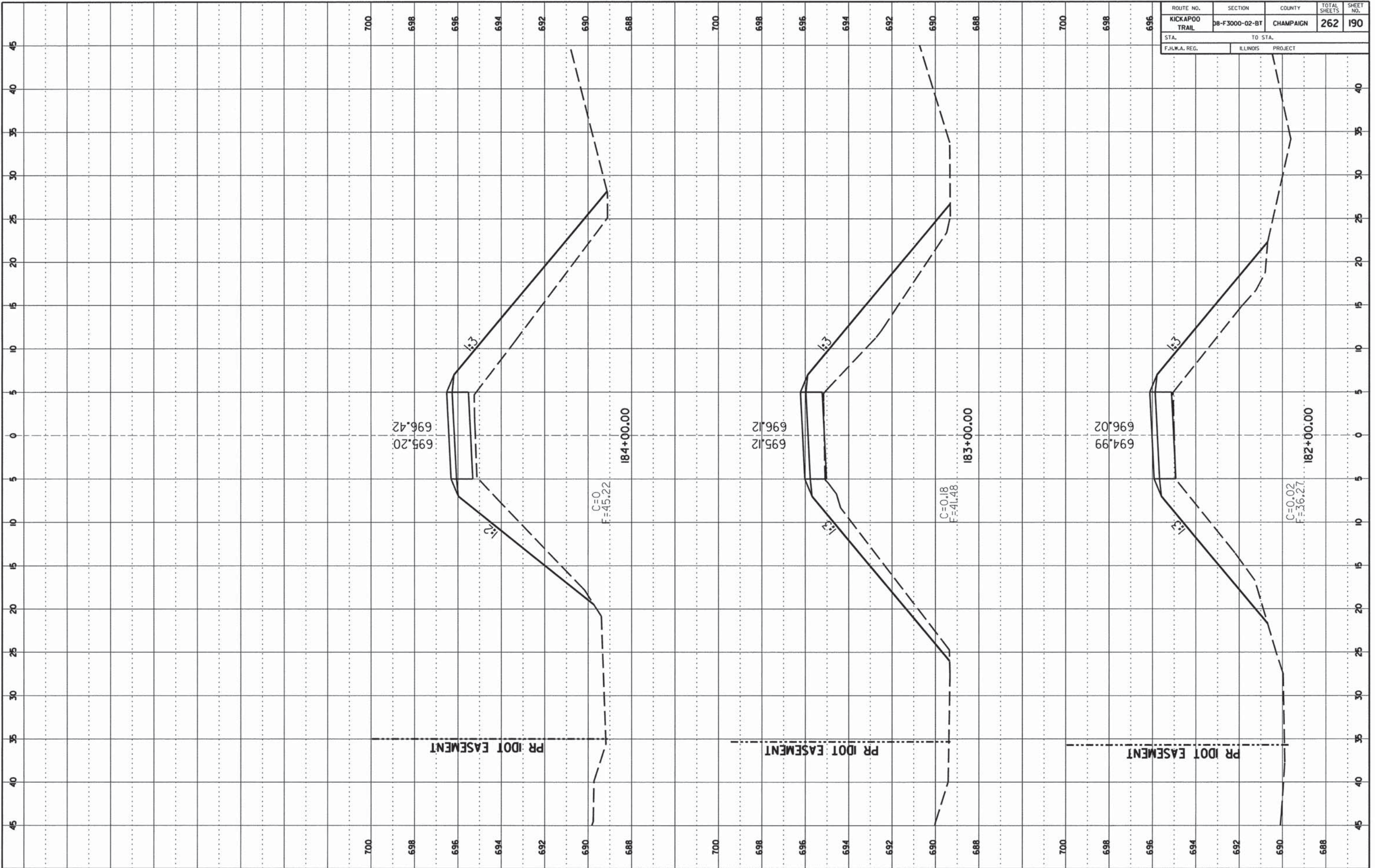

CONTRACT NO. 91520

ROUTE NO.	SECTION	COUNTY	TOTAL SHEETS	SHEET NO.
KICKAPOO TRAIL	08-F3000-02-BT	CHAMPAIGN	262	191
STA.		TO STA.		
F.H.W.A. REG.		ILLINOIS PROJECT		

NO.	DATE	BY

FINAL SURVEY  
 NO. \_\_\_\_\_ DATE \_\_\_\_\_  
 BY \_\_\_\_\_  
 CHECKED \_\_\_\_\_  
 DATE \_\_\_\_\_

NO.	DATE	BY

ORIGINAL SURVEY  
 NO. \_\_\_\_\_ DATE \_\_\_\_\_  
 BY \_\_\_\_\_  
 CHECKED \_\_\_\_\_  
 DATE \_\_\_\_\_

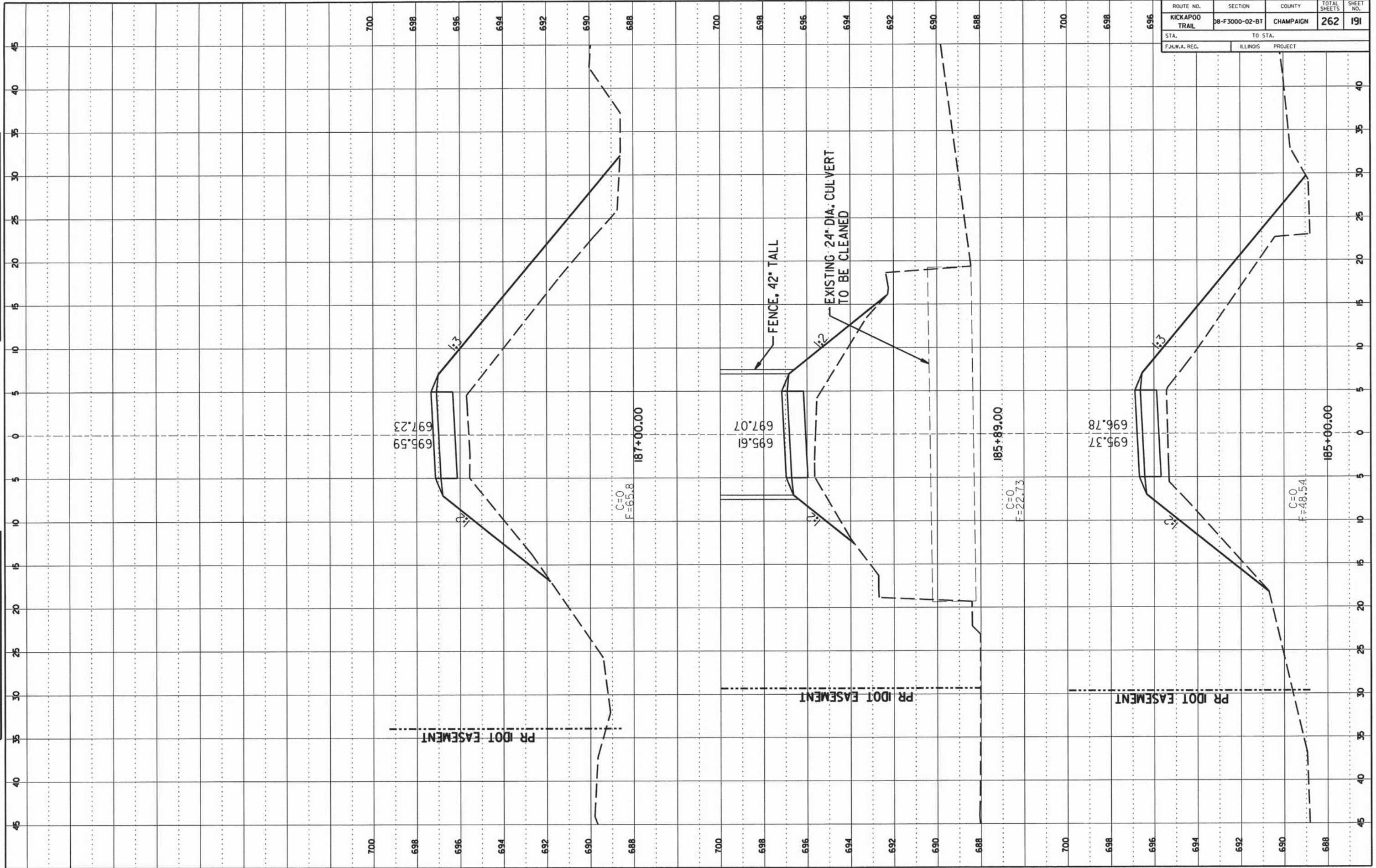

CCFPD KICKAPOO BIKE TRAIL

CHAMPAIGN COUNTY

SHEET 191 OF 262 SHEETS 13-620A

CONTRACT NO. 91520

ROUTE NO.	SECTION	COUNTY	TOTAL SHEETS	SHEET NO.
KICKAPOO TRAIL	08-F3000-02-BT	CHAMPAIGN	262	192
STA.		TO STA.		
F.H.W.A. REG.		ILLINOIS PROJECT		

FINAL SURVEY

DATE: \_\_\_\_\_ BY: \_\_\_\_\_

NO. \_\_\_\_\_

APPROVED BY: \_\_\_\_\_

DATE: \_\_\_\_\_

ORIGINAL SURVEY

DATE: \_\_\_\_\_ BY: \_\_\_\_\_

NO. \_\_\_\_\_

APPROVED BY: \_\_\_\_\_

DATE: \_\_\_\_\_

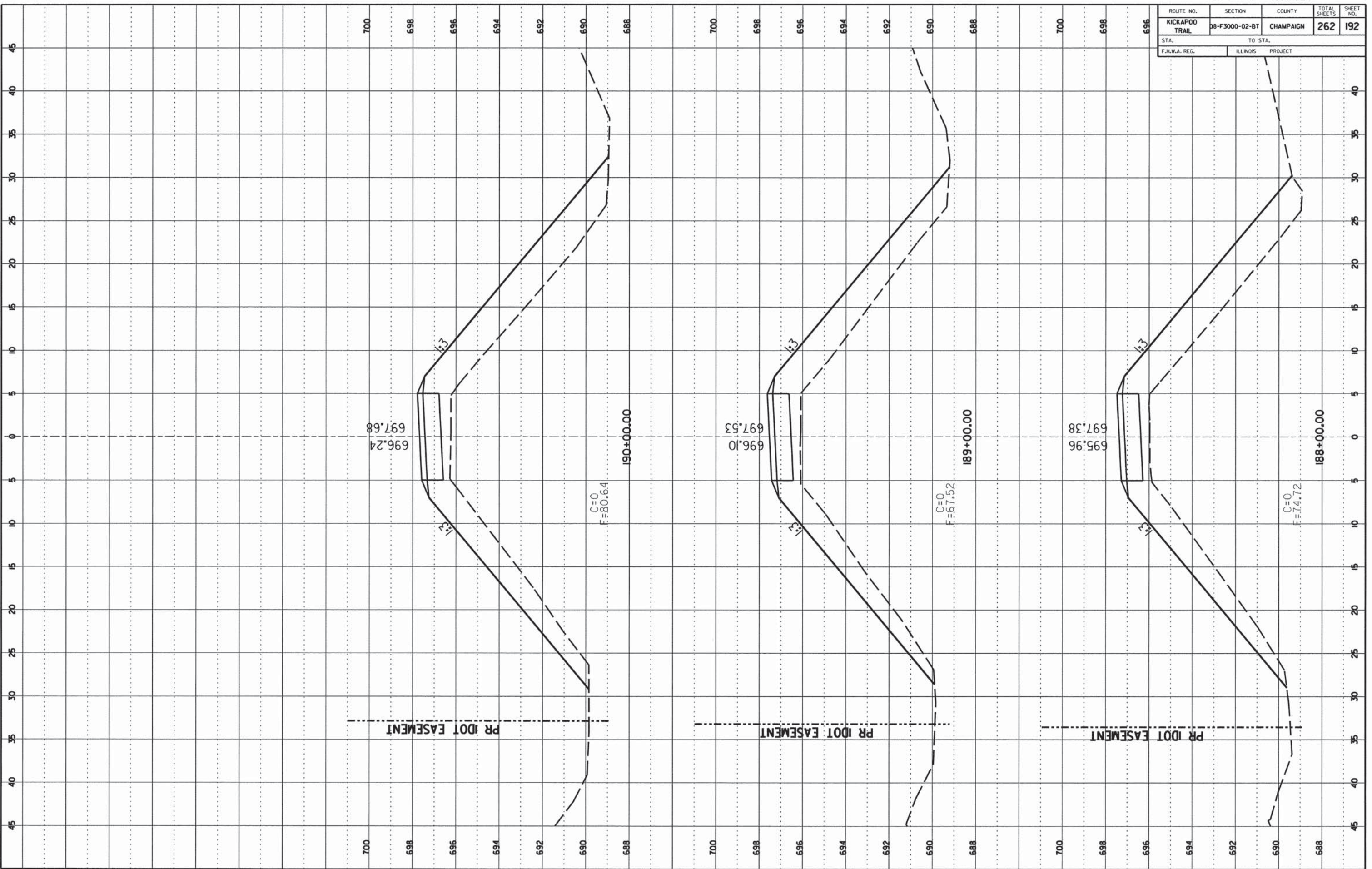

CCFPD KICKAPOO BIKE TRAIL

CHAMPAIGN COUNTY

CONTRACT NO. 91520

ROUTE NO.	SECTION	COUNTY	TOTAL SHEETS	SHEET NO.
KICKAPOO TRAIL	08-F3000-02-BT	CHAMPAIGN	262	193
STA.		TO STA.		
F.H.W.A. REG.		ILLINOIS PROJECT		

FINAL SURVEY  
 NO. \_\_\_\_\_  
 DATE \_\_\_\_\_

ORIGINAL SURVEY  
 NO. \_\_\_\_\_  
 DATE \_\_\_\_\_

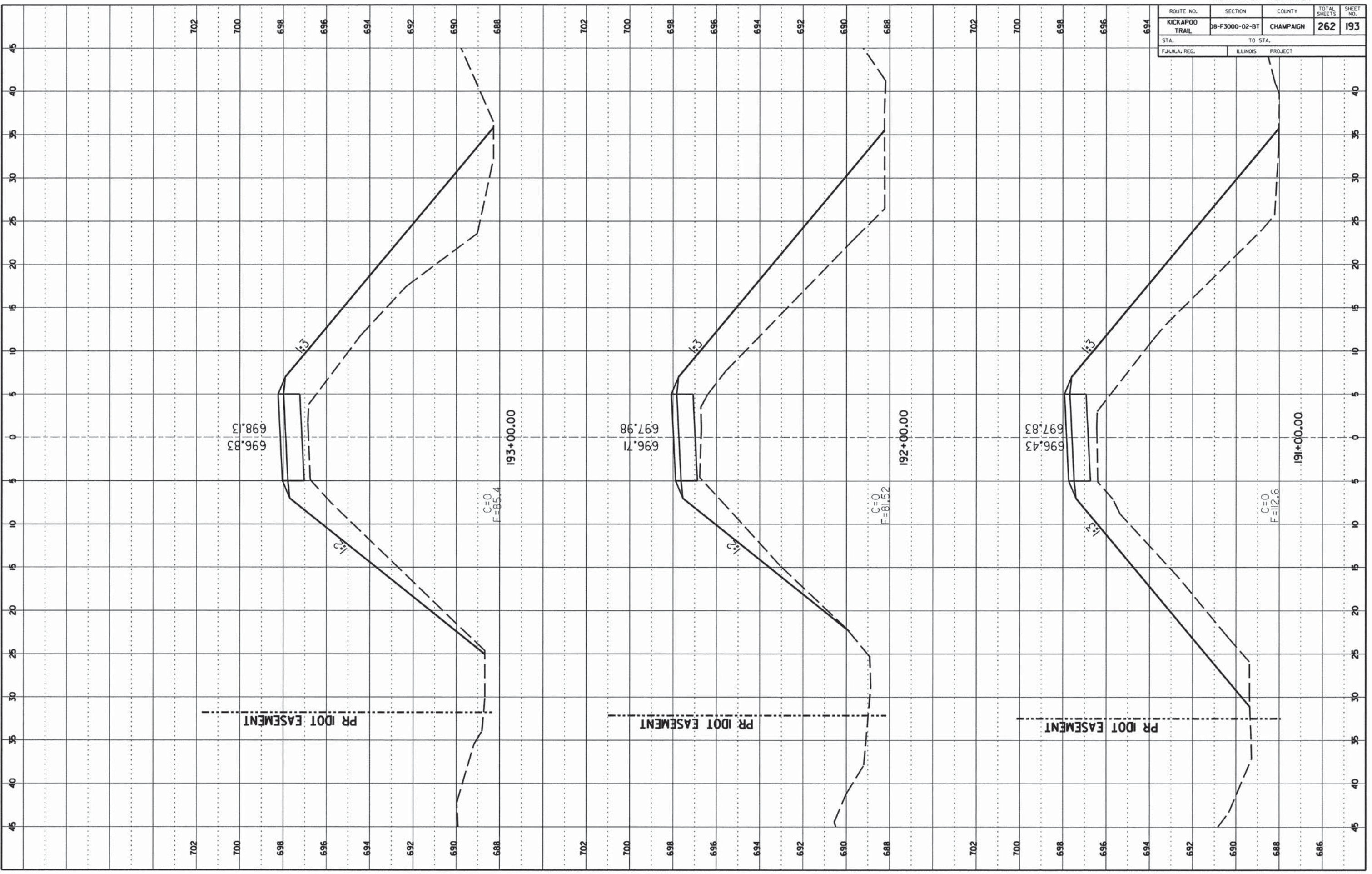

CONTRACT NO. 91520

ROUTE NO.	SECTION	COUNTY	TOTAL SHEETS	SHEET NO.
KICKAPOO TRAIL	DB-F3000-02-BT	CHAMPAIGN	262	194
STA.		TO STA.		
F.H.W.A. REG.		ILLINOIS PROJECT		

FINAL SURVEY  
 NO. \_\_\_\_\_  
 DATE \_\_\_\_\_

ORIGINAL SURVEY  
 NO. \_\_\_\_\_  
 DATE \_\_\_\_\_

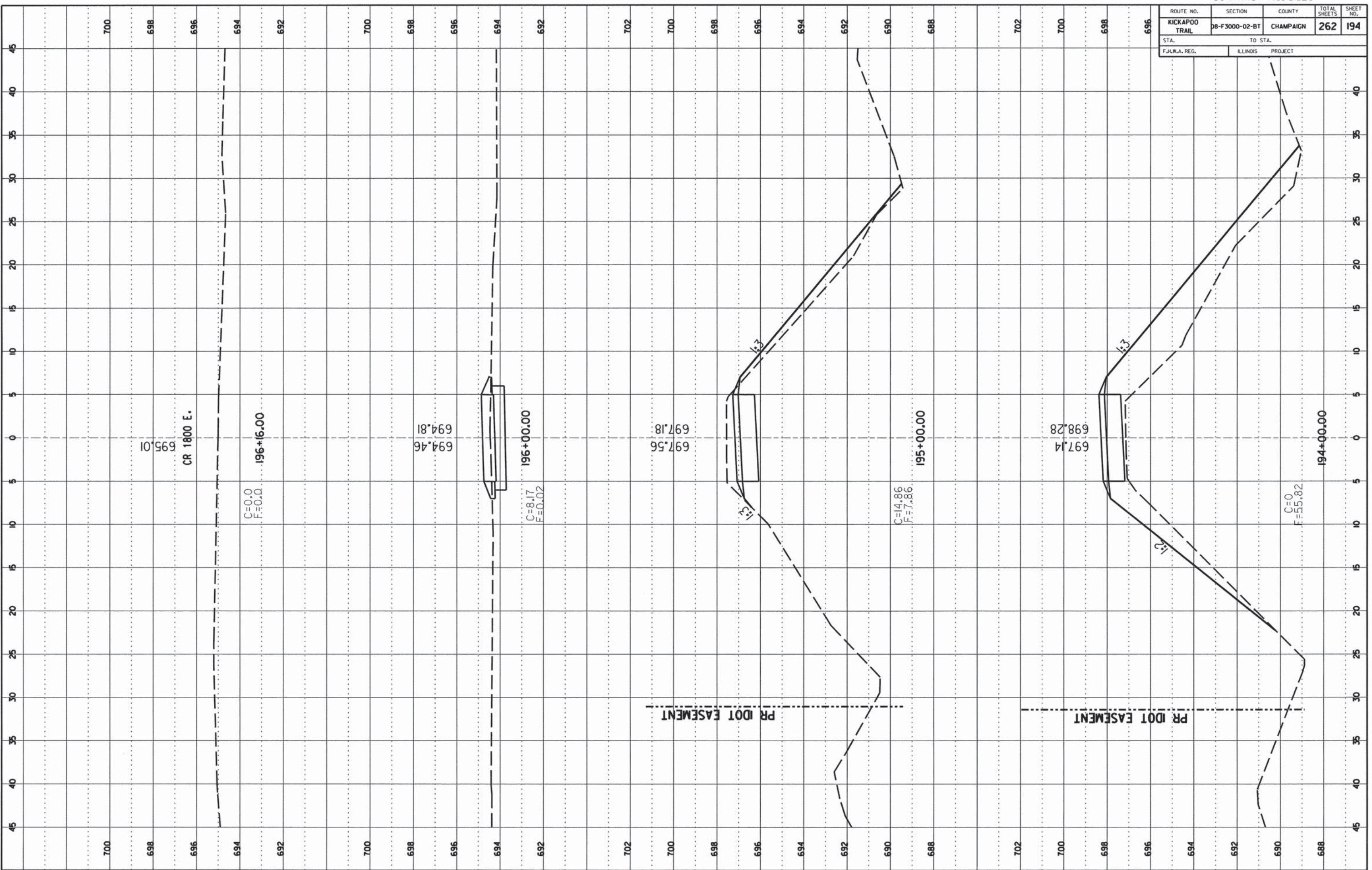

CONTRACT NO. 91520

ROUTE NO.	SECTION	COUNTY	TOTAL SHEETS	SHEET NO.
KICKAPOO TRAIL	08-F3000-02-BT	CHAMPAIGN	262	195
STA.	TO STA.			
F.H.W.A. REG.	ILLINOIS	PROJECT		

FINAL SURVEY

DATE: \_\_\_\_\_

NO. \_\_\_\_\_

NO. \_\_\_\_\_

NO. \_\_\_\_\_

NO. \_\_\_\_\_

NO. \_\_\_\_\_

ORIGINAL SURVEY

DATE: \_\_\_\_\_

NO. \_\_\_\_\_

NO. \_\_\_\_\_

NO. \_\_\_\_\_

NO. \_\_\_\_\_

NO. \_\_\_\_\_

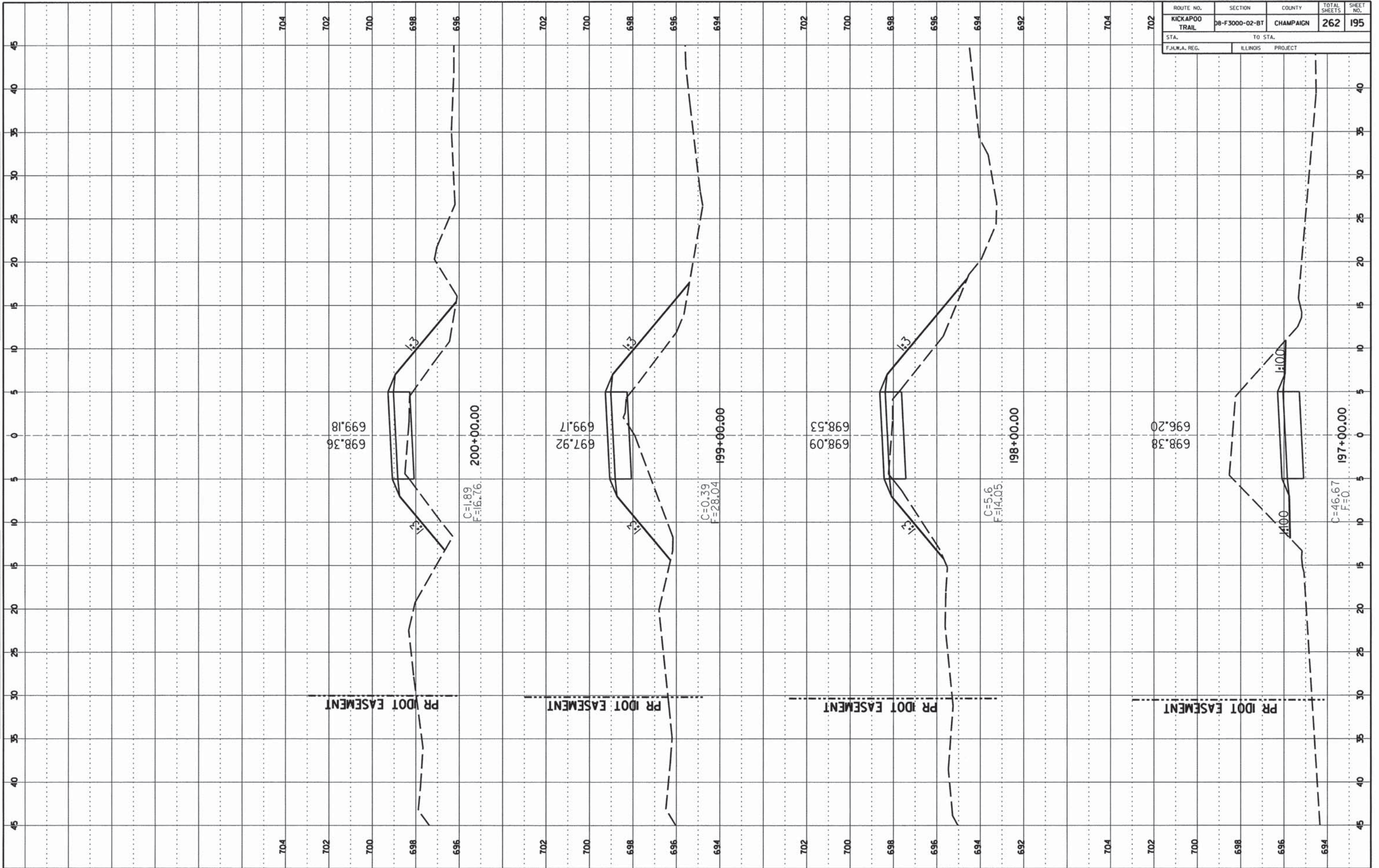

CONTRACT NO. 91520

ROUTE NO.	SECTION	COUNTY	TOTAL SHEETS	SHEET NO.
KICKAPOO TRAIL	08-F3000-02-BT	CHAMPAIGN	262	196
STA.	TO STA.			
F.H.W.A. REG.	ILLINOIS	PROJECT		

FINAL SURVEY  
 SURVEYED BY: \_\_\_\_\_  
 DATE: \_\_\_\_\_  
 NOTE BOOK NO.: \_\_\_\_\_  
 AREA COVERED: \_\_\_\_\_

ORIGINAL SURVEY  
 SURVEYED BY: \_\_\_\_\_  
 DATE: \_\_\_\_\_  
 NOTE BOOK NO.: \_\_\_\_\_  
 AREA COVERED: \_\_\_\_\_

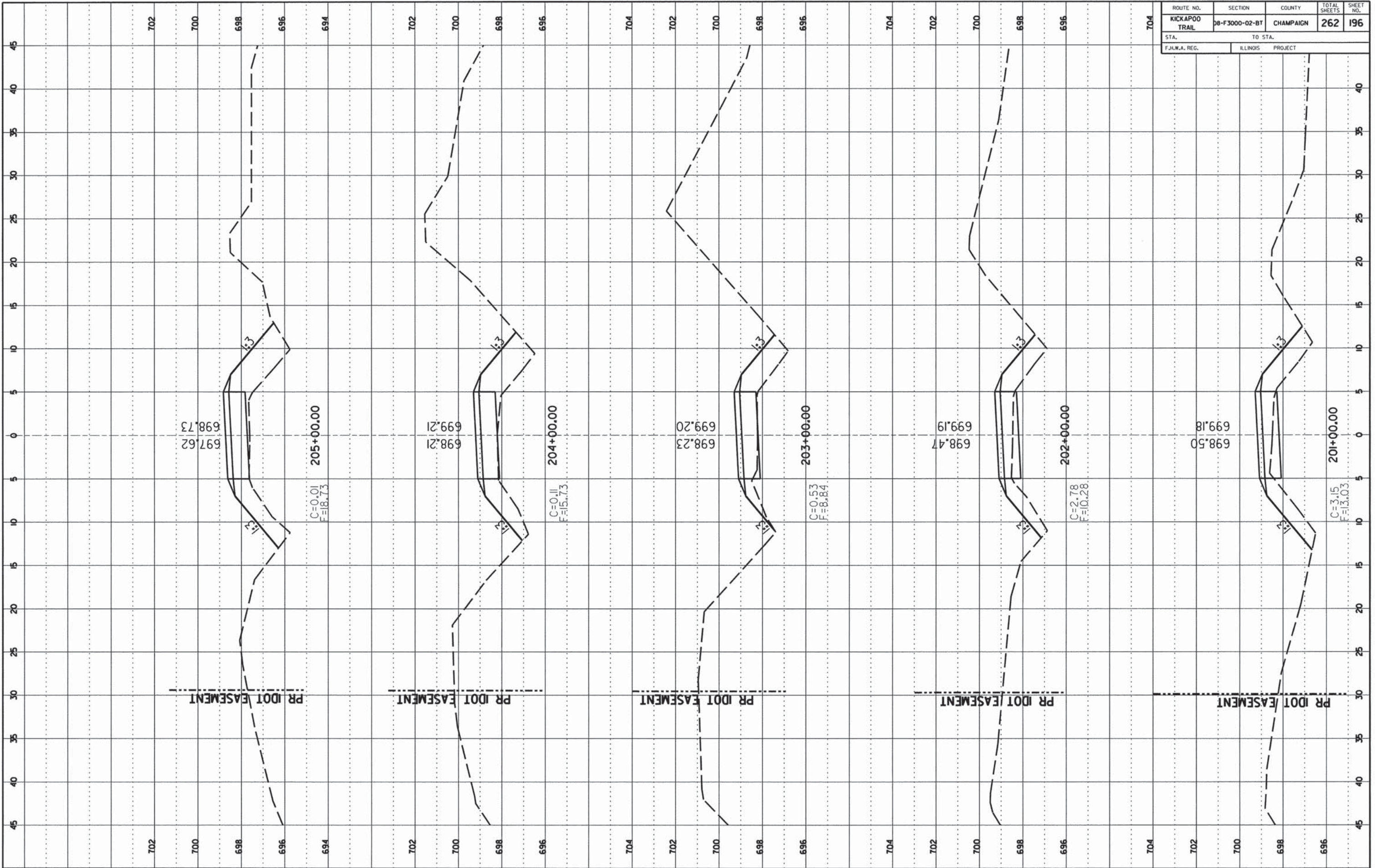

CCFPD KICKAPOO BIKE TRAIL

CHAMPAIGN COUNTY

CONTRACT NO. 91520

ROUTE NO.	SECTION	COUNTY	TOTAL SHEETS	SHEET NO.
KICKAPOO TRAIL	08-F3000-02-BT	CHAMPAIGN	262	197
STA.		TO STA.		
F.H.W.A. REG.		ILLINOIS PROJECT		

FINAL SURVEY

DATE	BY	PROJECT	PLATTED	MARKED	AREAS RECORDED

ORIGINAL SURVEY

DATE	BY	PROJECT	PLATTED	MARKED	AREAS RECORDED

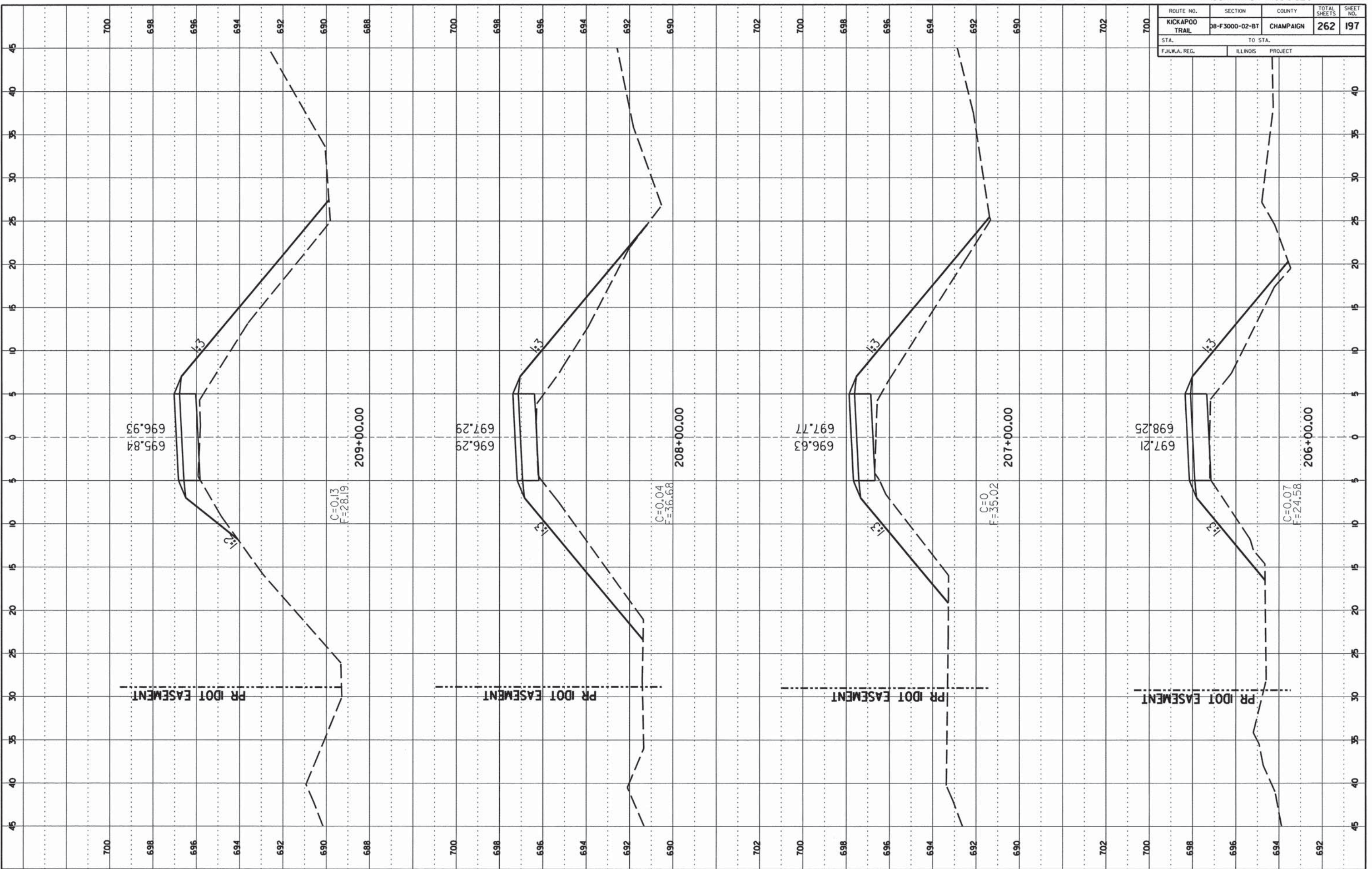



CONTRACT NO. 91520

ROUTE NO.	SECTION	COUNTY	TOTAL SHEETS	SHEET NO.
KICKAPOO TRAIL	08-F3000-02-BT	CHAMPAIGN	262	198
STA. F.H.W.A. REG.		TO STA. ILLINOIS PROJECT		

FINAL SURVEY  
 NO. \_\_\_\_\_  
 DATE \_\_\_\_\_

ORIGINAL SURVEY  
 NO. \_\_\_\_\_  
 DATE \_\_\_\_\_

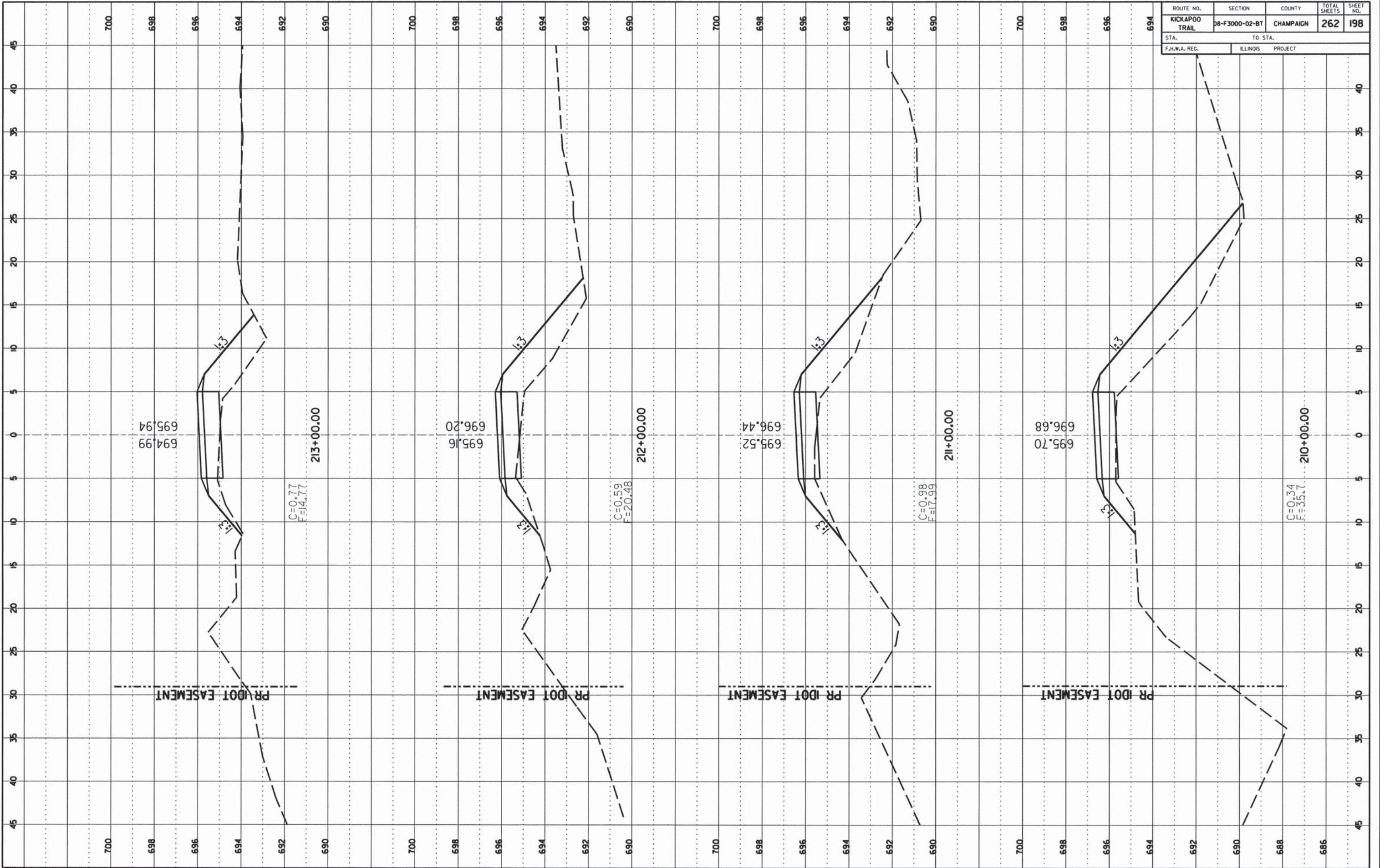

CCFPD KICKAPOO BIKE TRAIL

CHAMPAIGN COUNTY

CONTRACT NO. 91520

ROUTE NO.	SECTION	COUNTY	TOTAL SHEETS	SHEET NO.
KICKAPOO TRAIL	08-F3000-02-BT	CHAMPAIGN	262	199
STA.		TO STA.		
F.H.W.A. REG.		ILLINOIS PROJECT		

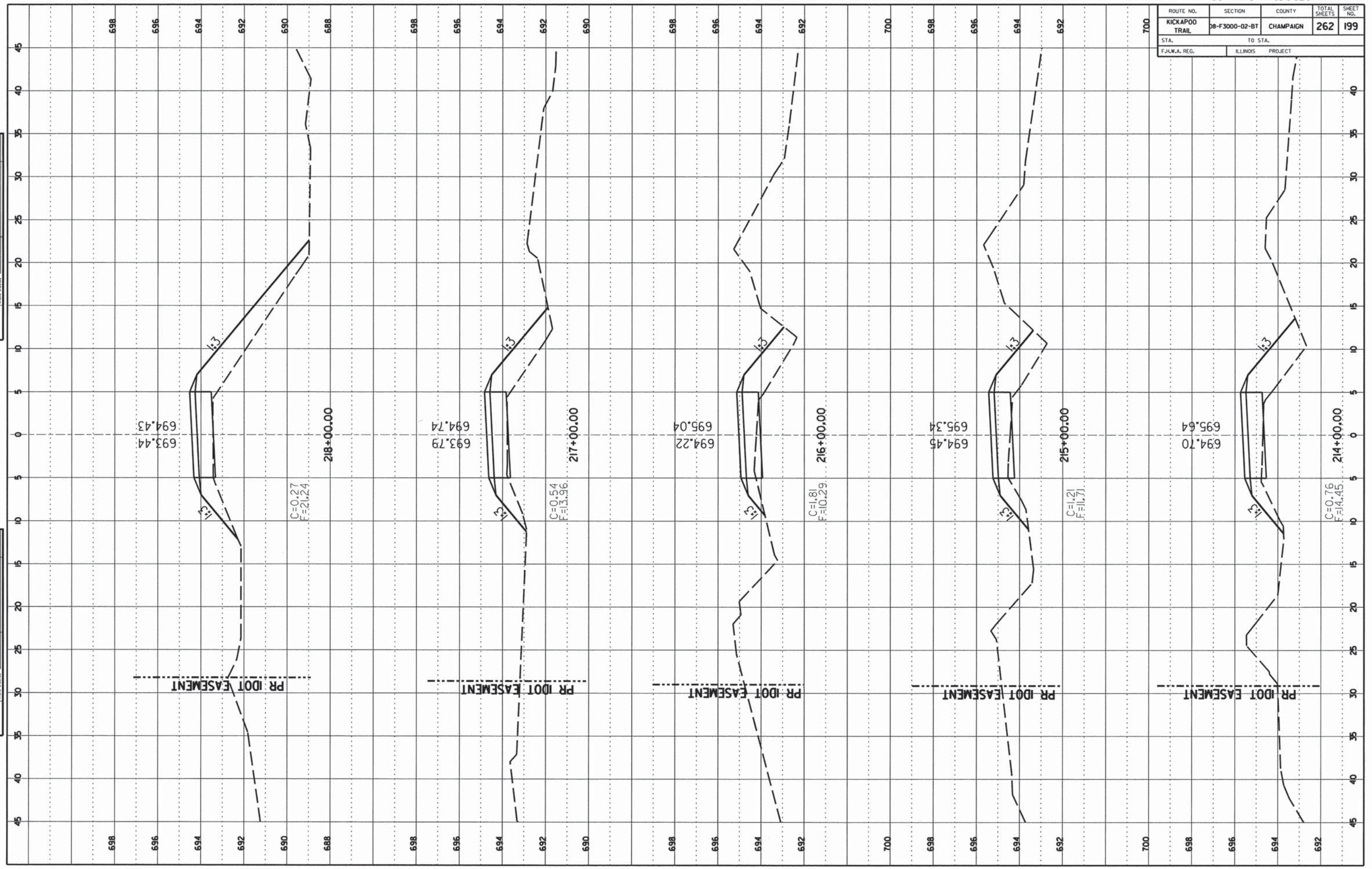

FINAL SURVEY  
 DATE: \_\_\_\_\_  
 BY: \_\_\_\_\_  
 CHECKED: \_\_\_\_\_  
 APPROVED: \_\_\_\_\_  
 TITLE: \_\_\_\_\_

ORIGINAL SURVEY  
 DATE: \_\_\_\_\_  
 BY: \_\_\_\_\_  
 CHECKED: \_\_\_\_\_  
 APPROVED: \_\_\_\_\_  
 TITLE: \_\_\_\_\_

CONTRACT NO. 91520

ROUTE NO.	SECTION	COUNTY	TOTAL SHEETS	SHEET NO.
KICKAPOO TRAIL	DB-F3000-02-BT	CHAMPAIGN	262	200
STA.	TO STA.			
F.H.W.A. REG.	ILLINOIS	PROJECT		

FINAL SURVEY

DATE	
BY	
REVISION	
NO.	

ORIGINAL SURVEY

DATE	
BY	
REVISION	
NO.	

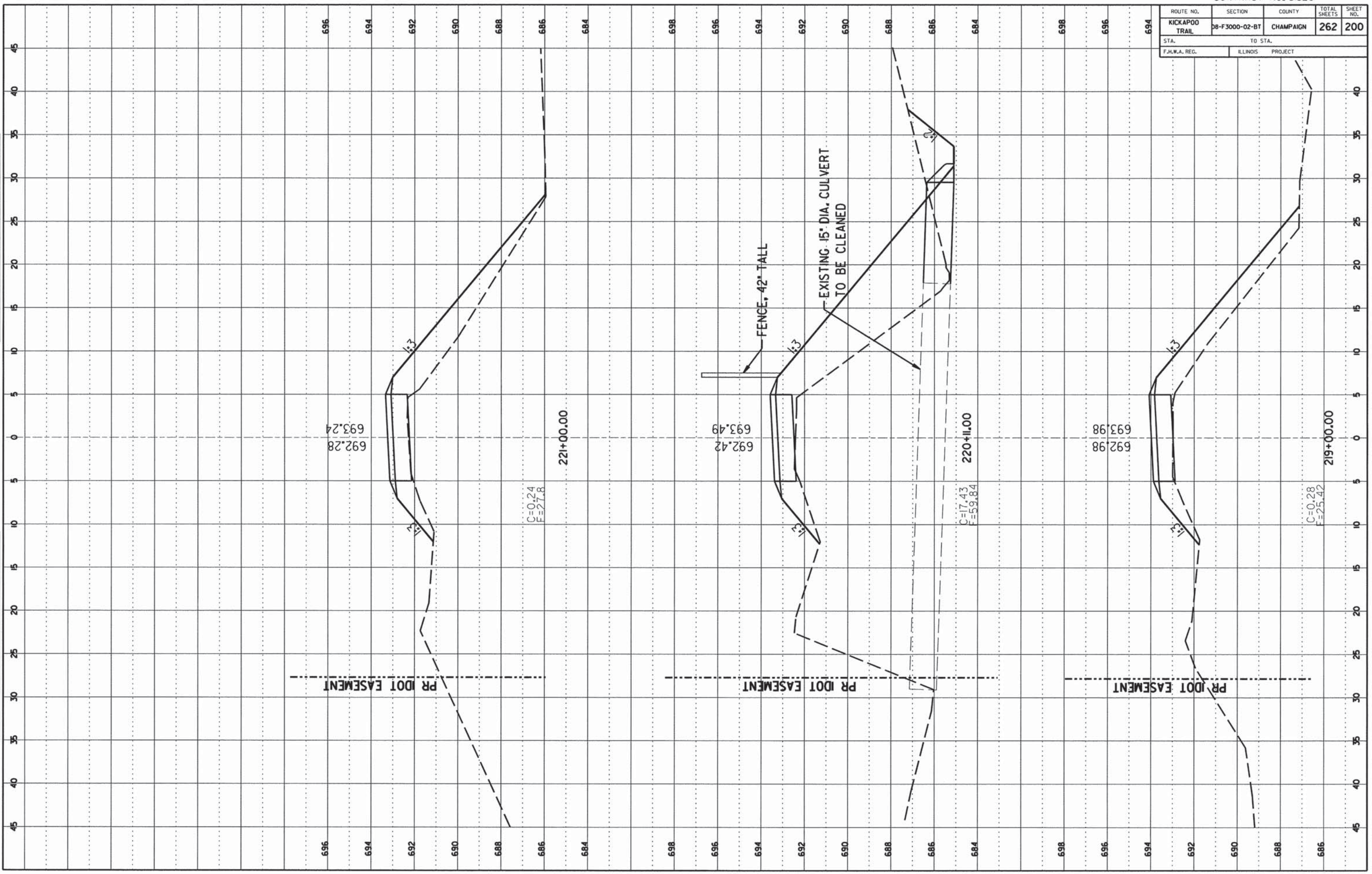

CCFPD KICKAPOO BIKE TRAIL

CHAMPAIGN COUNTY

SHEET 200 OF 262 SHEETS 13-620A

CONTRACT NO. 91520

ROUTE NO.	SECTION	COUNTY	TOTAL SHEETS	SHEET NO.
KICKAPOO TRAIL	08-F3000-02-BT	CHAMPAIGN	262	201
STA. TO STA.		ILLINOIS PROJECT		
F.H.W.A. REG.				

FINAL SURVEY  
 NO. \_\_\_\_\_  
 DATE \_\_\_\_\_

ORIGINAL SURVEY  
 NO. \_\_\_\_\_  
 DATE \_\_\_\_\_

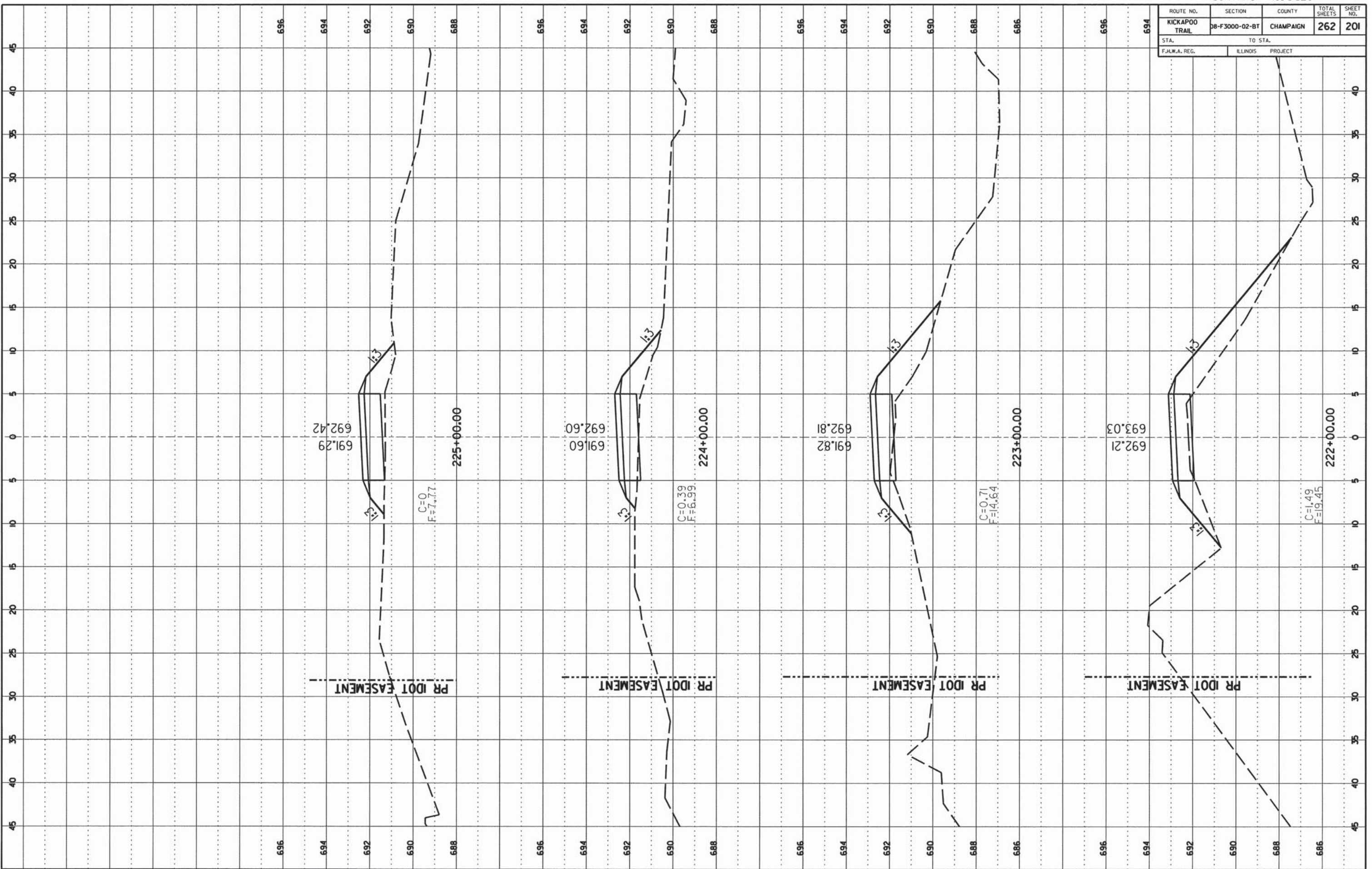

CONTRACT NO. 91520

ROUTE NO.	SECTION	COUNTY	TOTAL SHEETS	SHEET NO.
KICKAPOO TRAIL	DB-F3000-02-BT	CHAMPAIGN	262	202
STA.	TO STA.			
F.H.W.A. REG.	ILLINOIS	PROJECT		

FINAL SURVEY

DATE: \_\_\_\_\_

BY: \_\_\_\_\_

NO. \_\_\_\_\_

DATE: \_\_\_\_\_

BY: \_\_\_\_\_

NO. \_\_\_\_\_

ORIGINAL SURVEY

DATE: \_\_\_\_\_

BY: \_\_\_\_\_

NO. \_\_\_\_\_

DATE: \_\_\_\_\_

BY: \_\_\_\_\_

NO. \_\_\_\_\_

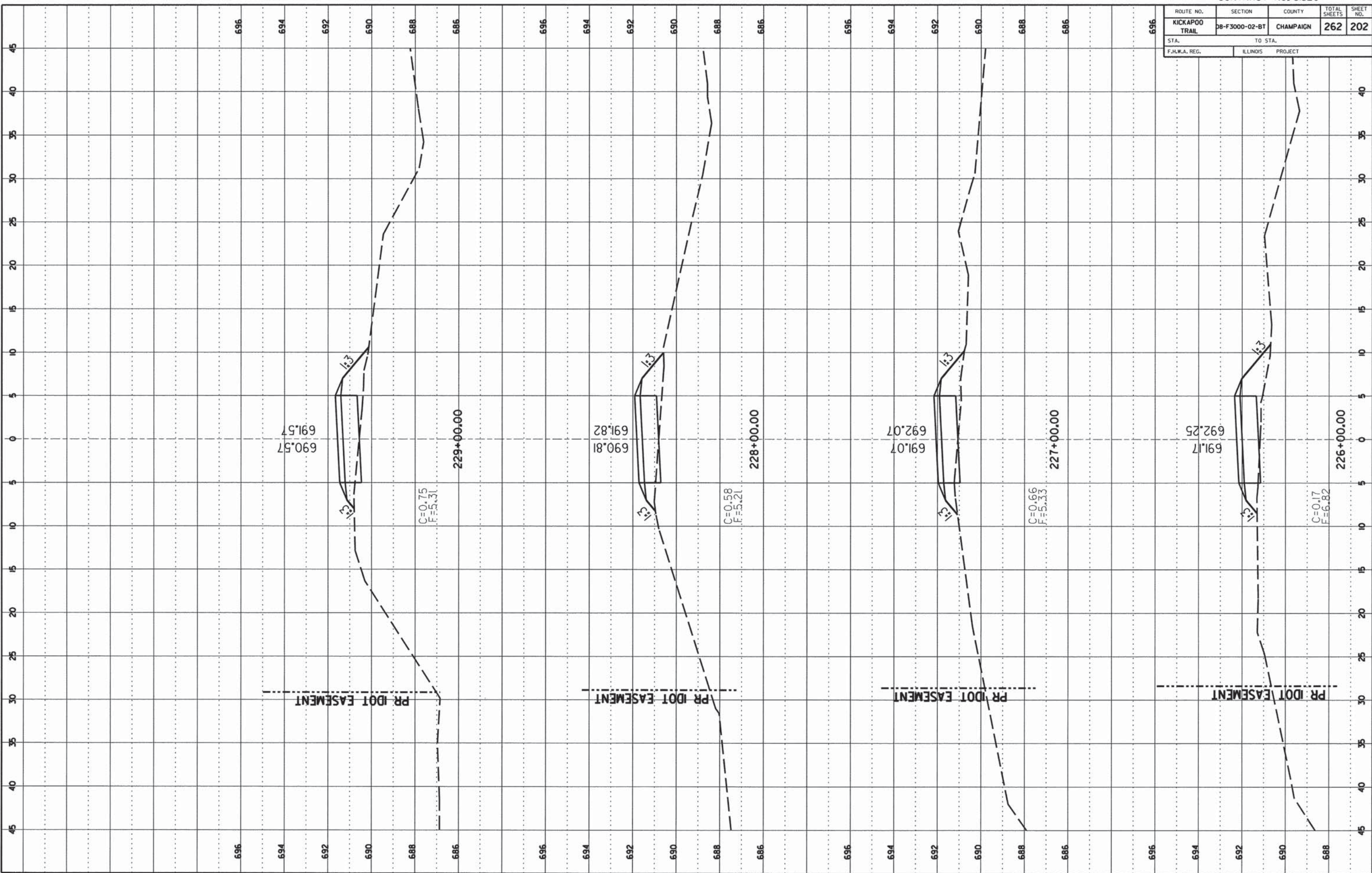

CCFPD KICKAPOO BIKE TRAIL CHAMPAIGN COUNTY

CONTRACT NO. 91520

ROUTE NO.	SECTION	COUNTY	TOTAL SHEETS	SHEET NO.
KICKAPOO TRAIL	08-F3000-02-BT	CHAMPAIGN	262	203
STA.	TO STA.			
F.H.W.A. REG.	ILLINOIS	PROJECT		

FINAL SURVEY	DATE
SURVEY NO.	
NOTE BOOK NO.	
DATE	
BY	
DATE	
BY	

ORIGINAL SURVEY	DATE
SURVEY NO.	
NOTE BOOK NO.	
DATE	
BY	
DATE	
BY	

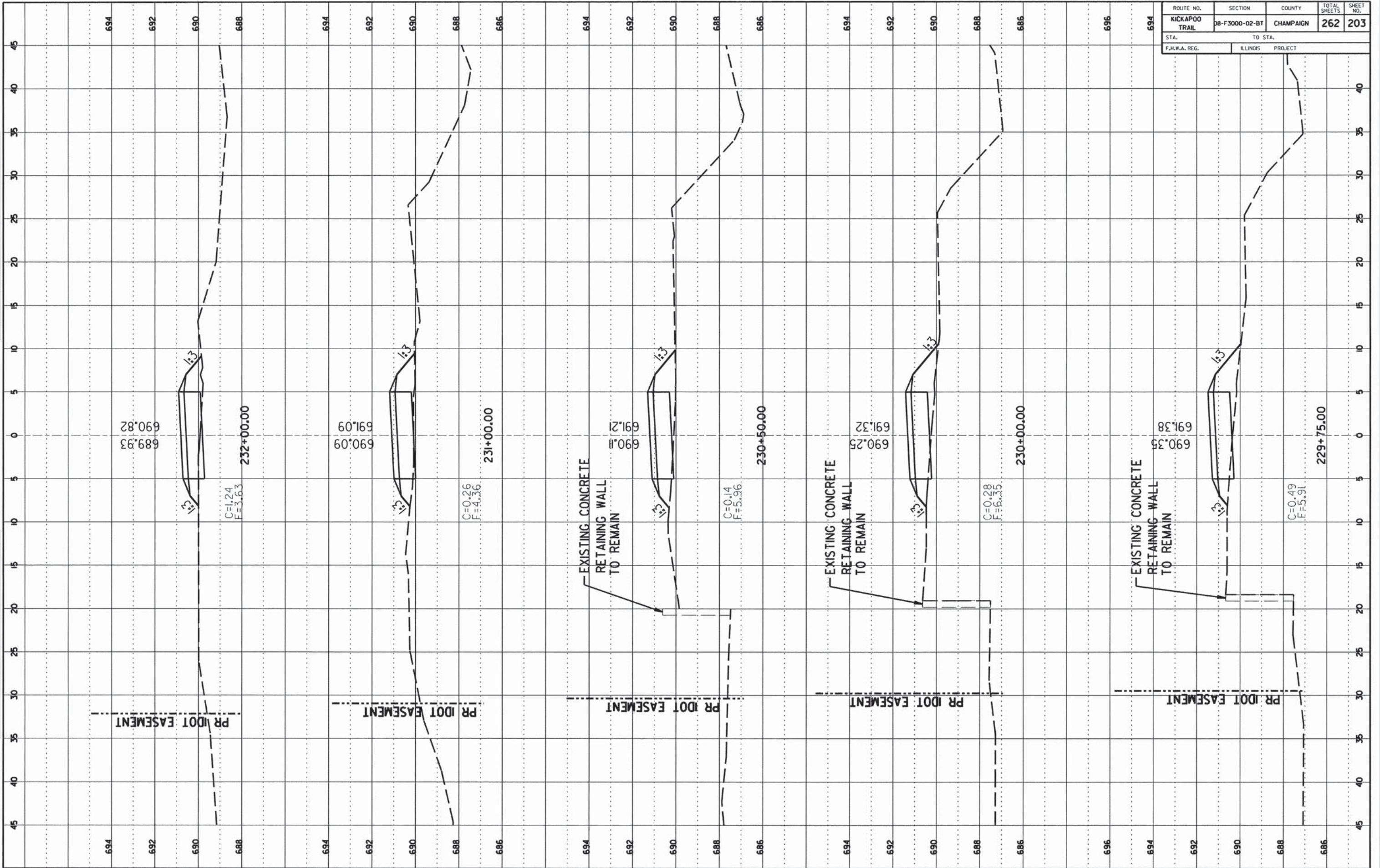

CONTRACT NO. 91520

ROUTE NO.	SECTION	COUNTY	TOTAL SHEETS	SHEET NO.
KICKAPOO TRAIL	08-F3000-02-BT	CHAMPAIGN	262	204
STA.		TO STA.		
F.H.W.A. REG.		ILLINOIS PROJECT		

DATE	BY

DATE	BY

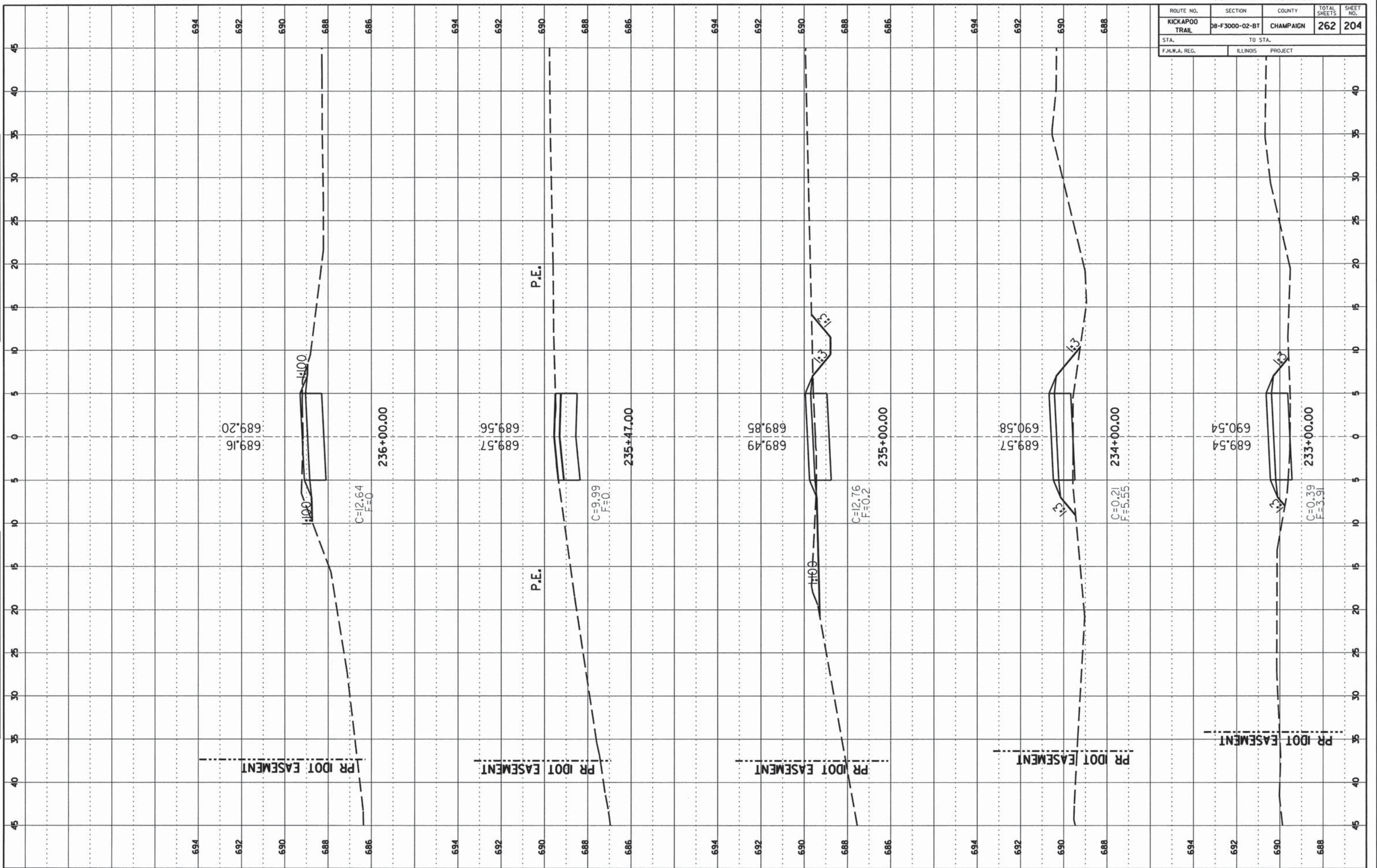

CONTRACT NO. 91520

ROUTE NO.	SECTION	COUNTY	TOTAL SHEETS	SHEET NO.
KICKAPOO TRAIL	08-F3000-02-BT	CHAMPAIGN	262	205
STA.	TO STA.			
F.H.W.A. REG.	ILLINOIS	PROJECT		

FINAL SURVEY

DATE: \_\_\_\_\_ BY: \_\_\_\_\_

NO. \_\_\_\_\_

APPROVED: \_\_\_\_\_

DATE: \_\_\_\_\_ BY: \_\_\_\_\_

NO. \_\_\_\_\_

APPROVED: \_\_\_\_\_

ORIGINAL SURVEY

DATE: \_\_\_\_\_ BY: \_\_\_\_\_

NO. \_\_\_\_\_

APPROVED: \_\_\_\_\_

DATE: \_\_\_\_\_ BY: \_\_\_\_\_

NO. \_\_\_\_\_

APPROVED: \_\_\_\_\_

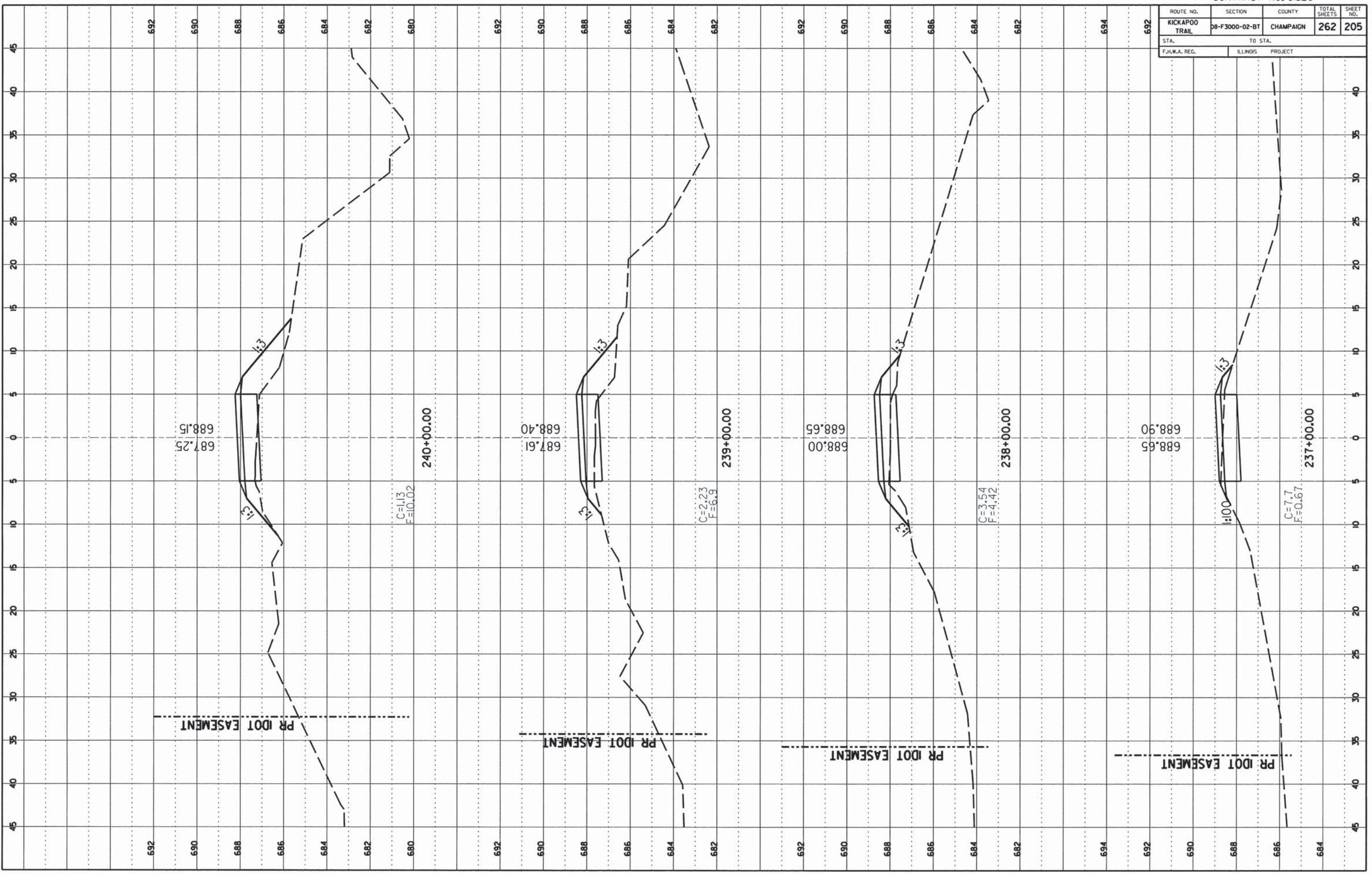

CCFPD KICKAPOO BIKE TRAIL CHAMPAIGN COUNTY



CONTRACT NO. 91520

ROUTE NO.	SECTION	COUNTY	TOTAL SHEETS	SHEET NO.
KICKAPOO TRAIL	DB-F3000-02-BT	CHAMPAIGN	262	206
STA. F.H.W.A. REG.		TO STA. ILLINOIS PROJECT		

FINAL SURVEY

NO.	DATE

ORIGINAL SURVEY

NO.	DATE

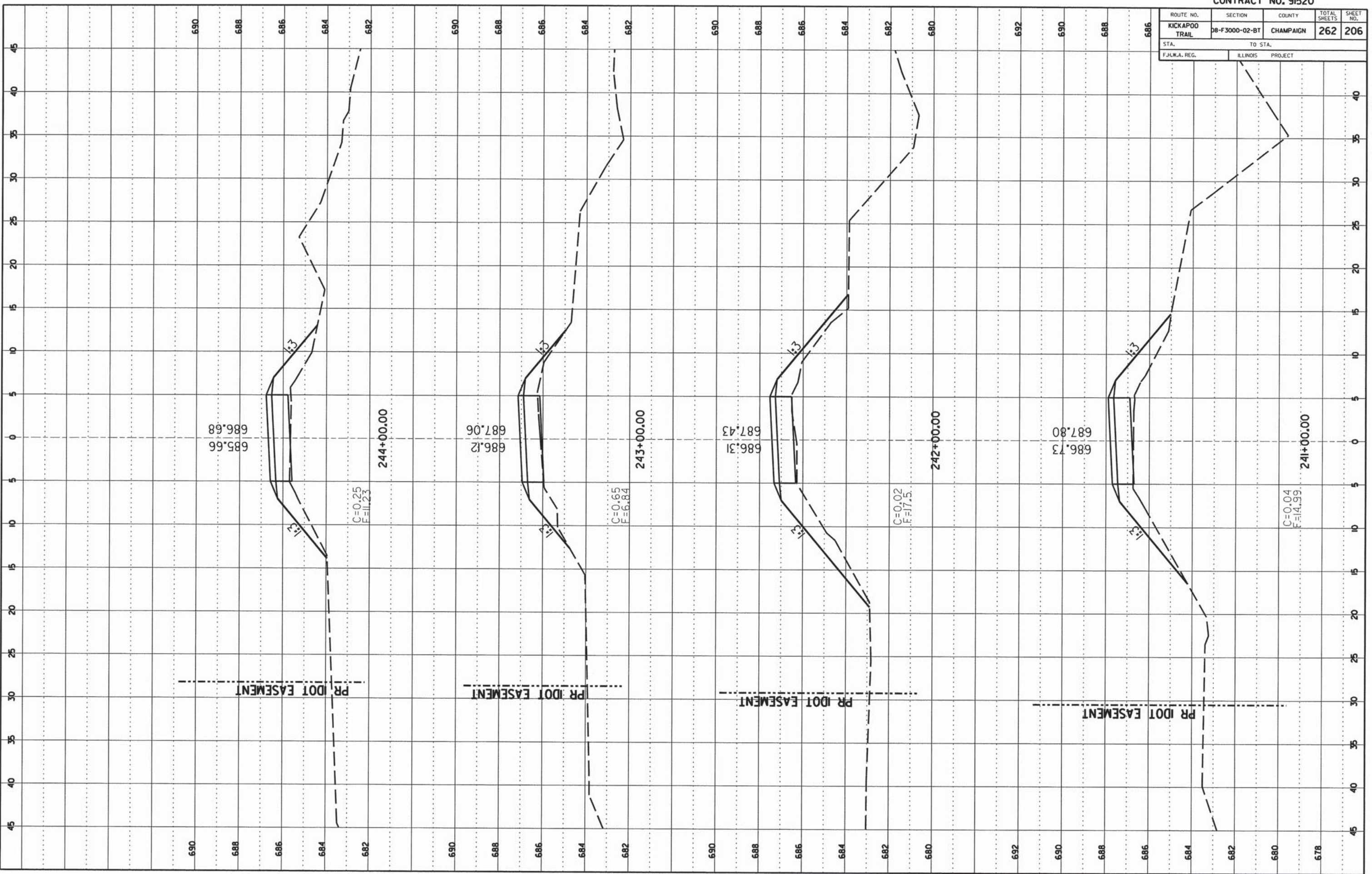

CCFPD KICKAPOO BIKE TRAIL CHAMPAIGN COUNTY

CONTRACT NO. 91520

ROUTE NO.	SECTION	COUNTY	TOTAL SHEETS	SHEET NO.
KICKAPOO TRAIL	08-F3000-02-BT	CHAMPAIGN	262	207
STA. _____ TO STA. _____		ILLINOIS PROJECT		
F.H.W.A. REG. _____		PROJECT _____		

NO.	DATE	BY	REVISION

NO.	DATE	BY	REVISION

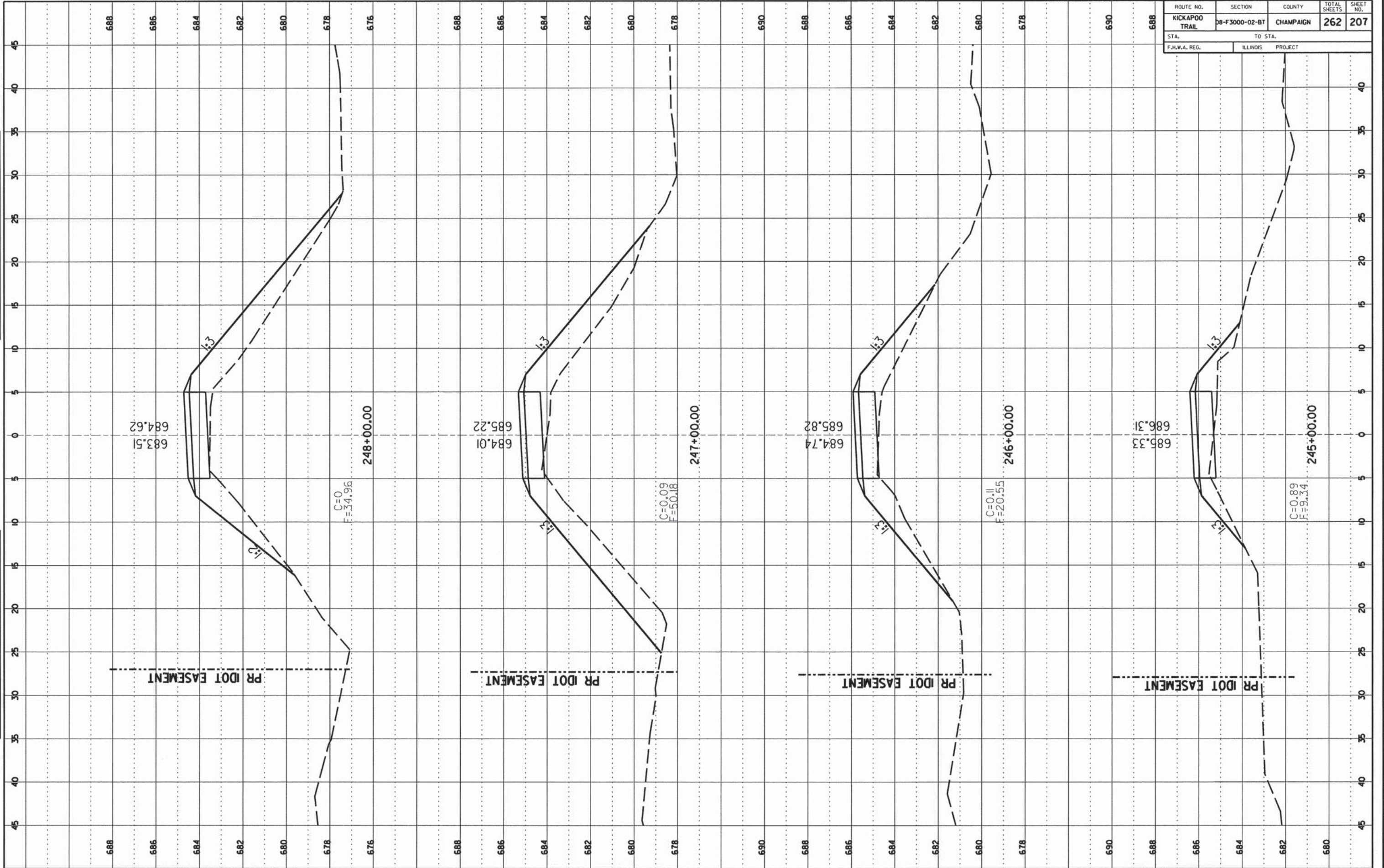

CCFPD KICKAPOO BIKE TRAIL CHAMPAIGN COUNTY

CONTRACT NO. 91520

ROUTE NO.	SECTION	COUNTY	TOTAL SHEETS	SHEET NO.
KICKAPOO TRAIL	08-F3000-02-BT	CHAMPAIGN	262	208
STA.	TO STA.			
F.H.W.A. REG.	ILLINOIS	PROJECT		

FINAL SURVEY  
 NO. \_\_\_\_\_  
 DATE \_\_\_\_\_

ORIGINAL SURVEY  
 NO. \_\_\_\_\_  
 DATE \_\_\_\_\_

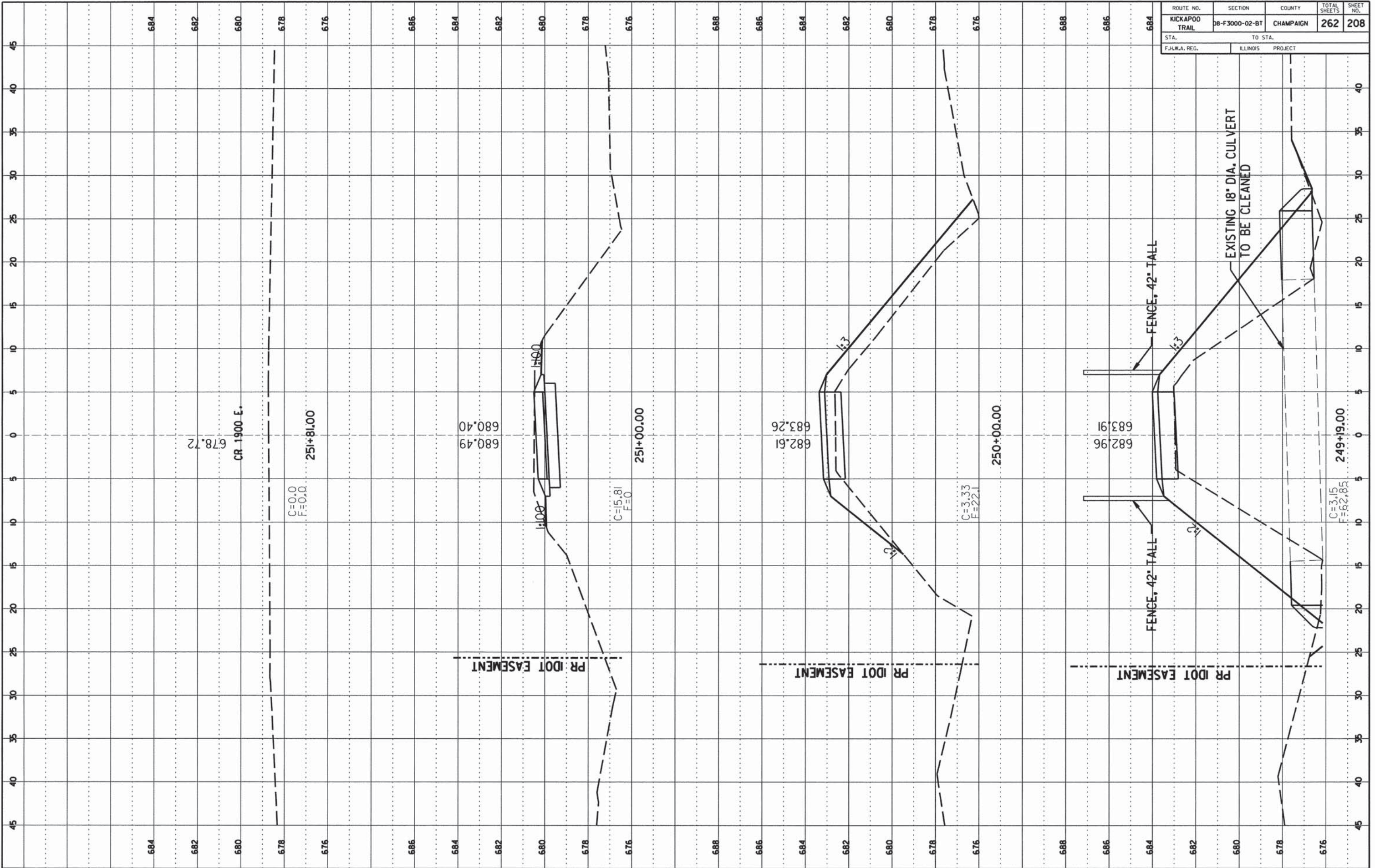

CONTRACT NO. 91520

ROUTE NO.	SECTION	COUNTY	TOTAL SHEETS	SHEET NO.
KICKAPOO TRAIL	DB-F3000-02-BT	CHAMPAIGN	262	209
STA.		TO STA.		
F.H.W.A. REG.		ILLINOIS PROJECT		

DATE	BY

FINAL SURVEY  
 NOTE BOOK NO. \_\_\_\_\_  
 AREAS DECIDED \_\_\_\_\_

DATE	BY

ORIGINAL SURVEY  
 NOTE BOOK NO. \_\_\_\_\_  
 AREAS DECIDED \_\_\_\_\_

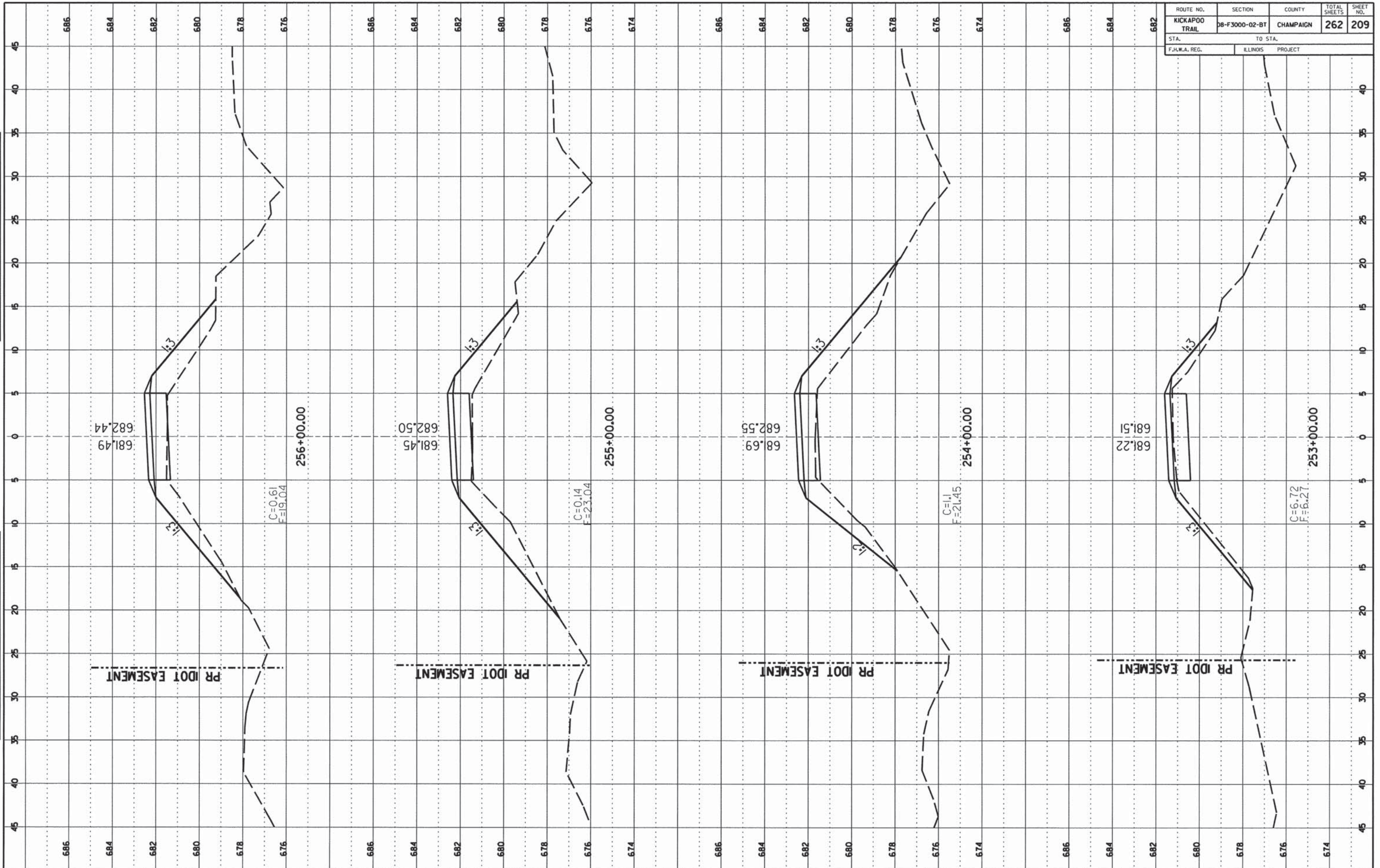

CCFPD KICKAPOO BIKE TRAIL CHAMPAIGN COUNTY

SHEET 209 OF 262 SHEETS 13-620A

CONTRACT NO. 91520

ROUTE NO.	SECTION	COUNTY	TOTAL SHEETS	SHEET NO.
KICKAPOO TRAIL	DB-F3000-02-BT	CHAMPAIGN	262	210
STA.		TO STA.		
F.H.W.A. REG.		ILLINOIS PROJECT		

FINAL SURVEY  
 NO. \_\_\_\_\_  
 DATE \_\_\_\_\_

ORIGINAL SURVEY  
 NO. \_\_\_\_\_  
 DATE \_\_\_\_\_

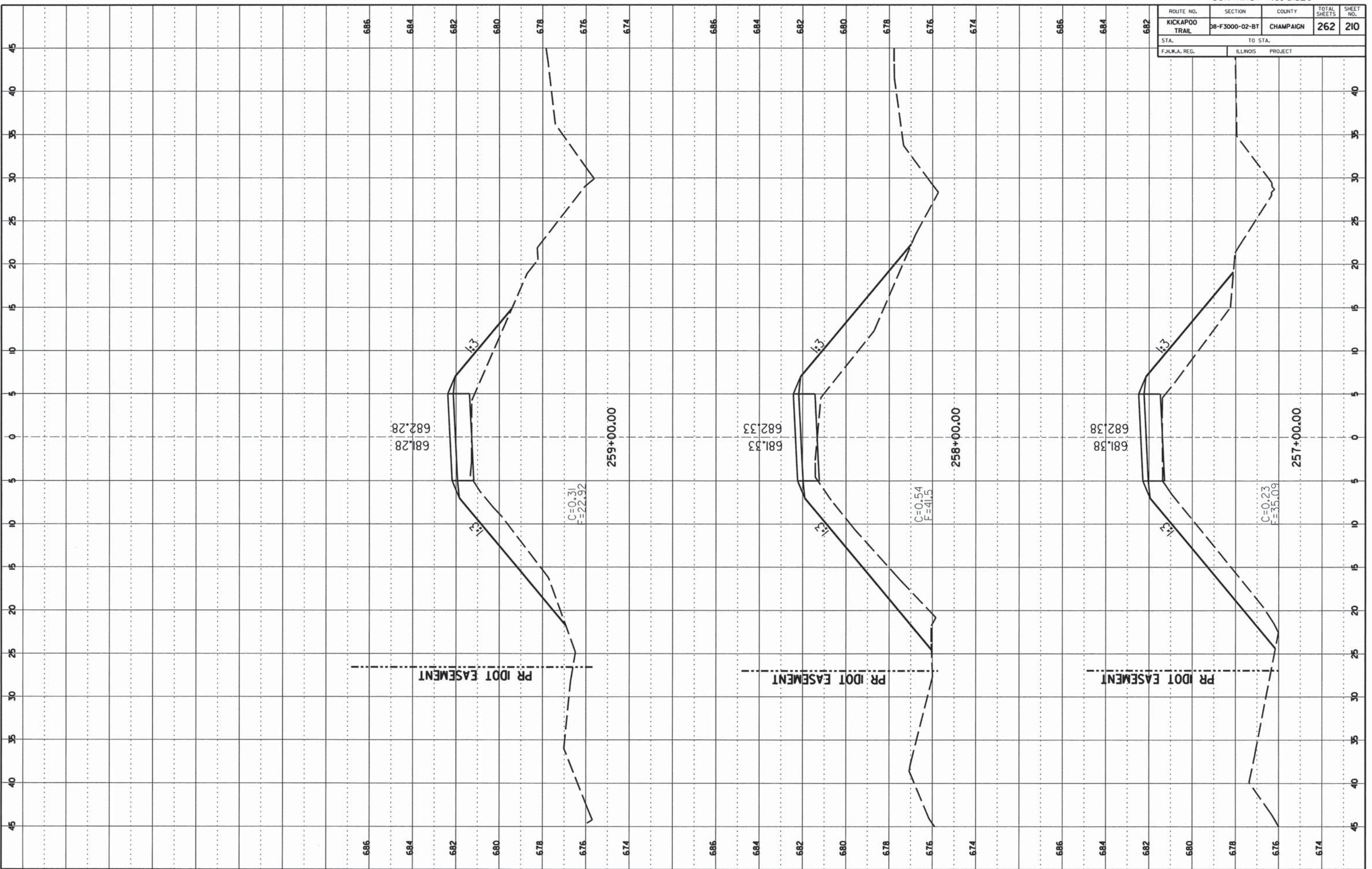

CCFPD KICKAPOO BIKE TRAIL

CHAMPAIGN COUNTY

SHEET 210 OF 262 SHEETS 13-620A

CONTRACT NO. 91520

ROUTE NO.	SECTION	COUNTY	TOTAL SHEETS	SHEET NO.
KICKAPOO TRAIL	D8-F3000-02-BT	CHAMPAIGN	262	211
STA.		TO STA.		
F.H.W.A. REG.		ILLINOIS PROJECT		

FINAL SURVEY	
SURVEYED	DATE
PLOTTED	
CHECKED	
APPROVED	
NO.	

ORIGINAL SURVEY	
SURVEYED	DATE
PLOTTED	
CHECKED	
APPROVED	
NO.	

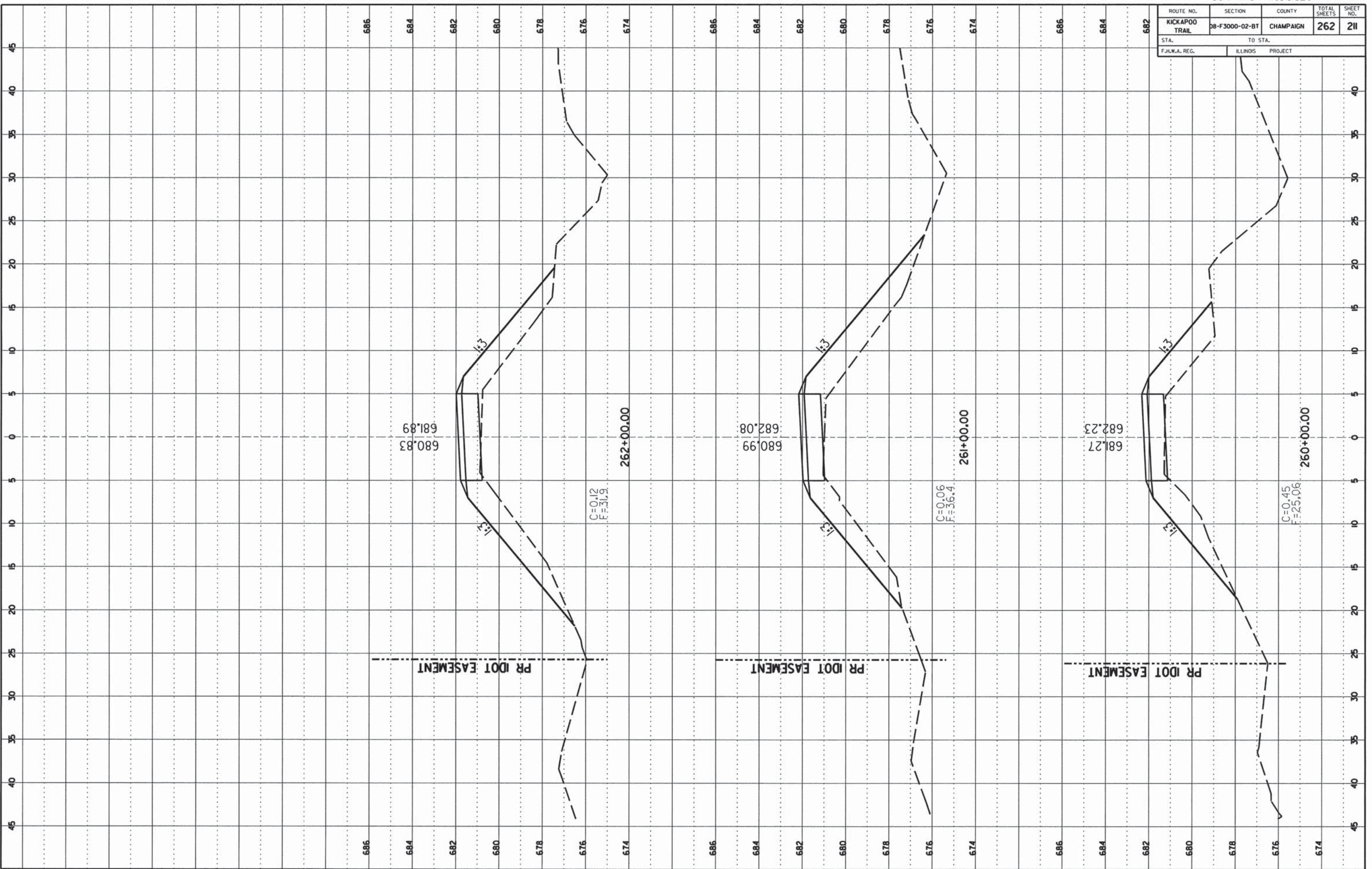

CONTRACT NO. 91520

ROUTE NO.	SECTION	COUNTY	TOTAL SHEETS	SHEET NO.
KICKAPOO TRAIL	08-F3000-02-BT	CHAMPAIGN	262	212
STA. TO STA.		ILLINOIS PROJECT		
F.H.W.A. REG.				

NO.	DATE	BY	DATE

NO.	DATE	BY	DATE

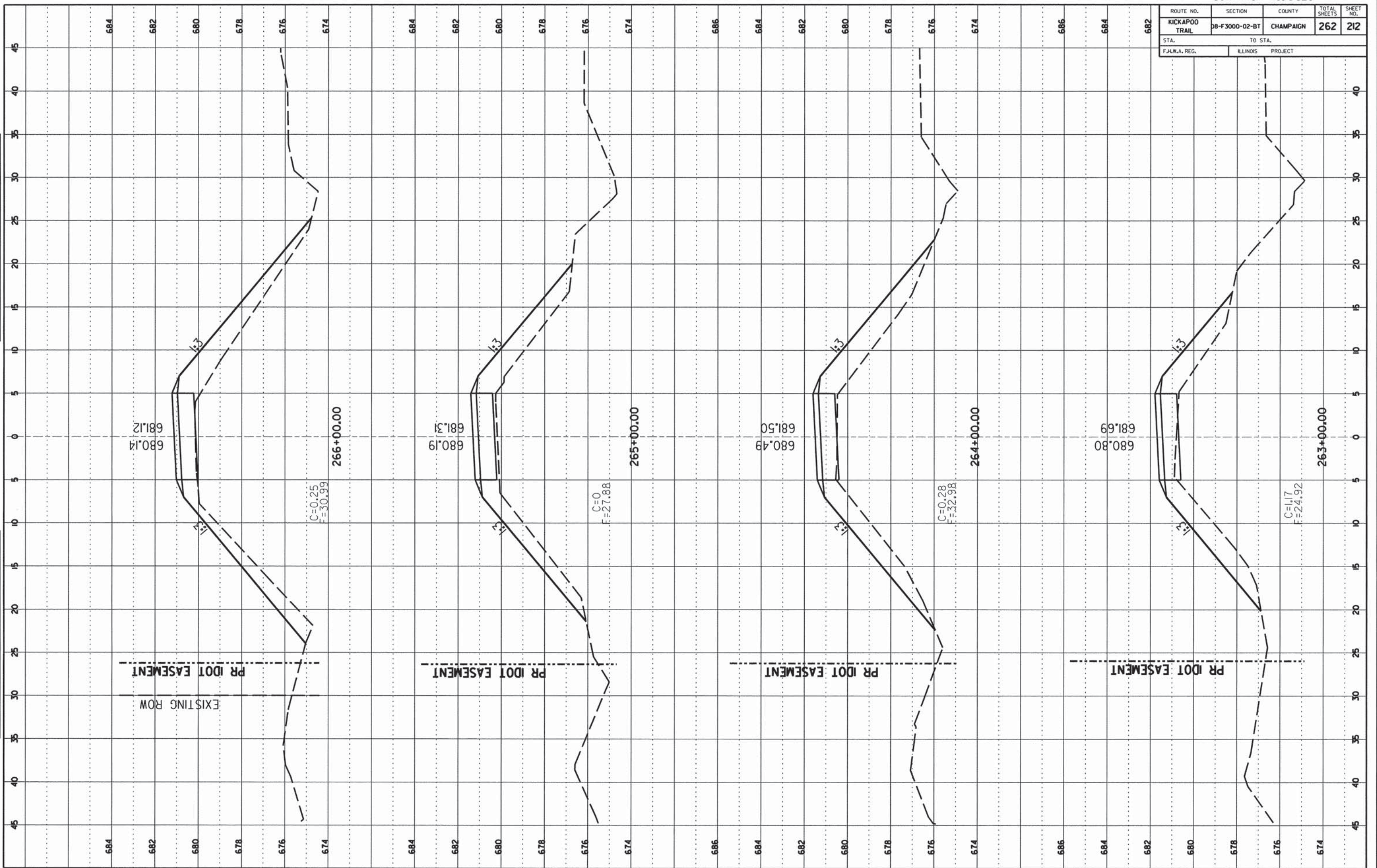

CCFPD KICKAPOO BIKE TRAIL CHAMPAIGN COUNTY

SHEET 212 OF 262 SHEETS I3-620A

CONTRACT NO. 91520

ROUTE NO.	SECTION	COUNTY	TOTAL SHEETS	SHEET NO.
KICKAPOO TRAIL	08-F3000-02-BT	CHAMPAIGN	262	213
STA.	TO STA.			
F.H.W.A. REG.	ILLINOIS	PROJECT		

FINAL SURVEY	SURVEYED	DATE
NOTE BOOK NO.	PLATINUM	
	AREA	
	NO.	

ORIGINAL SURVEY	SURVEYED	DATE
NOTE BOOK NO.	PLATINUM	
	AREA	
	NO.	

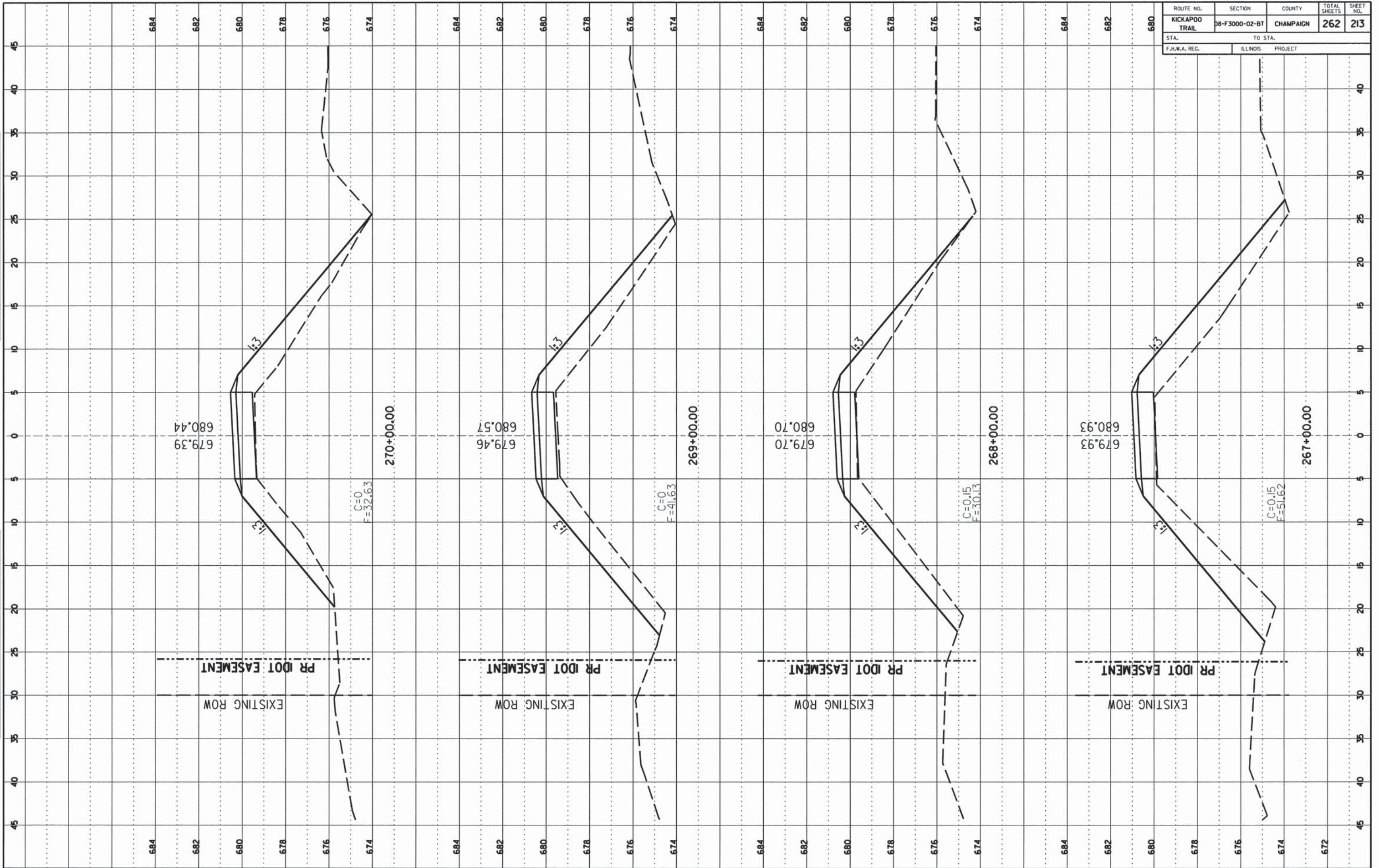

CCFPD KICKAPOO BIKE TRAIL CHAMPAIGN COUNTY

SHEET 213 OF 262 SHEETS 13-620A



CONTRACT NO. 91520

ROUTE NO.	SECTION	COUNTY	TOTAL SHEETS	SHEET NO.
KICKAPOO TRAIL	08-F3000-02-BT	CHAMPAIGN	262	214
STA.	TO STA.			
F.H.W.A. REG.	ILLINOIS	PROJECT		

FINAL SURVEY

DATE	
BY	
PROJECT	
PLANNED	
NO. _____	
DATE	
BY	
PROJECT	
PLANNED	
NO. _____	

ORIGINAL SURVEY

DATE	
BY	
PROJECT	
PLANNED	
NO. _____	
DATE	
BY	
PROJECT	
PLANNED	
NO. _____	

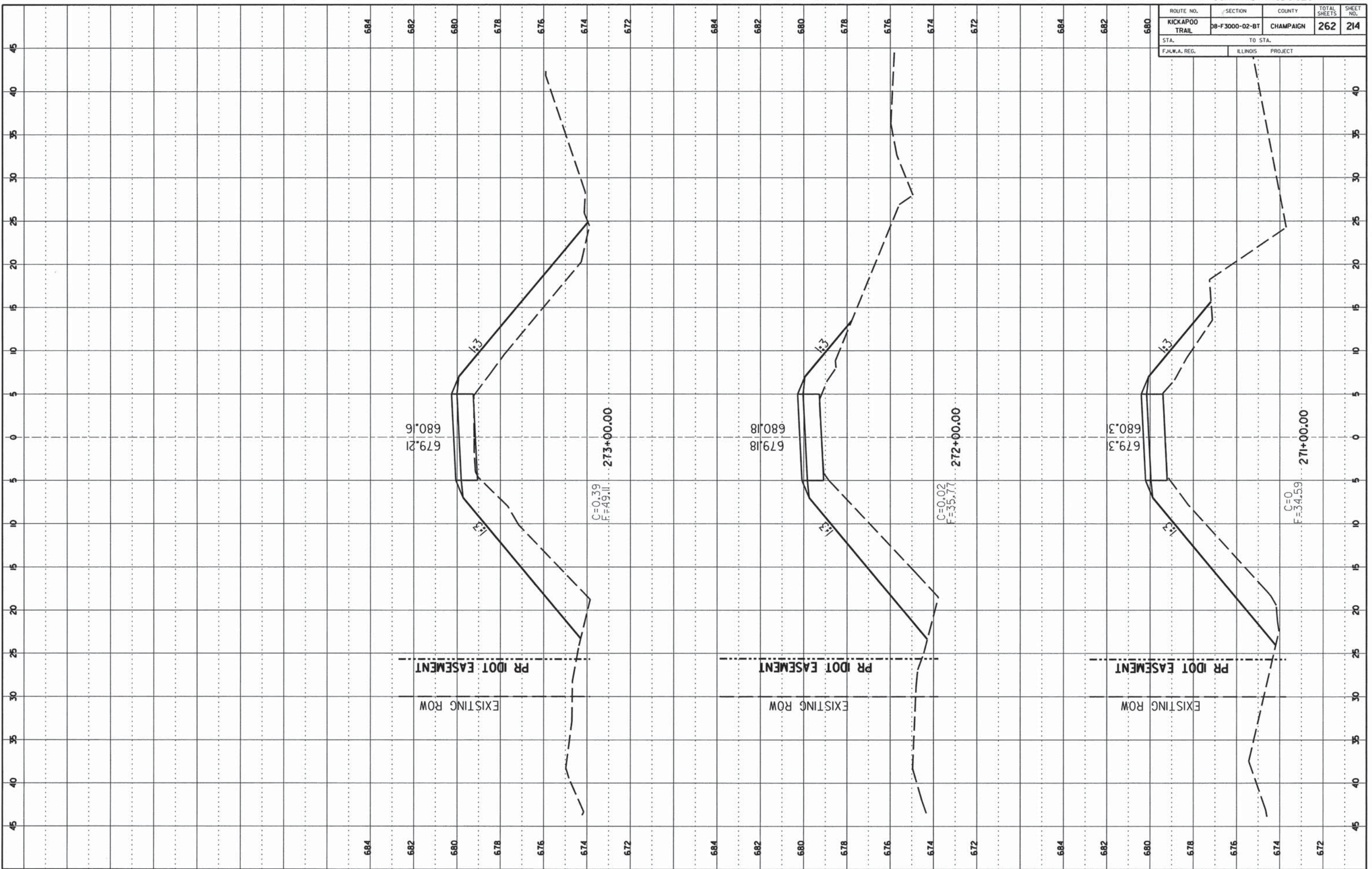

680.6  
679.21

C=0.39  
F=49.11  
273+00.00

680.18  
679.18

C=0.02  
F=35.77  
272+00.00

680.3  
679.3

C=0  
F=34.59  
271+00.00

EXISTING ROW  
PR IDOT EASEMENT

EXISTING ROW  
PR IDOT EASEMENT

EXISTING ROW  
PR IDOT EASEMENT

CONTRACT NO. 91520

ROUTE NO.	SECTION	COUNTY	TOTAL SHEETS	SHEET NO.
KICKAPOO TRAIL	D8-F3000-02-BT	CHAMPAIGN	262	215
STA.		TO STA.		
F.H.W.A. REG.		ILLINOIS PROJECT		

FINAL SURVEY

NO.	DATE

ORIGINAL SURVEY

NO.	DATE

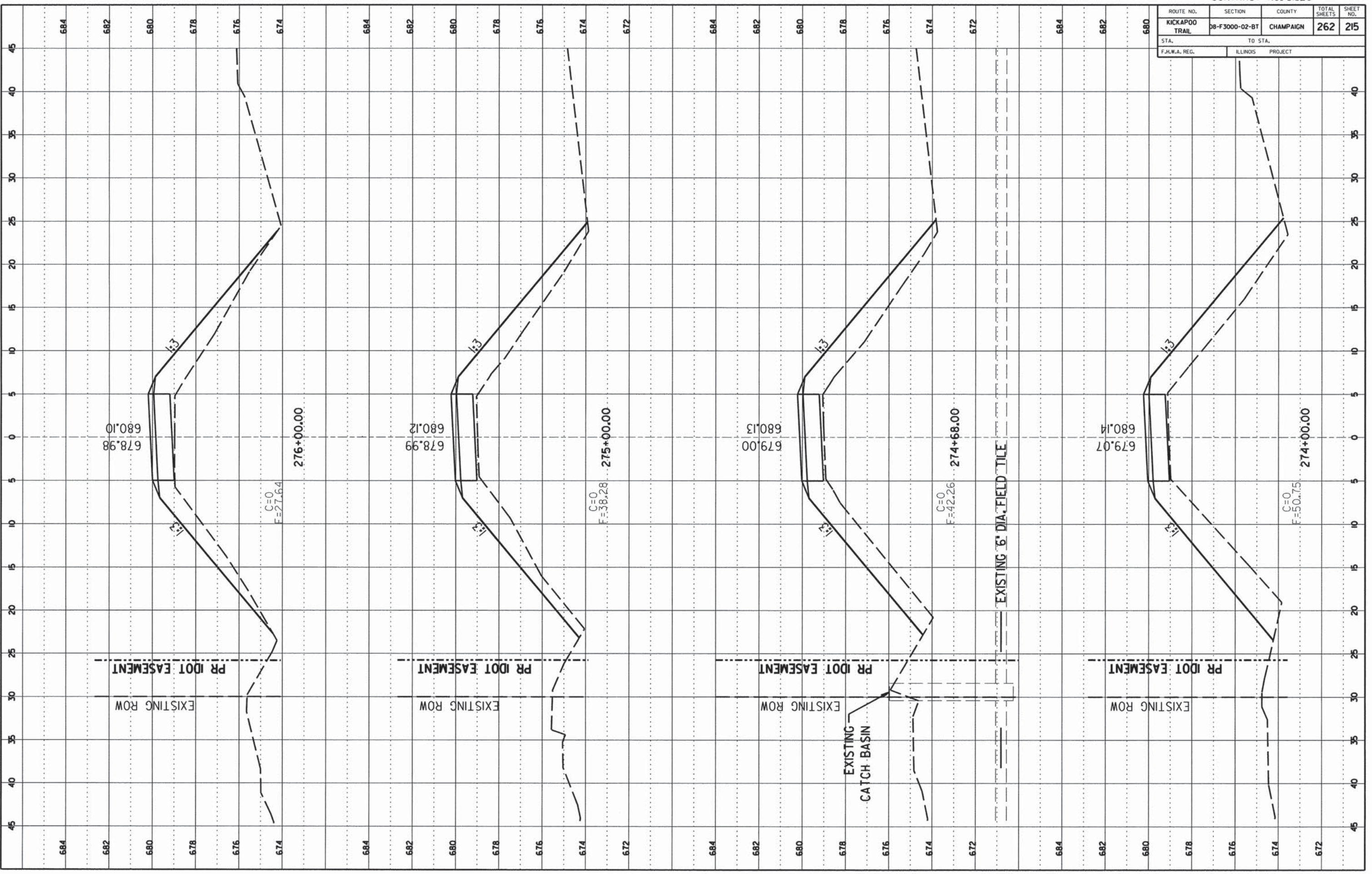

CONTRACT NO. 91520

ROUTE NO.	SECTION	COUNTY	TOTAL SHEETS	SHEET NO.
KICKAPOO TRAIL	08-F3000-02-BT	CHAMPAIGN	262	216
STA. TO STA.		F.H.W.A. REG. ILLINOIS PROJECT		

NO.	DATE	BY	REVISION

NO.	DATE	BY	REVISION

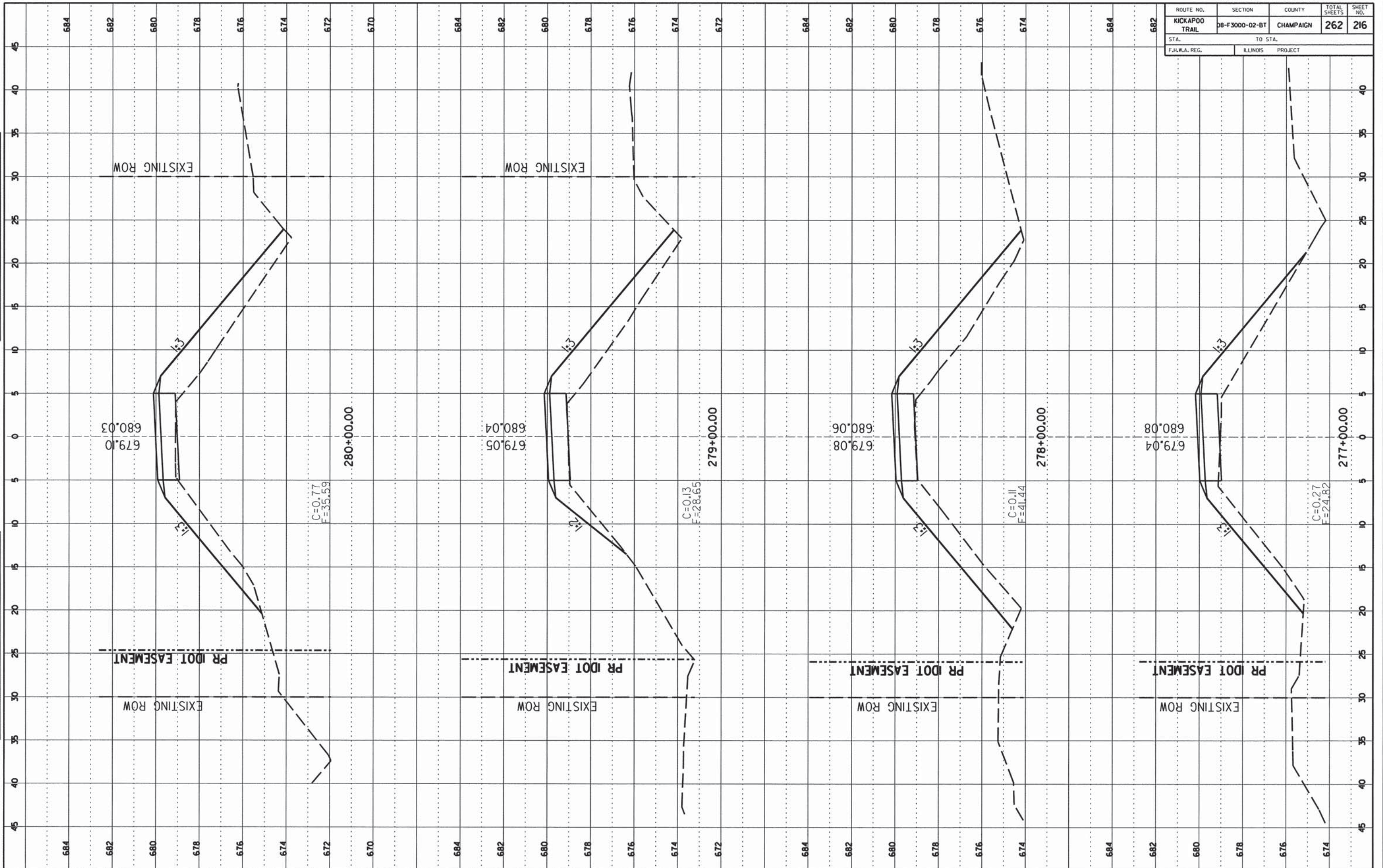

CONTRACT NO. 91520

ROUTE NO.	SECTION	COUNTY	TOTAL SHEETS	SHEET NO.
KICKAPOO TRAIL	08-F3000-02-BT	CHAMPAIGN	262	217
STA. _____		TO STA. _____		
F.H.W.A. REG. _____		ILLINOIS PROJECT _____		

DATE	BY

FINAL SURVEY  
 REVISIONS:  
 NO. \_\_\_\_\_ DATE \_\_\_\_\_ BY \_\_\_\_\_  
 NOTE BOOK NO. \_\_\_\_\_  
 JANS 2016

DATE	BY

ORIGINAL SURVEY  
 REVISIONS:  
 NO. \_\_\_\_\_ DATE \_\_\_\_\_ BY \_\_\_\_\_  
 NOTE BOOK NO. \_\_\_\_\_  
 JANS 2016

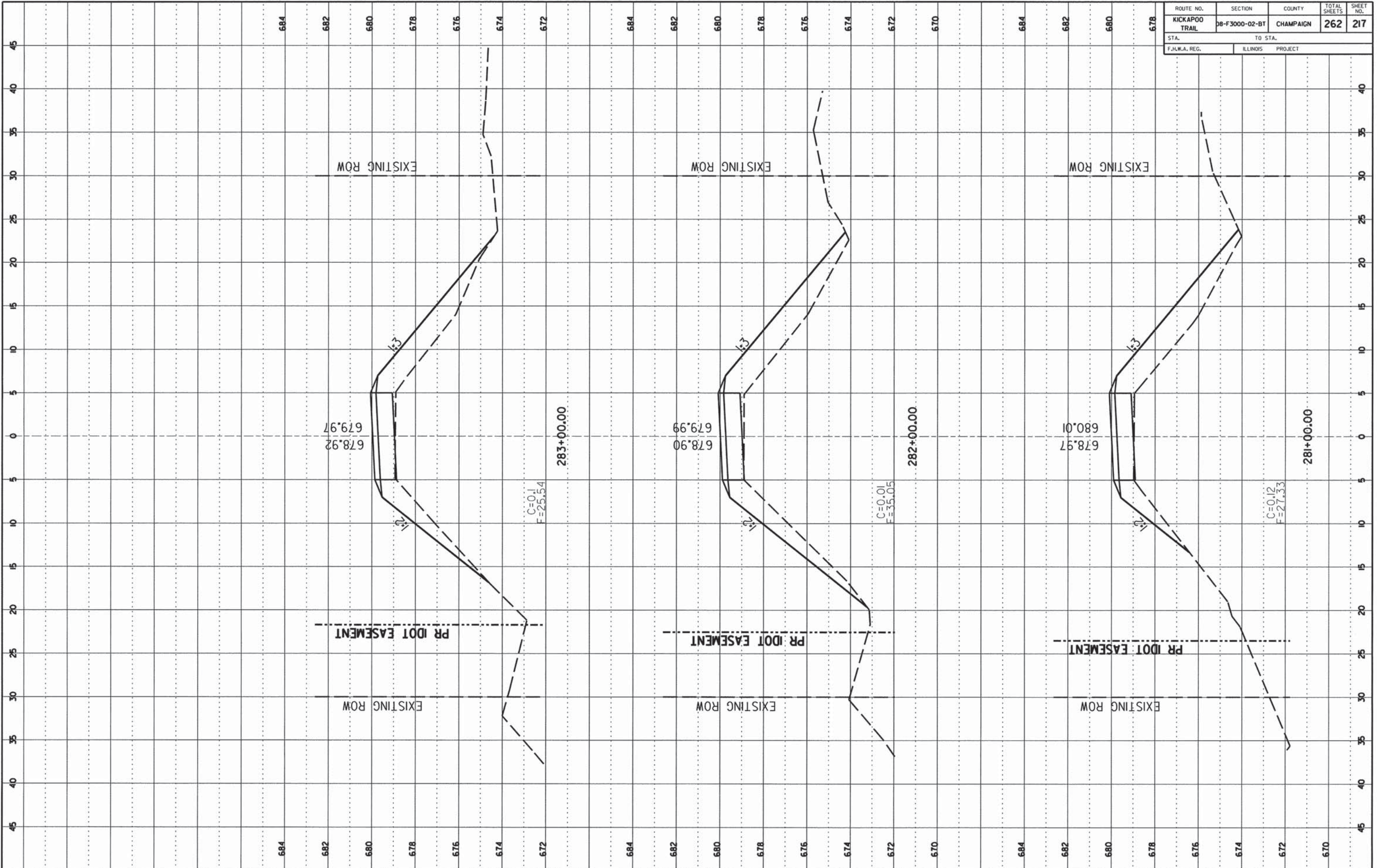

CCFPD KICKAPOO BIKE TRAIL

CHAMPAIGN COUNTY

SHEET 217 OF 262 SHEETS 13-620A

CONTRACT NO. 91520

ROUTE NO.	SECTION	COUNTY	TOTAL SHEETS	SHEET NO.
KICKAPOO TRAIL	D8-F3000-02-BT	CHAMPAIGN	262	218
STA.		TO STA.		
F.I.L.W.A. REG.		ILLINOIS PROJECT		

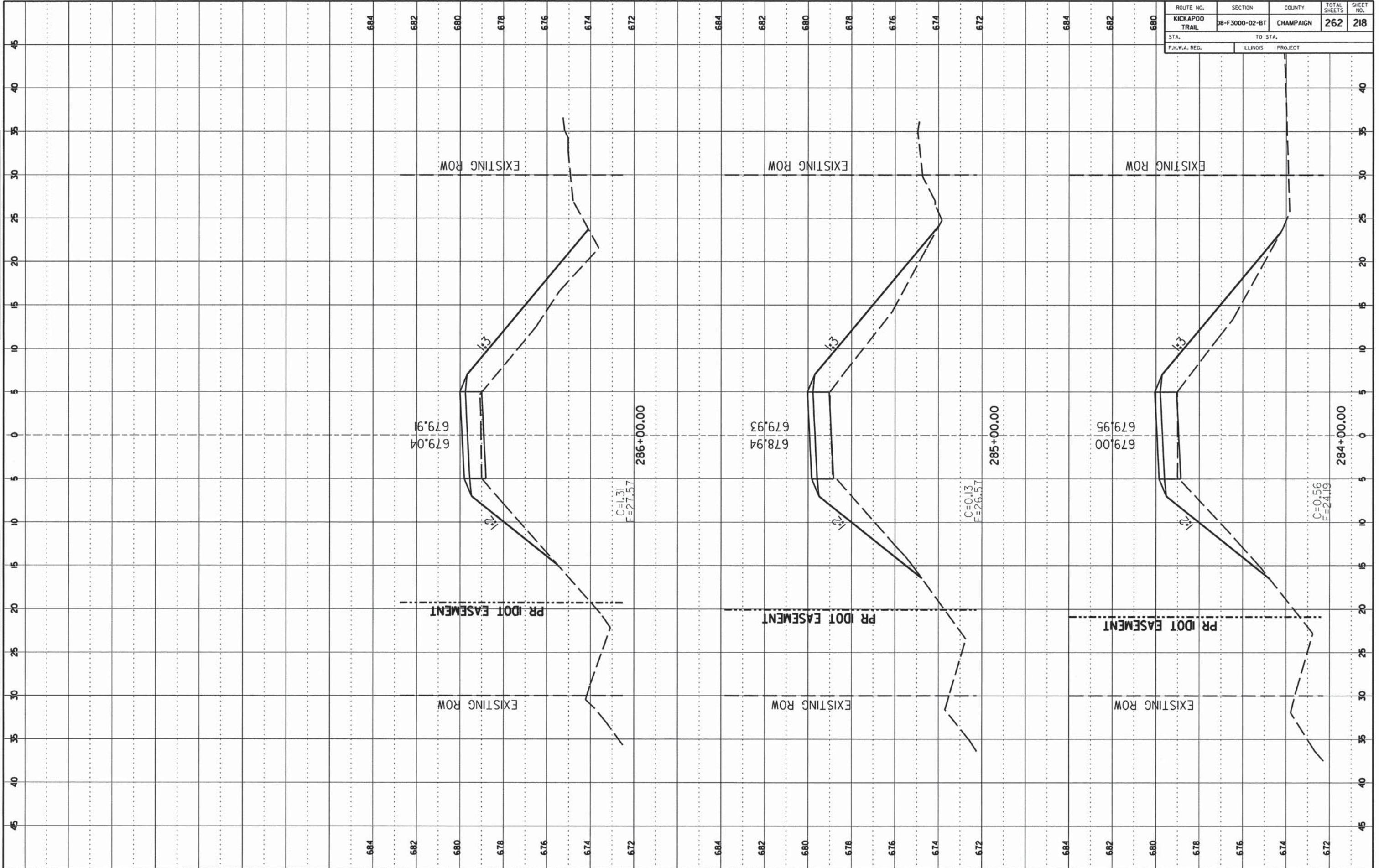

FINAL SURVEY

DATE: \_\_\_\_\_

BY: \_\_\_\_\_

NO. \_\_\_\_\_

AREAS CHECKED: \_\_\_\_\_

ORIGINAL SURVEY

DATE: \_\_\_\_\_

BY: \_\_\_\_\_

NO. \_\_\_\_\_

AREAS CHECKED: \_\_\_\_\_

CONTRACT NO. 91520

ROUTE NO.	SECTION	COUNTY	TOTAL SHEETS	SHEET NO.
KICKAPOO TRAIL	08-F3000-02-BT	CHAMPAIGN	262	219
STA.	TO STA.			
F.H.W.A. REG.	ILLINOIS	PROJECT		

FINAL SURVEY  
 SUPERVISOR: \_\_\_\_\_  
 DRAWN BY: \_\_\_\_\_  
 CHECKED BY: \_\_\_\_\_  
 DATE: \_\_\_\_\_

ORIGINAL SURVEY  
 SUPERVISOR: \_\_\_\_\_  
 DRAWN BY: \_\_\_\_\_  
 CHECKED BY: \_\_\_\_\_  
 DATE: \_\_\_\_\_

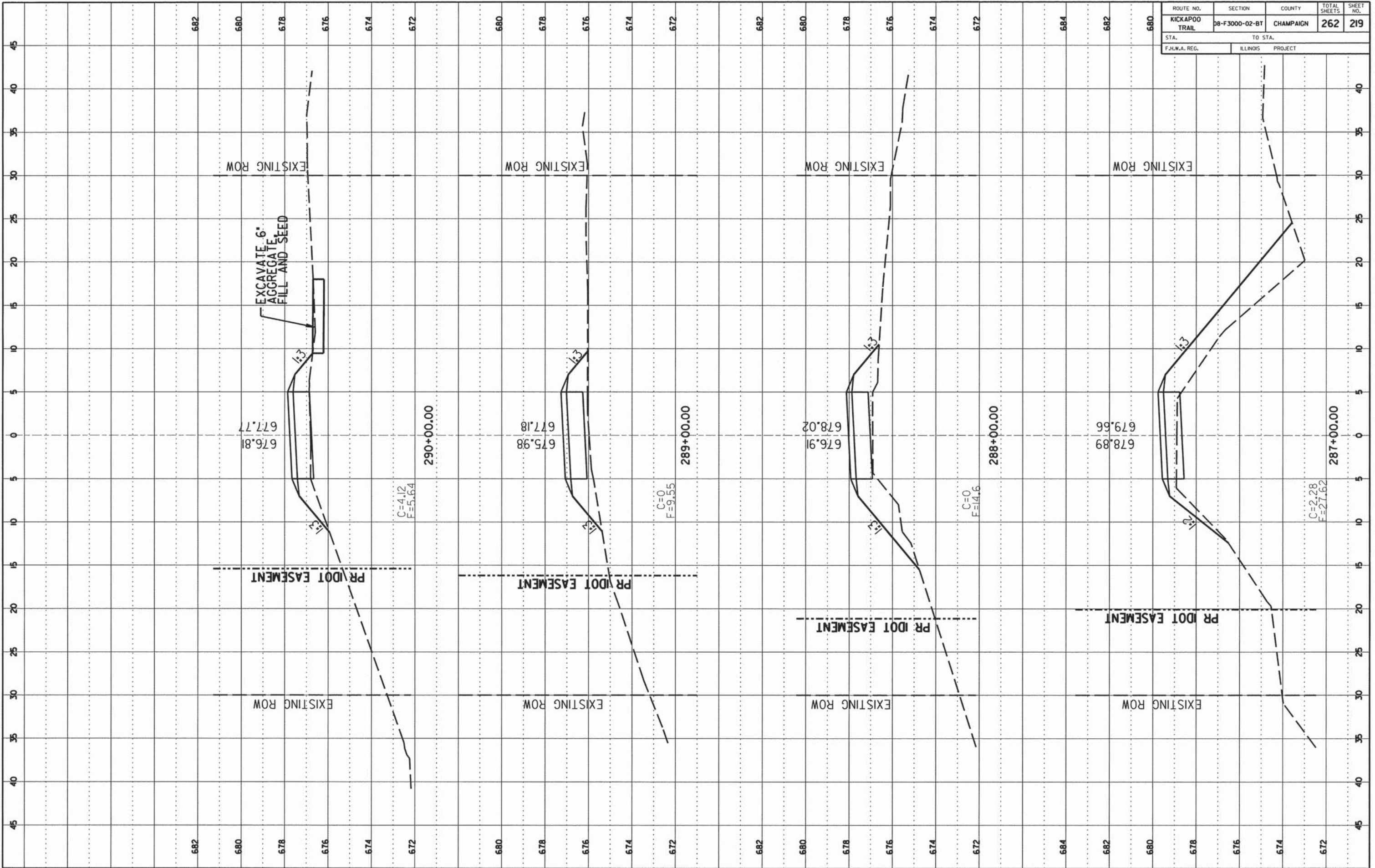

CONTRACT NO. 91520

ROUTE NO.	SECTION	COUNTY	TOTAL SHEETS	SHEET NO.
KICKAPOO TRAIL	DB-F3000-02-BT	CHAMPAIGN	262	220
STA. TO STA.		ILLINOIS PROJECT		
F.H.W.A. REG.				

FINAL SURVEY

DATE	
BY	
PROJECT	
PLATTED	
MARKED	
NOTE BOOK NO.	
AREA SECTED	

ORIGINAL SURVEY

DATE	
BY	
PROJECT	
PLATTED	
MARKED	
NOTE BOOK NO.	
AREA SECTED	

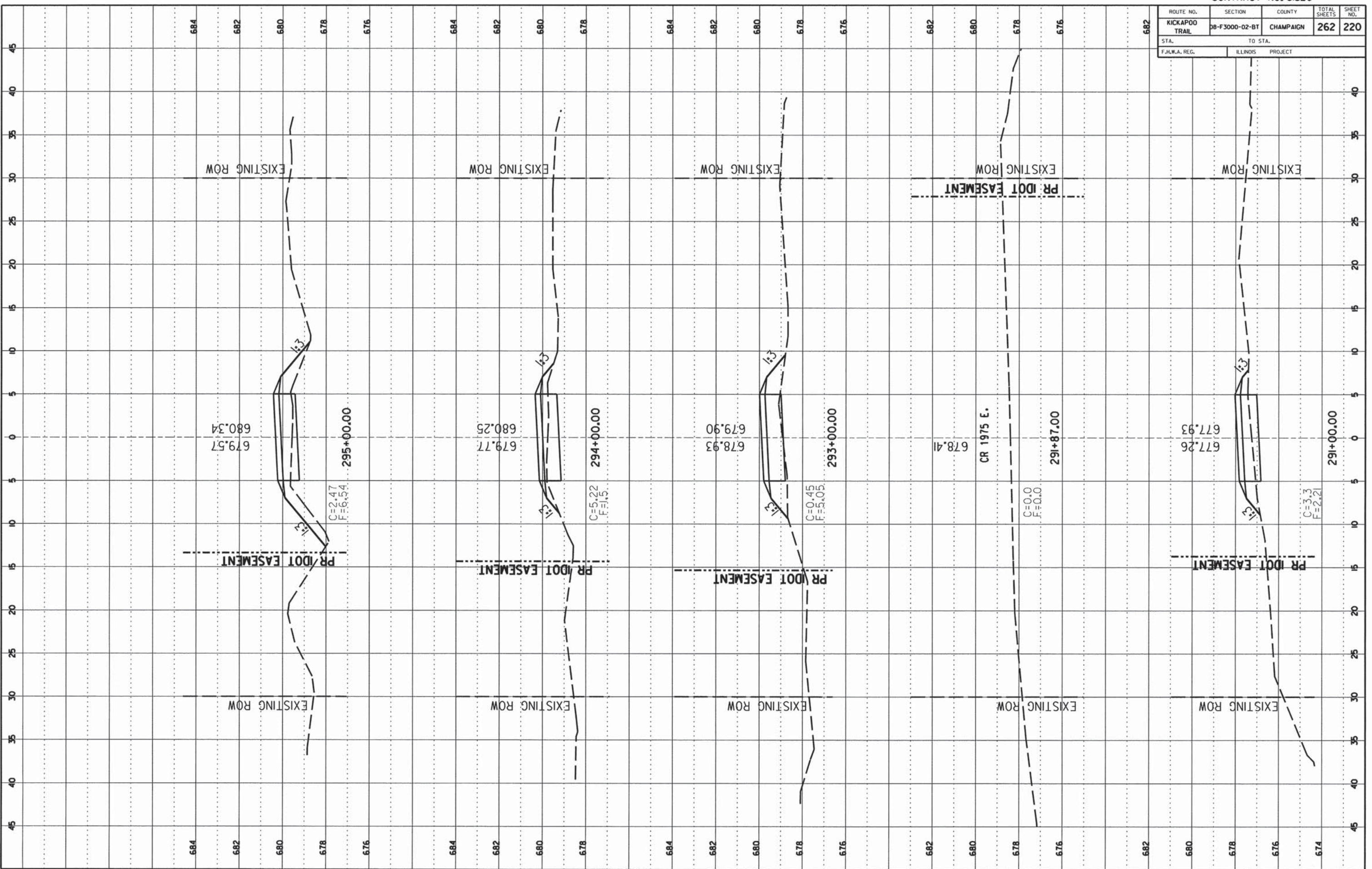

CONTRACT NO. 91520

ROUTE NO.	SECTION	COUNTY	TOTAL SHEETS	SHEET NO.
KICKAPOO TRAIL	DB-F3000-02-BT	CHAMPAIGN	262	221
STA.	TO STA.			
F.H.W.A. REG.	ILLINOIS	PROJECT		

FINAL SURVEY  
 NO. \_\_\_\_\_  
 DATE \_\_\_\_\_

ORIGINAL SURVEY  
 NO. \_\_\_\_\_  
 DATE \_\_\_\_\_

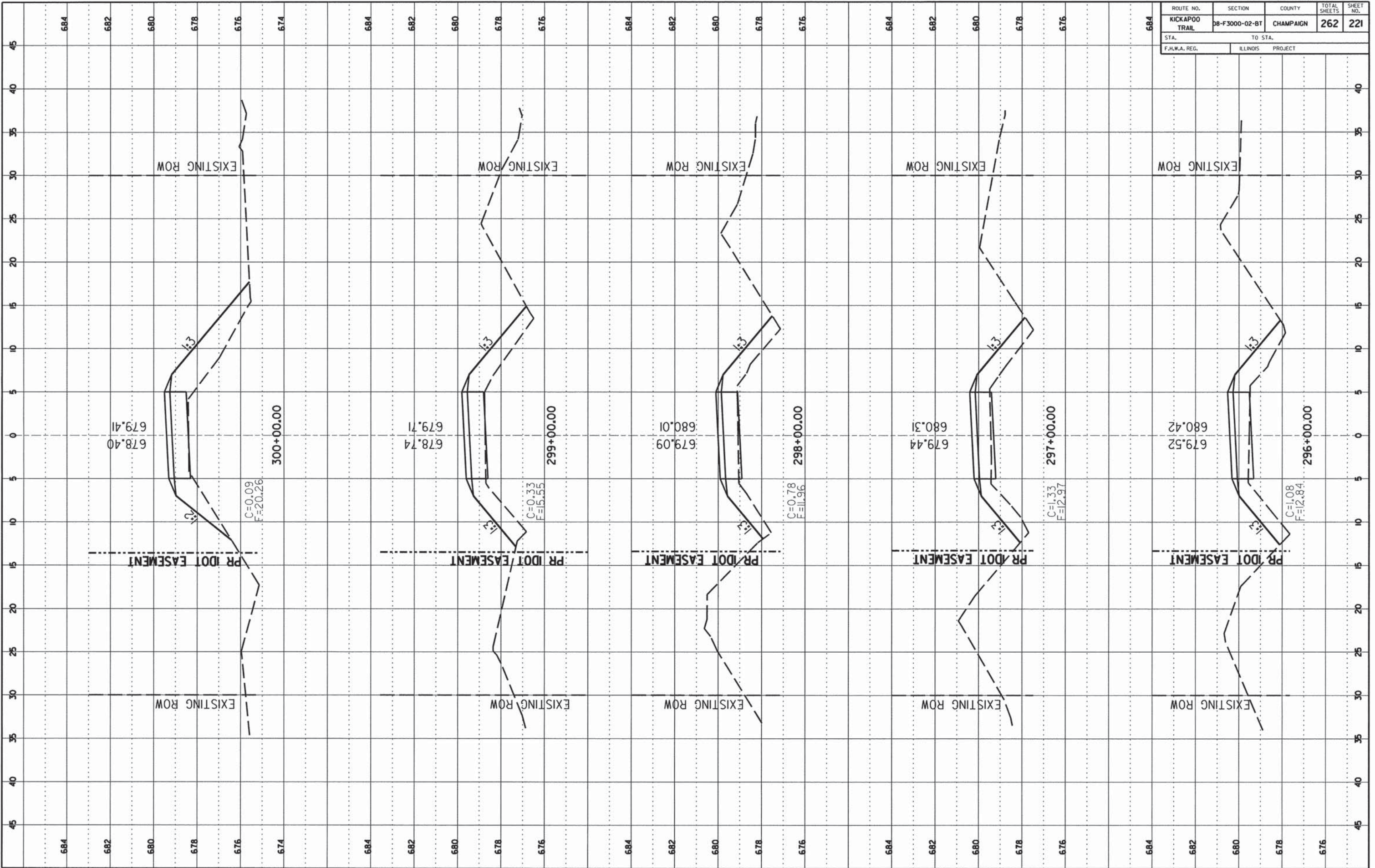



CONTRACT NO. 91520

ROUTE NO.	SECTION	COUNTY	TOTAL SHEETS	SHEET NO.
KICKAPOO TRAIL	DB-F3000-02-BT	CHAMPAIGN	262	222
STA.	TO STA.			
F.H.W.A. REG.	ILLINOIS PROJECT			

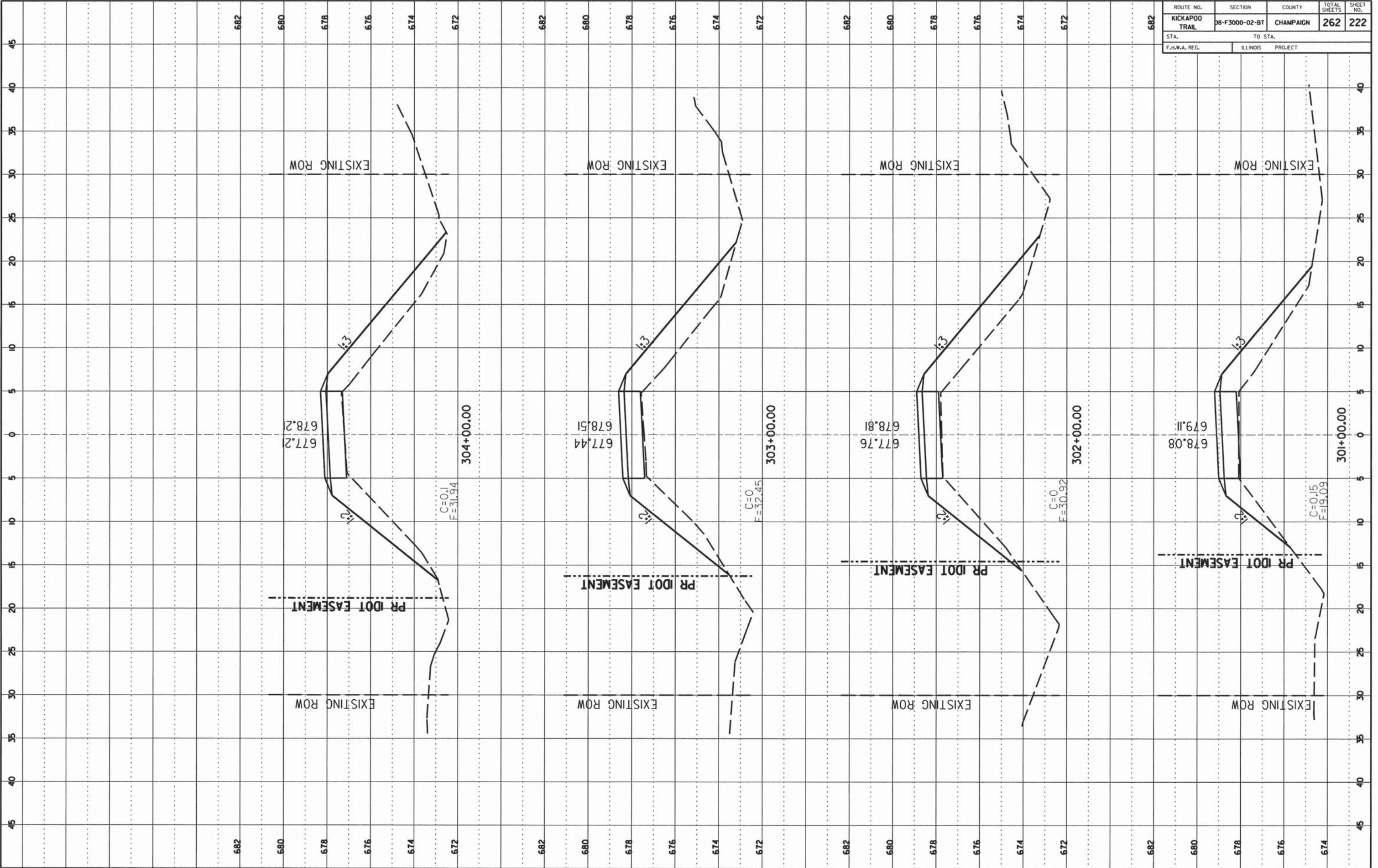

FINAL SURVEY

DATE	
BY	
PROJECT	
NOTE BOOK NO.	
DATE RECEIVED	

ORIGINAL SURVEY

DATE	
BY	
PROJECT	
NOTE BOOK NO.	
DATE RECEIVED	

CONTRACT NO. 91520

ROUTE NO.	SECTION	COUNTY	TOTAL SHEETS	SHEET NO.
KICKAPOO TRAIL	08-F3000-02-BT	CHAMPAIGN	262	223
STA.	TO STA.			
F.H.W.A. REG.	ILLINOIS PROJECT			

FINAL SURVEY  
 NO. \_\_\_\_\_ DATE \_\_\_\_\_  
 BY \_\_\_\_\_  
 CHECKED \_\_\_\_\_  
 SUPERVISOR \_\_\_\_\_  
 PLANNING \_\_\_\_\_  
 DESIGN \_\_\_\_\_  
 CONSTRUCTION \_\_\_\_\_

ORIGINAL SURVEY  
 NO. \_\_\_\_\_ DATE \_\_\_\_\_  
 BY \_\_\_\_\_  
 CHECKED \_\_\_\_\_  
 SUPERVISOR \_\_\_\_\_  
 PLANNING \_\_\_\_\_  
 DESIGN \_\_\_\_\_  
 CONSTRUCTION \_\_\_\_\_

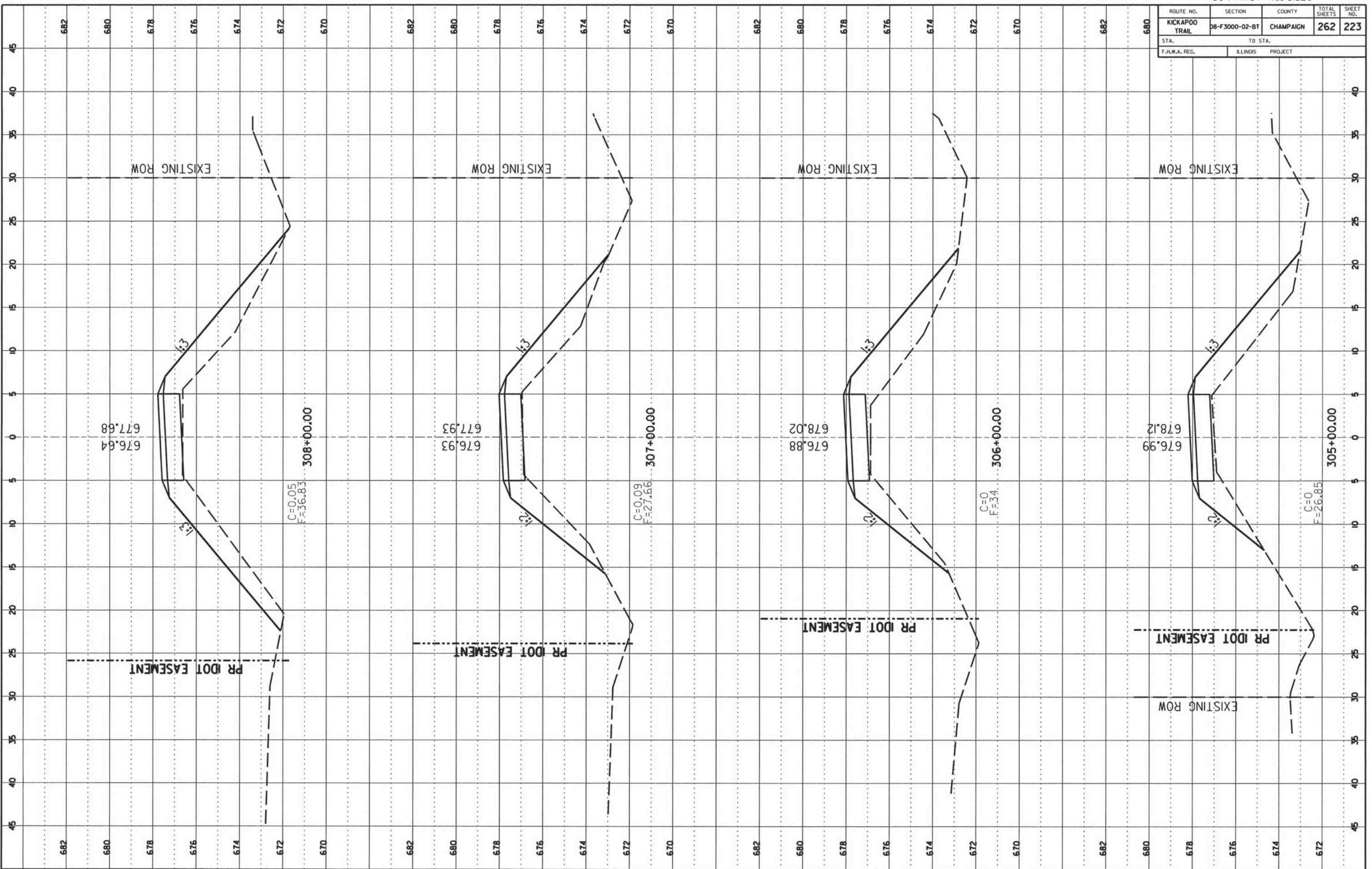

CCFPD KICKAPOO BIKE TRAIL CHAMPAIGN COUNTY

CONTRACT NO. 91520

ROUTE NO.	SECTION	COUNTY	TOTAL SHEETS	SHEET NO.
KICKAPOO TRAIL	08-F3000-02-BT	CHAMPAIGN	262	224
STA.		TO STA.		
F.H.W.A. REG.		ILLINOIS PROJECT		

DATE	BY

FINAL SURVEY  
 NOTE BOOK NO. \_\_\_\_\_  
 AREA CHECKED \_\_\_\_\_

DATE	BY

ORIGINAL SURVEY  
 NOTE BOOK NO. \_\_\_\_\_  
 AREA CHECKED \_\_\_\_\_

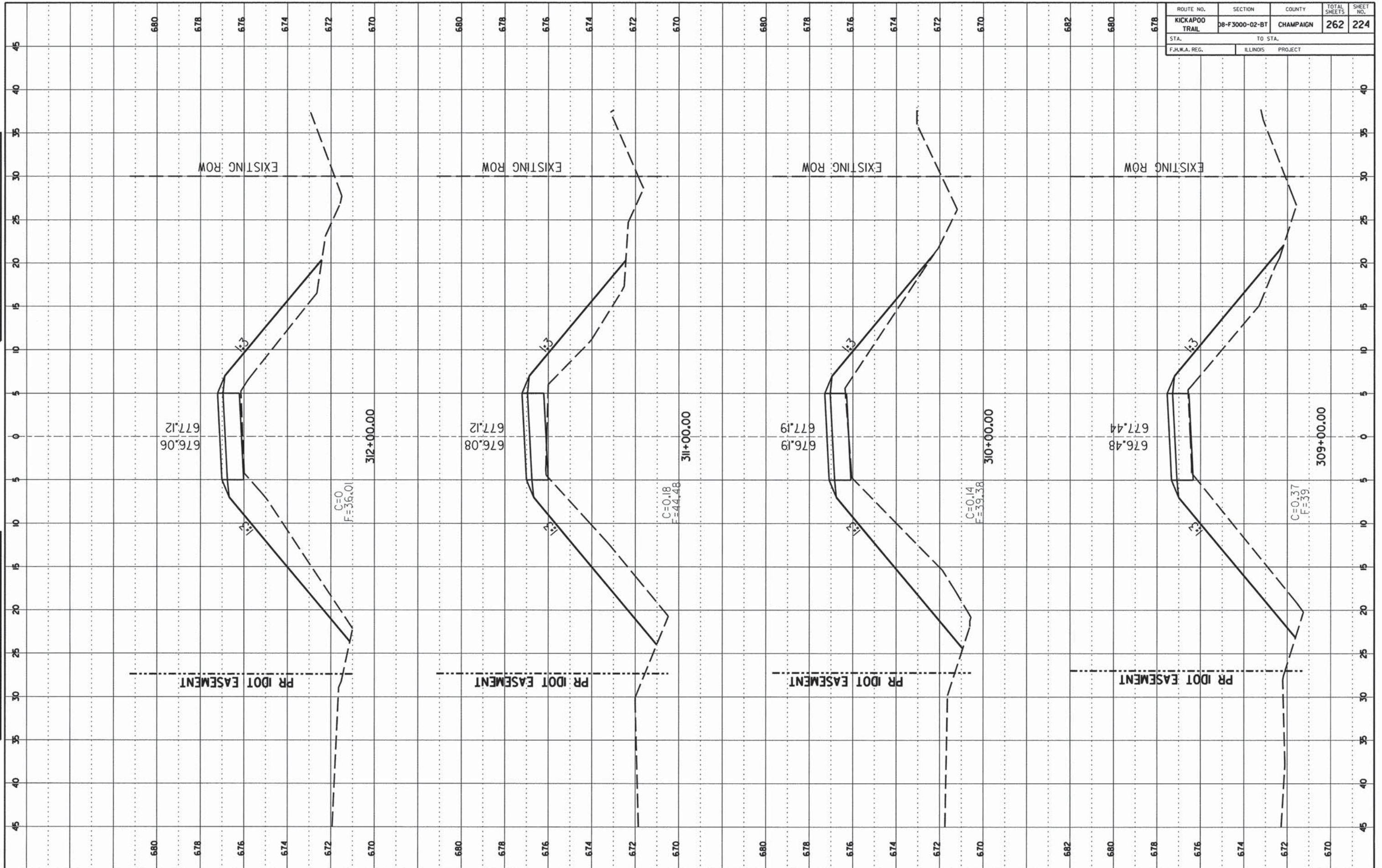

CONTRACT NO. 91520

ROUTE NO.	SECTION	COUNTY	TOTAL SHEETS	SHEET NO.
KICKAPOO TRAIL	DB-F3000-02-BT	CHAMPAIGN	262	225
STA.		TO STA.		
F.H.W.A. REG.		ILLINOIS PROJECT		

FINAL SURVEY

DATE: \_\_\_\_\_

BY: \_\_\_\_\_

NO. \_\_\_\_\_

AREA ORDER \_\_\_\_\_

ORIGINAL SURVEY

DATE: \_\_\_\_\_

BY: \_\_\_\_\_

NO. \_\_\_\_\_

AREA ORDER \_\_\_\_\_

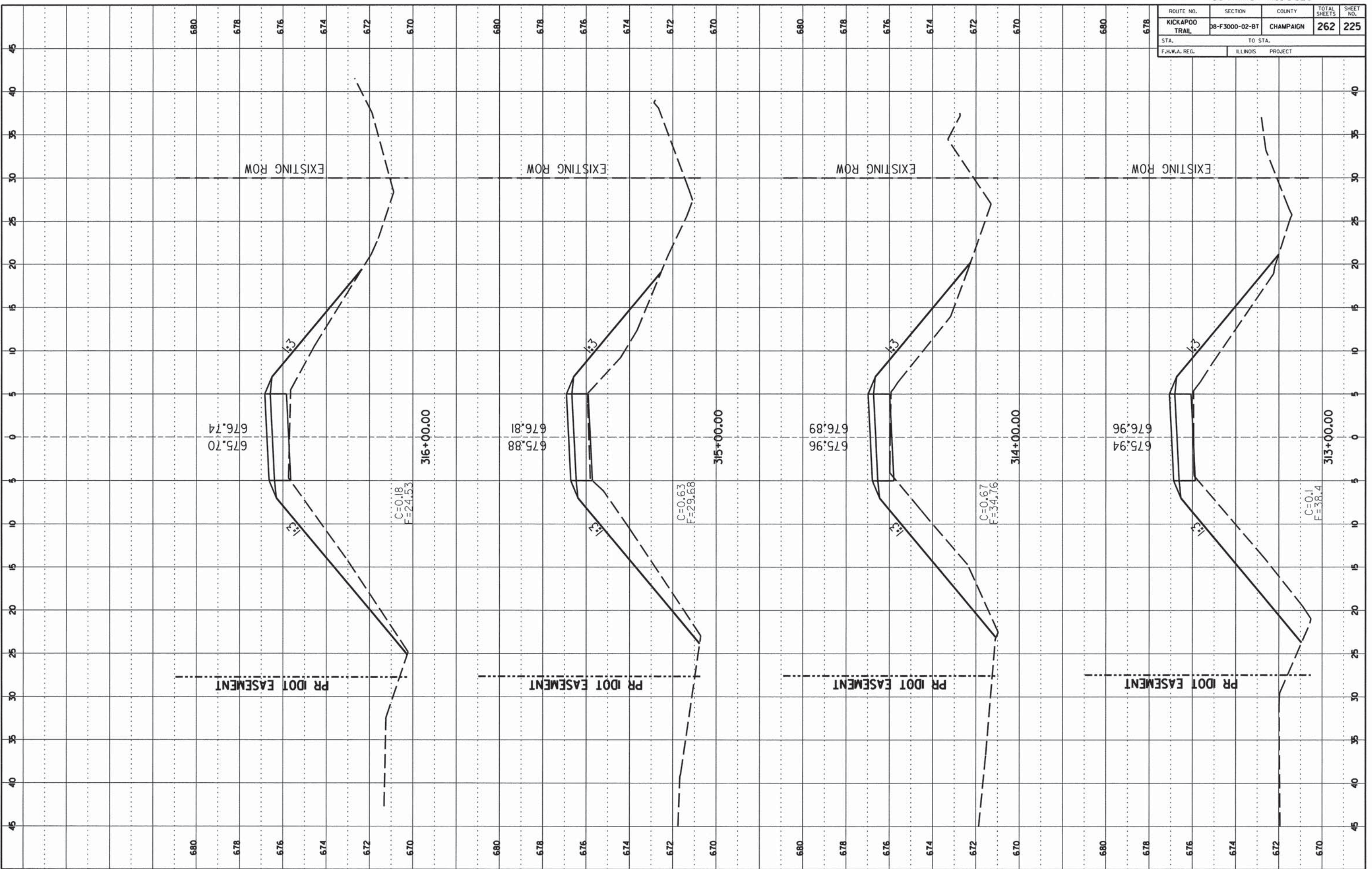

CCFPD KICKAPOO BIKE TRAIL CHAMPAIGN COUNTY

SHEET 225 OF 262 SHEETS 13-620A

CONTRACT NO. 91520

ROUTE NO.	SECTION	COUNTY	TOTAL SHEETS	SHEET NO.
KICKAPOO TRAIL	08-F3000-02-BT	CHAMPAIGN	262	226
STA. TO STA.		ILLINOIS PROJECT		
F.H.W.A. REG.				

FINAL SURVEY NOTE BOOK NO. BY DATE

ORIGINAL SURVEY NOTE BOOK NO. BY DATE

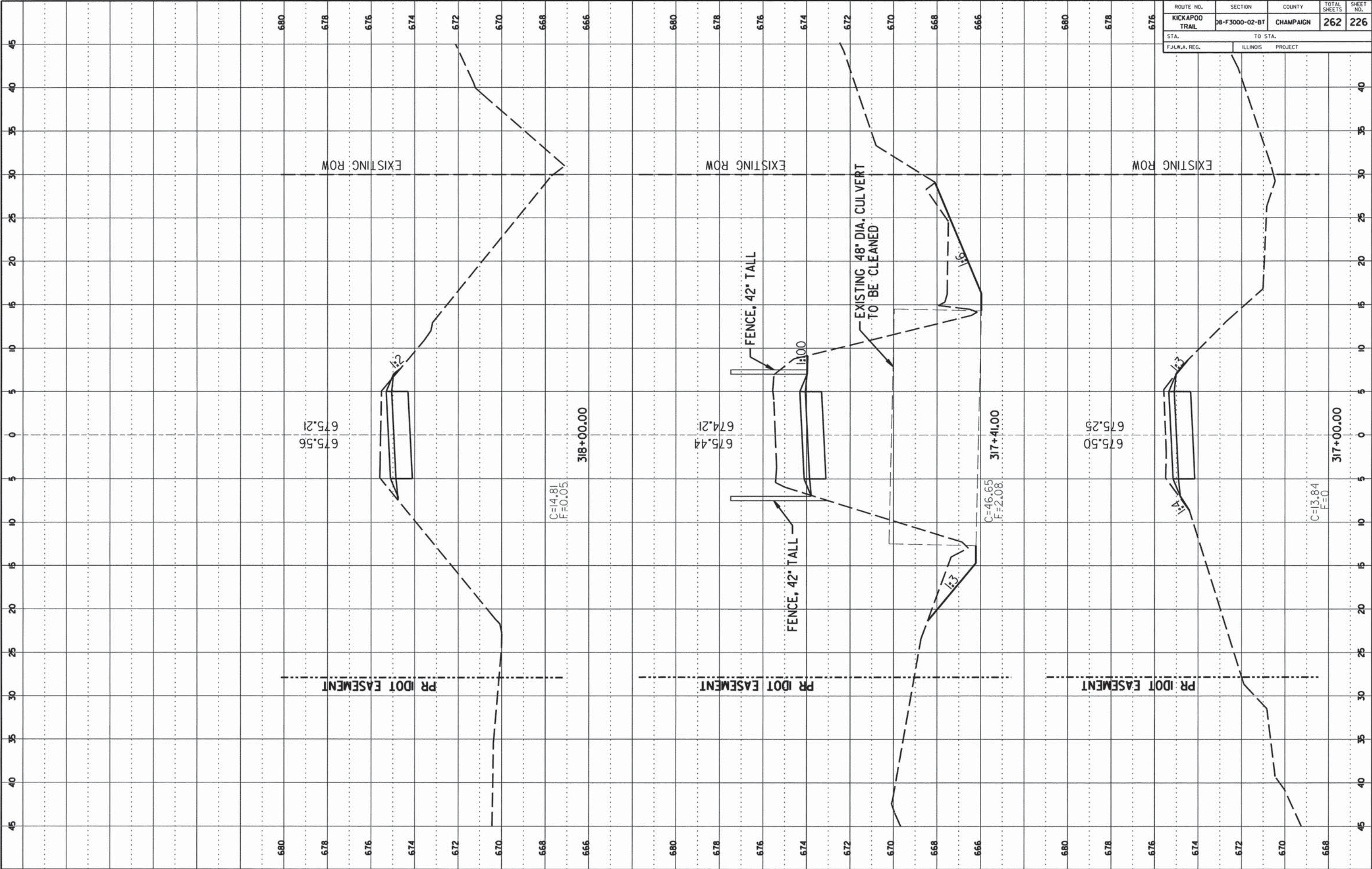

CONTRACT NO. 91520

ROUTE NO.	SECTION	COUNTY	TOTAL SHEETS	SHEET NO.
KICKAPOO TRAIL	D8-F3000-02-BT	CHAMPAIGN	262	227
STA. F.J.W.A. REG.		TO STA. ILLINOIS PROJECT		

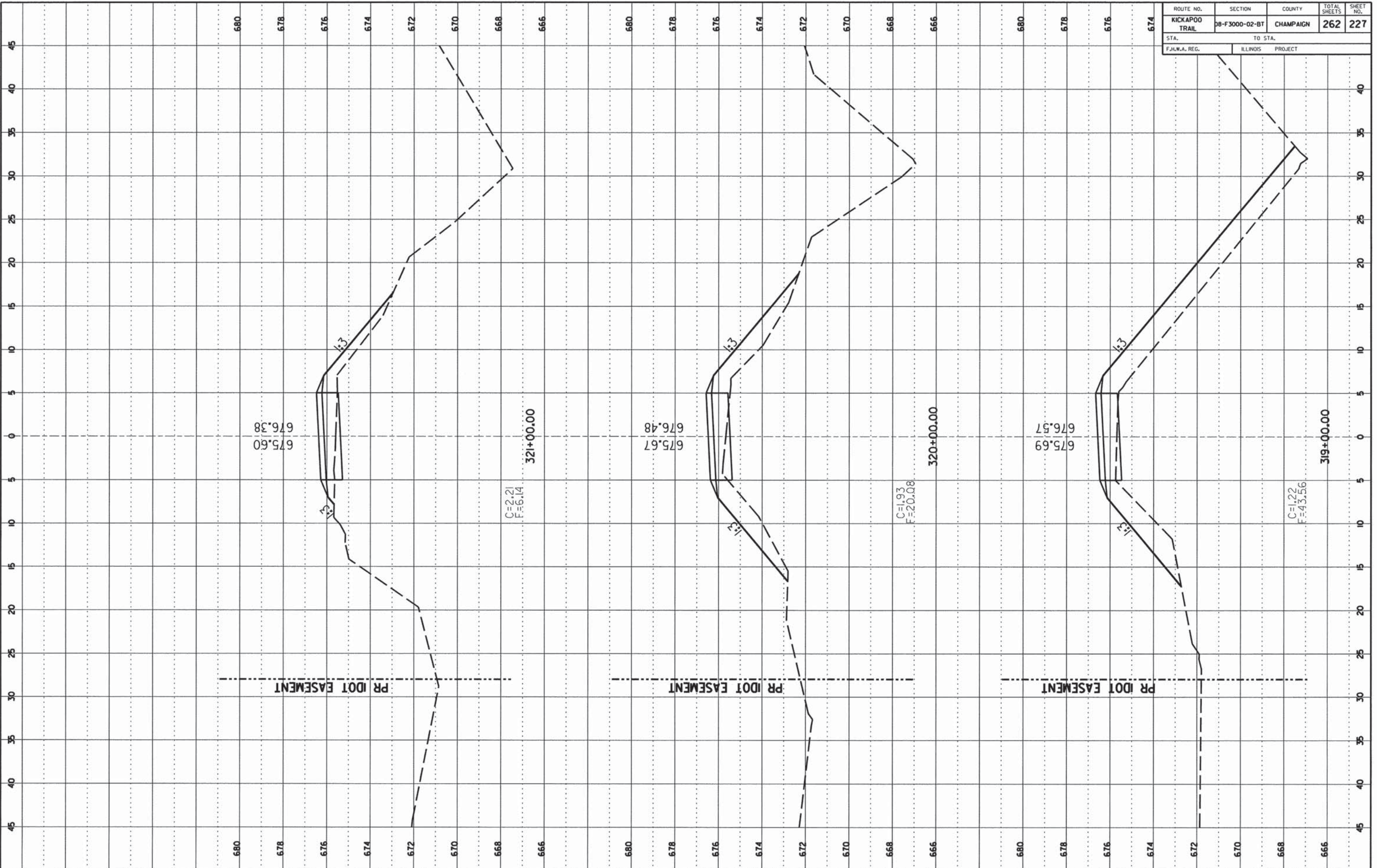

FINAL SURVEY  
 DATE: \_\_\_\_\_  
 BY: \_\_\_\_\_  
 CHECKED: \_\_\_\_\_  
 NO. \_\_\_\_\_

ORIGINAL SURVEY  
 DATE: \_\_\_\_\_  
 BY: \_\_\_\_\_  
 CHECKED: \_\_\_\_\_  
 NO. \_\_\_\_\_

CONTRACT NO. 91520

ROUTE NO.	SECTION	COUNTY	TOTAL SHEETS	SHEET NO.
KICKAPOO TRAIL	08-F3000-02-BT	CHAMPAIGN	262	228
STA.		TO STA.		
F.H.W.A. REG.		ILLINOIS PROJECT		

FINAL SURVEY  
 NO. \_\_\_\_\_  
 DATE \_\_\_\_\_

ORIGINAL SURVEY  
 NO. \_\_\_\_\_  
 DATE \_\_\_\_\_

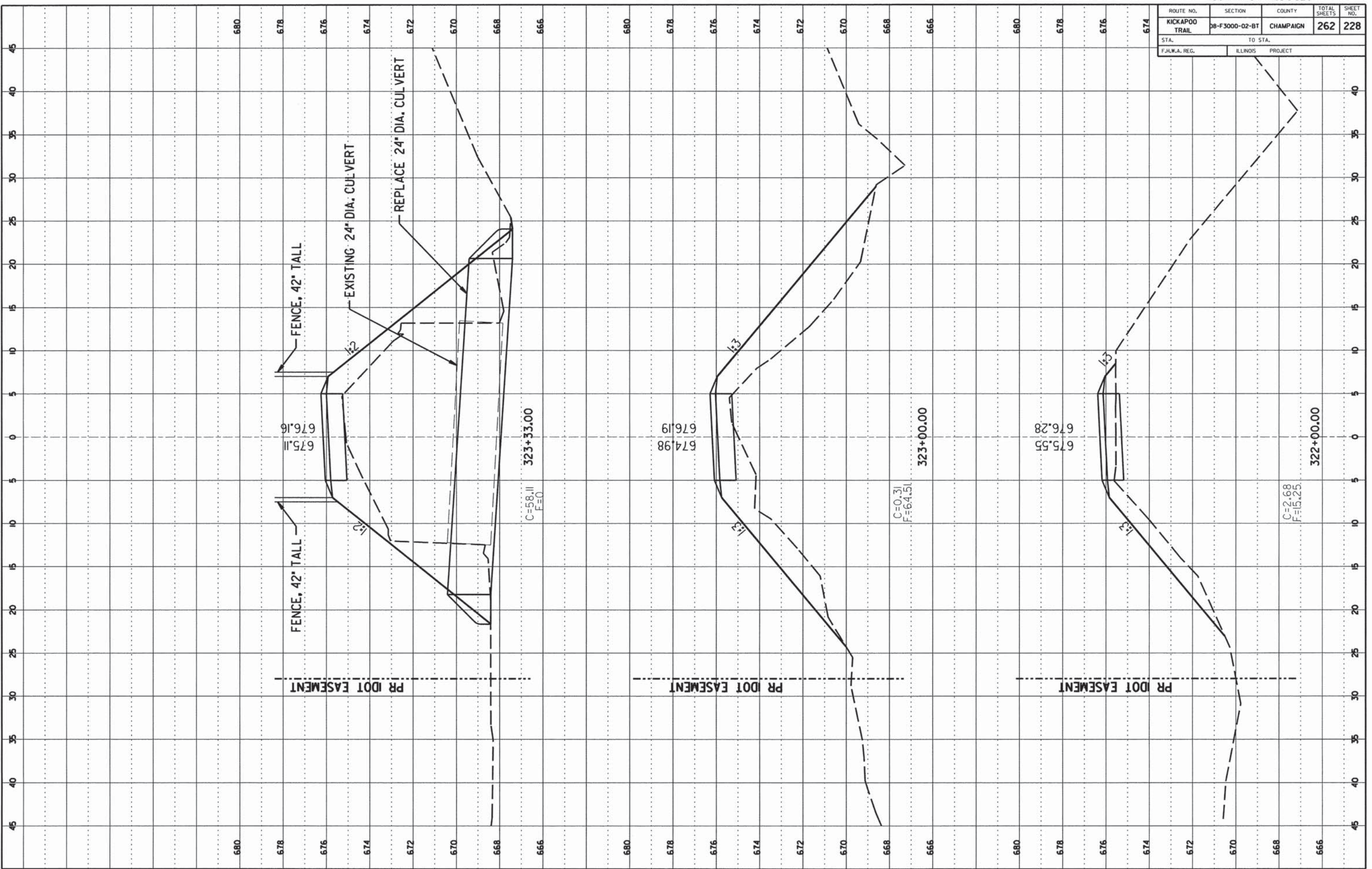

CCFPD KICKAPOO BIKE TRAIL CHAMPAIGN COUNTY

SHEET 228 OF 262 SHEETS 13-620A

CONTRACT NO. 91520

ROUTE NO.	SECTION	COUNTY	TOTAL SHEETS	SHEET NO.
KICKAPOO TRAIL	DB-F3000-02-BT	CHAMPAIGN	262	229
STA. TO STA.		ILLINOIS PROJECT		
F.I.L.W.A. REG.				

DATE	BY	SP

FINAL SURVEY  
 SWITTED  
 SURVEY  
 PARTED  
 NOTE BOOK  
 NO. \_\_\_\_\_  
 AREA ACROSS

DATE	BY	SP

ORIGINAL SURVEY  
 SWITTED  
 SURVEY  
 PARTED  
 NOTE BOOK  
 NO. \_\_\_\_\_  
 AREA ACROSS

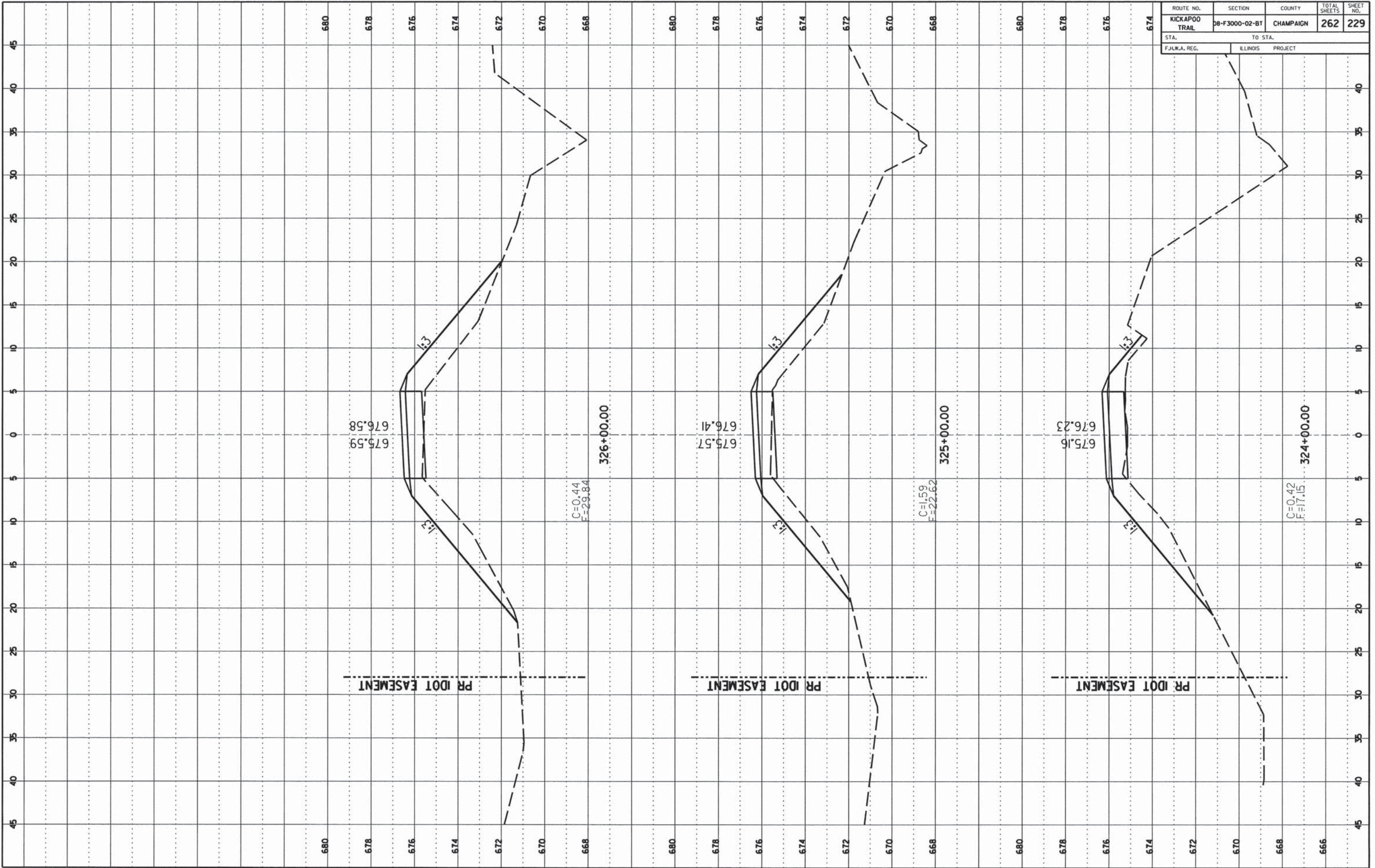

CCFPD KICKAPOO BIKE TRAIL

CHAMPAIGN COUNTY

SHEET 229 OF 262 SHEETS 13-620A



CONTRACT NO. 91520

ROUTE NO.	SECTION	COUNTY	TOTAL SHEETS	SHEET NO.
KICKAPOO TRAIL	08-F3000-02-BT	CHAMPAIGN	262	230
STA.	TO STA.			
F.H.W.A. REG.	ILLINOIS	PROJECT		

FINAL SURVEY  
 NO. \_\_\_\_\_  
 DATE \_\_\_\_\_

ORIGINAL SURVEY  
 NO. \_\_\_\_\_  
 DATE \_\_\_\_\_

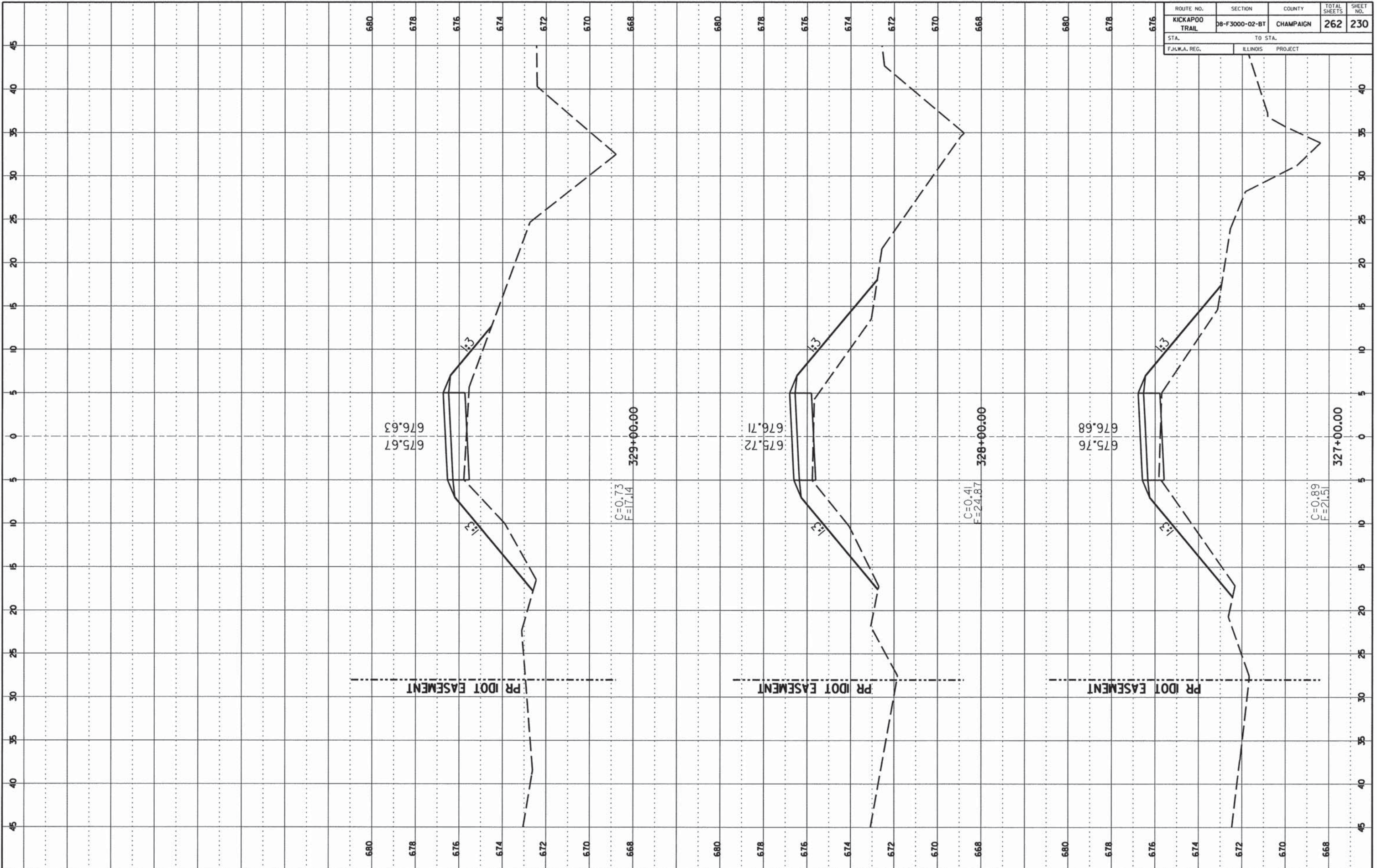

C=0.73  
 F=17.14  
 329+00.00

C=0.41  
 F=24.87  
 328+00.00

C=0.89  
 F=21.51  
 327+00.00

PR IDOT EASEMENT

PR IDOT EASEMENT

PR IDOT EASEMENT

CONTRACT NO. 91520

ROUTE NO.	SECTION	COUNTY	TOTAL SHEETS	SHEET NO.
KICKAPOO TRAIL	08-F3000-02-BT	CHAMPAIGN	262	231
STA. TO STA.		ILLINOIS PROJECT		
F.H.W.A. REG.				

FINAL SURVEY

DATE: \_\_\_\_\_ BY: \_\_\_\_\_

NO. \_\_\_\_\_

ORIGINAL SURVEY

DATE: \_\_\_\_\_ BY: \_\_\_\_\_

NO. \_\_\_\_\_

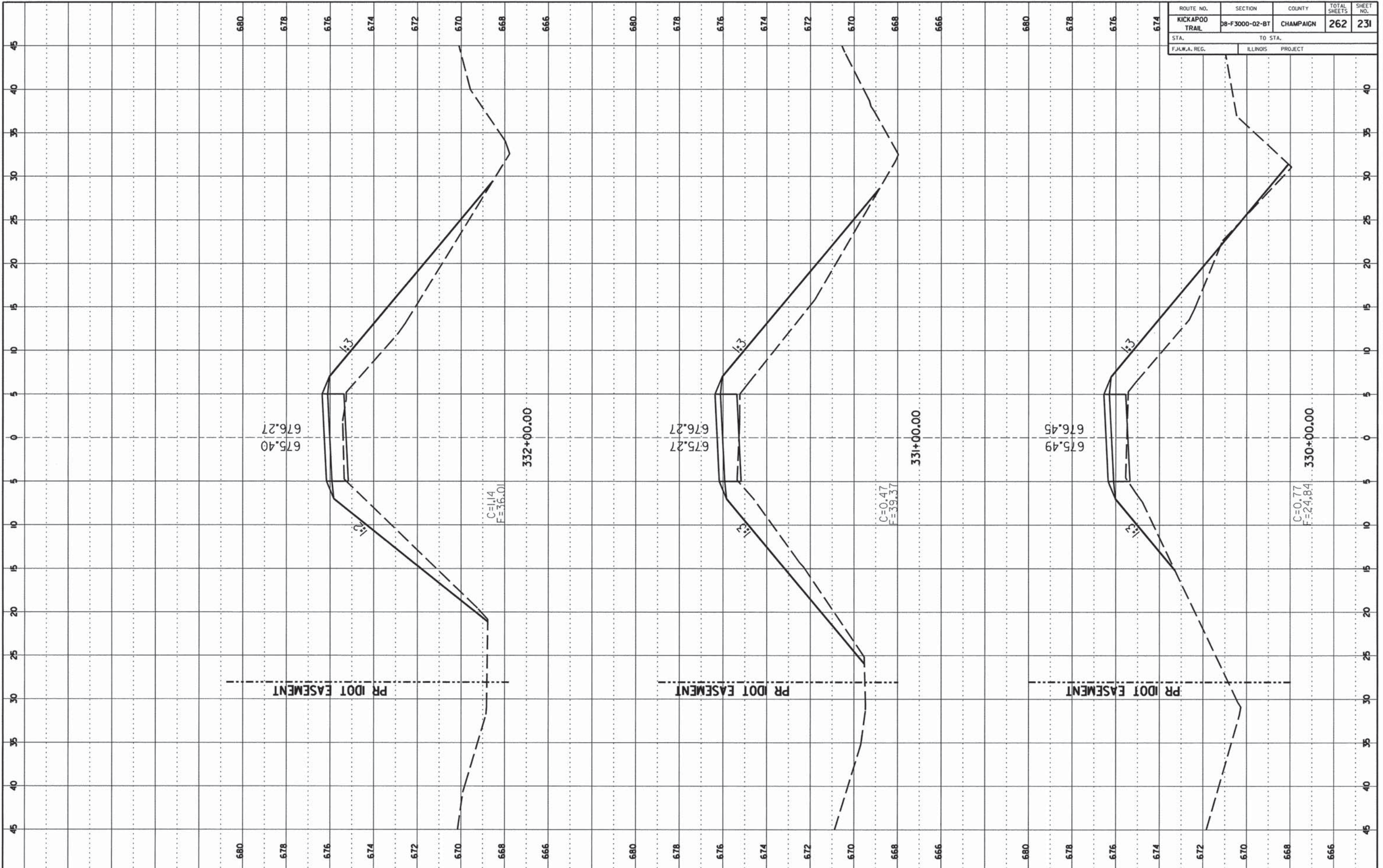

CONTRACT NO. 91520

ROUTE NO.	SECTION	COUNTY	TOTAL SHEETS	SHEET NO.
KICKAPOO TRAIL	DB-F3000-02-BT	CHAMPAIGN	262	232
STA.	TO STA.			
F.H.W.A. REG.	ILLINOIS	PROJECT		

FINAL SURVEY

DATE	
BY	
PROJECT	
PLATTED	
TRIMMED	
NOTE BOOK NO.	
AREAS CHECKED	

ORIGINAL SURVEY

DATE	
BY	
PROJECT	
PLATTED	
TRIMMED	
NOTE BOOK NO.	
AREAS CHECKED	

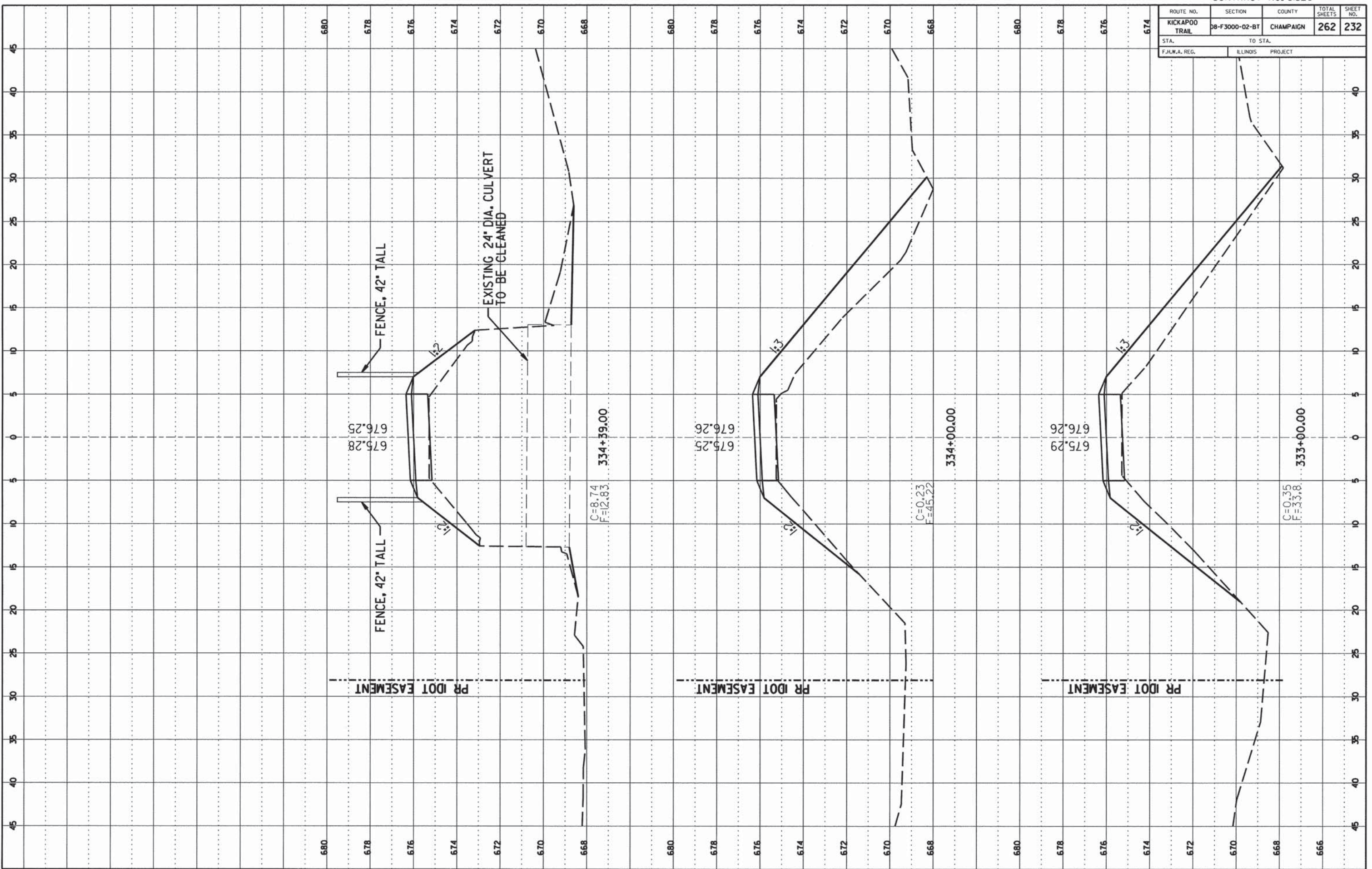

CCFPD KICKAPOO BIKE TRAIL

CHAMPAIGN COUNTY

SHEET 232 OF 262 SHEETS 13-620A



CONTRACT NO. 91520

ROUTE NO.	SECTION	COUNTY	TOTAL SHEETS	SHEET NO.
KICKAPOO TRAIL	08-F3000-02-BT	CHAMPAIGN	262	234
STA.	TO STA.			
F.H.W.A. REG.	ILLINOIS	PROJECT		

FINAL SURVEY

DATE: \_\_\_\_\_ BY: \_\_\_\_\_

NO. \_\_\_\_\_

APPROVED: \_\_\_\_\_

DATE: \_\_\_\_\_

ORIGINAL SURVEY

DATE: \_\_\_\_\_ BY: \_\_\_\_\_

NO. \_\_\_\_\_

APPROVED: \_\_\_\_\_

DATE: \_\_\_\_\_

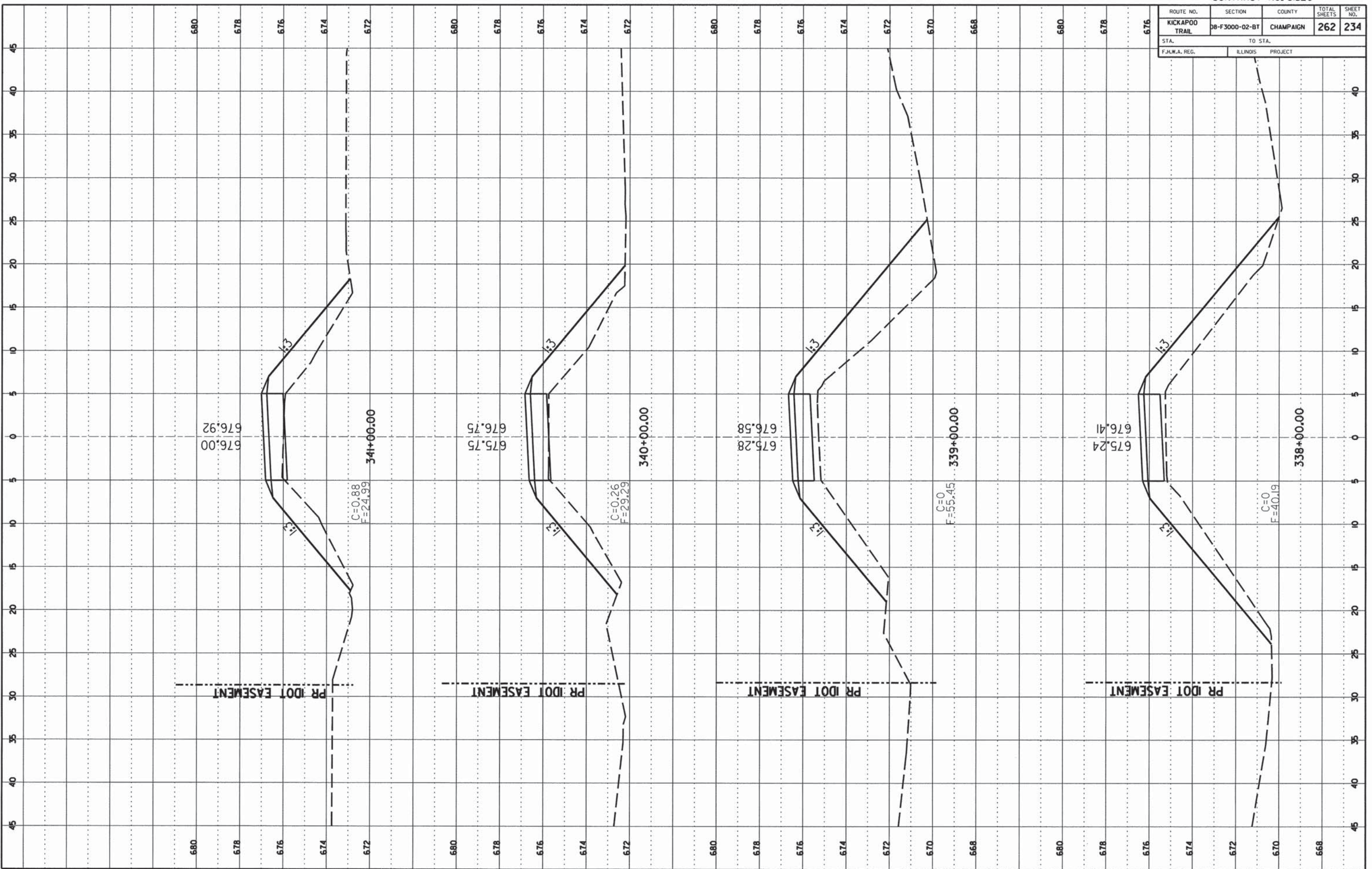

CCFPD KICKAPOO BIKE TRAIL CHAMPAIGN COUNTY

CONTRACT NO. 91520

ROUTE NO.	SECTION	COUNTY	TOTAL SHEETS	SHEET NO.
KICKAPOO TRAIL	DB-F3000-02-BT	CHAMPAIGN	262	235
STA. TO STA.		ILLINOIS PROJECT		
F.H.W.A. REG.				

FINAL SURVEY

DATE: \_\_\_\_\_ BY: \_\_\_\_\_

NO. \_\_\_\_\_

ORIGINAL SURVEY

DATE: \_\_\_\_\_ BY: \_\_\_\_\_

NO. \_\_\_\_\_

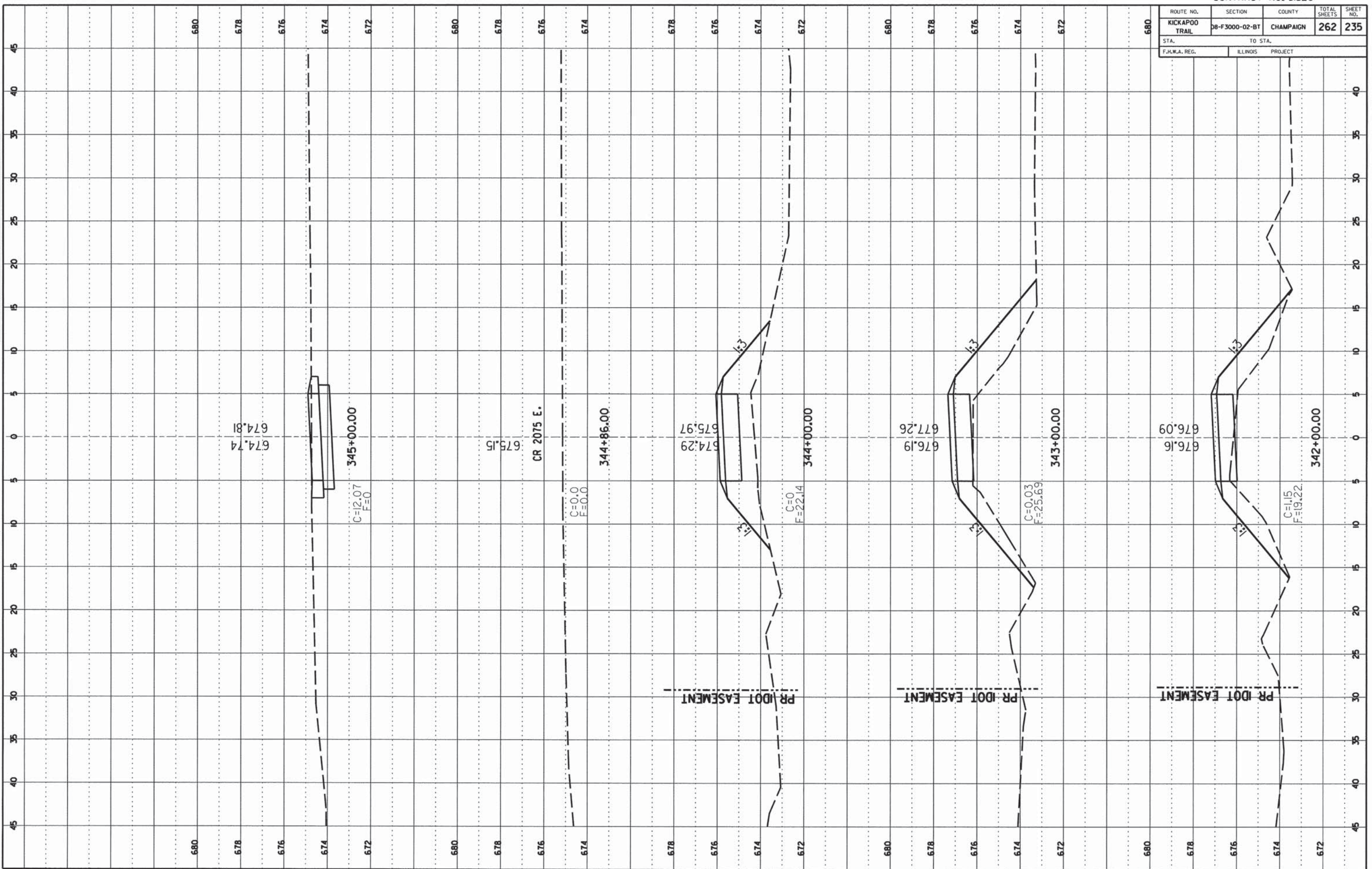

CONTRACT NO. 91520

ROUTE NO.	SECTION	COUNTY	TOTAL SHEETS	SHEET NO.
KICKAPOO TRAIL	08-F3000-02-BT	CHAMPAIGN	262	236
STA.		TO STA.		
F.H.W.A. REG.		ILLINOIS PROJECT		

FINAL SURVEY  
 NO. \_\_\_\_\_  
 DATE \_\_\_\_\_

ORIGINAL SURVEY  
 NO. \_\_\_\_\_  
 DATE \_\_\_\_\_

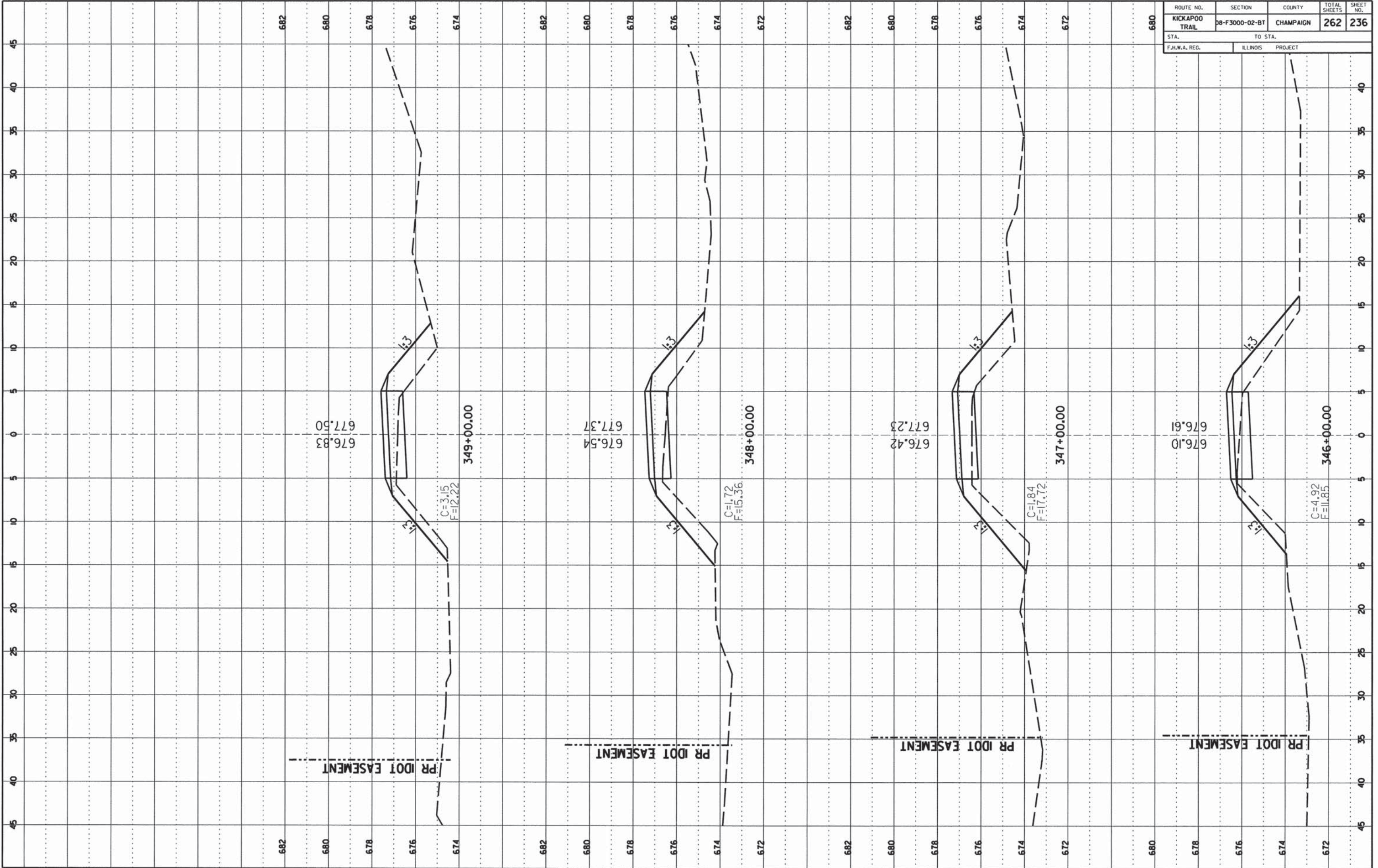

CONTRACT NO. 91520

ROUTE NO.	SECTION	COUNTY	TOTAL SHEETS	SHEET NO.
KICKAPOO TRAIL	08-F3000-02-B1	CHAMPAIGN	262	237
STA. TO STA.		ILLINOIS PROJECT		
F.H.W.A. REG.				

FINAL SURVEY

DATE: \_\_\_\_\_ BY: \_\_\_\_\_

NO. \_\_\_\_\_

SPICER: \_\_\_\_\_

PLATT: \_\_\_\_\_

TRIMM: \_\_\_\_\_

AREAS: \_\_\_\_\_

ORIGINAL SURVEY

DATE: \_\_\_\_\_ BY: \_\_\_\_\_

NO. \_\_\_\_\_

SPICER: \_\_\_\_\_

PLATT: \_\_\_\_\_

TRIMM: \_\_\_\_\_

AREAS: \_\_\_\_\_

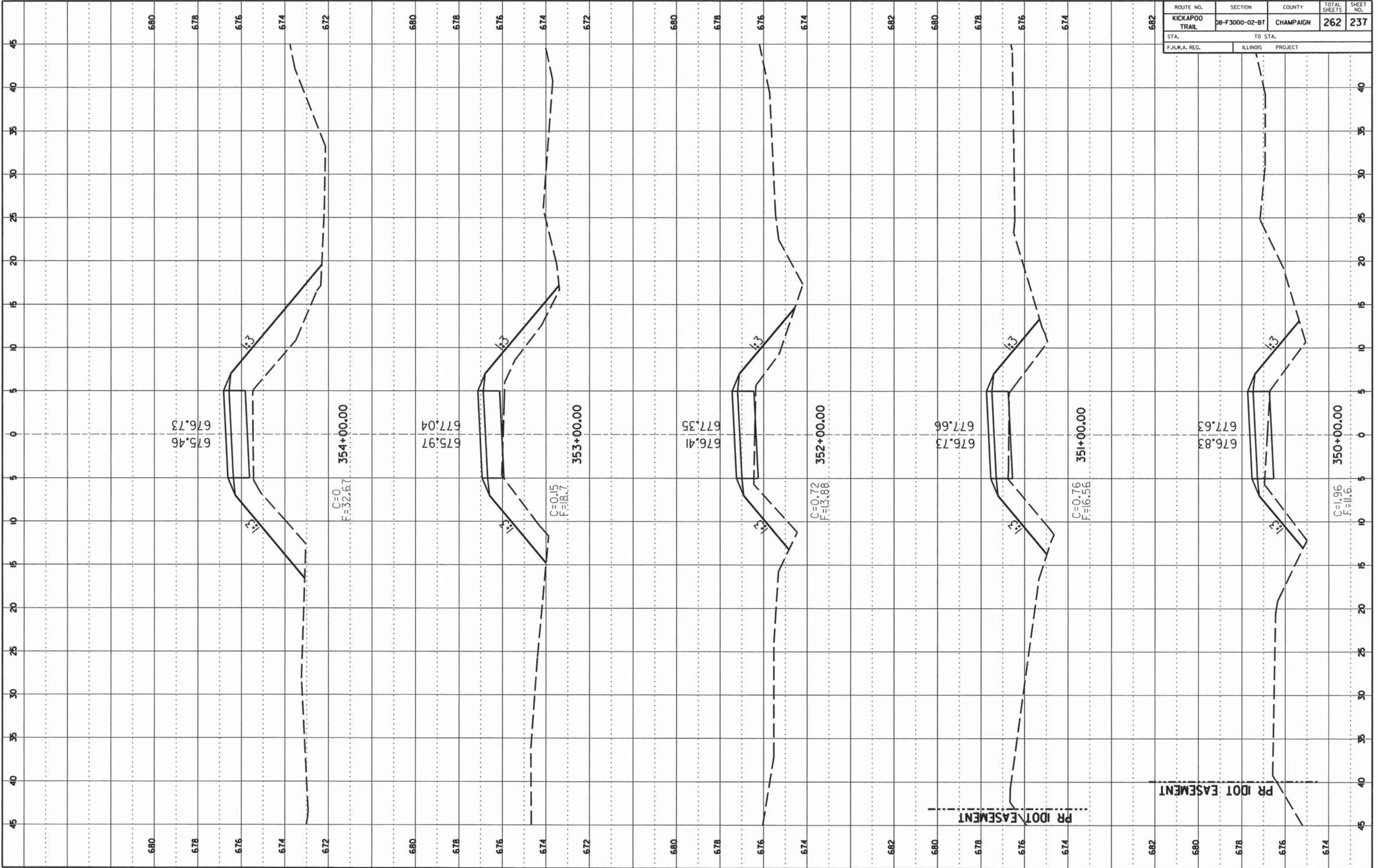

CCFPD KICKAPOO BIKE TRAIL

CHAMPAIGN COUNTY

SHEET 237 OF 262 SHEETS 13-620A



CONTRACT NO. 91520

ROUTE NO.	SECTION	COUNTY	TOTAL SHEETS	SHEET NO.
KICKAPOO TRAIL	DB-F3000-02-BT	CHAMPAIGN	262	238
STA. F.H.W.A. REG.		TO STA. ILLINOIS PROJECT		

FINAL SURVEY  
 NO. \_\_\_\_\_  
 DATE \_\_\_\_\_

ORIGINAL SURVEY  
 NO. \_\_\_\_\_  
 DATE \_\_\_\_\_

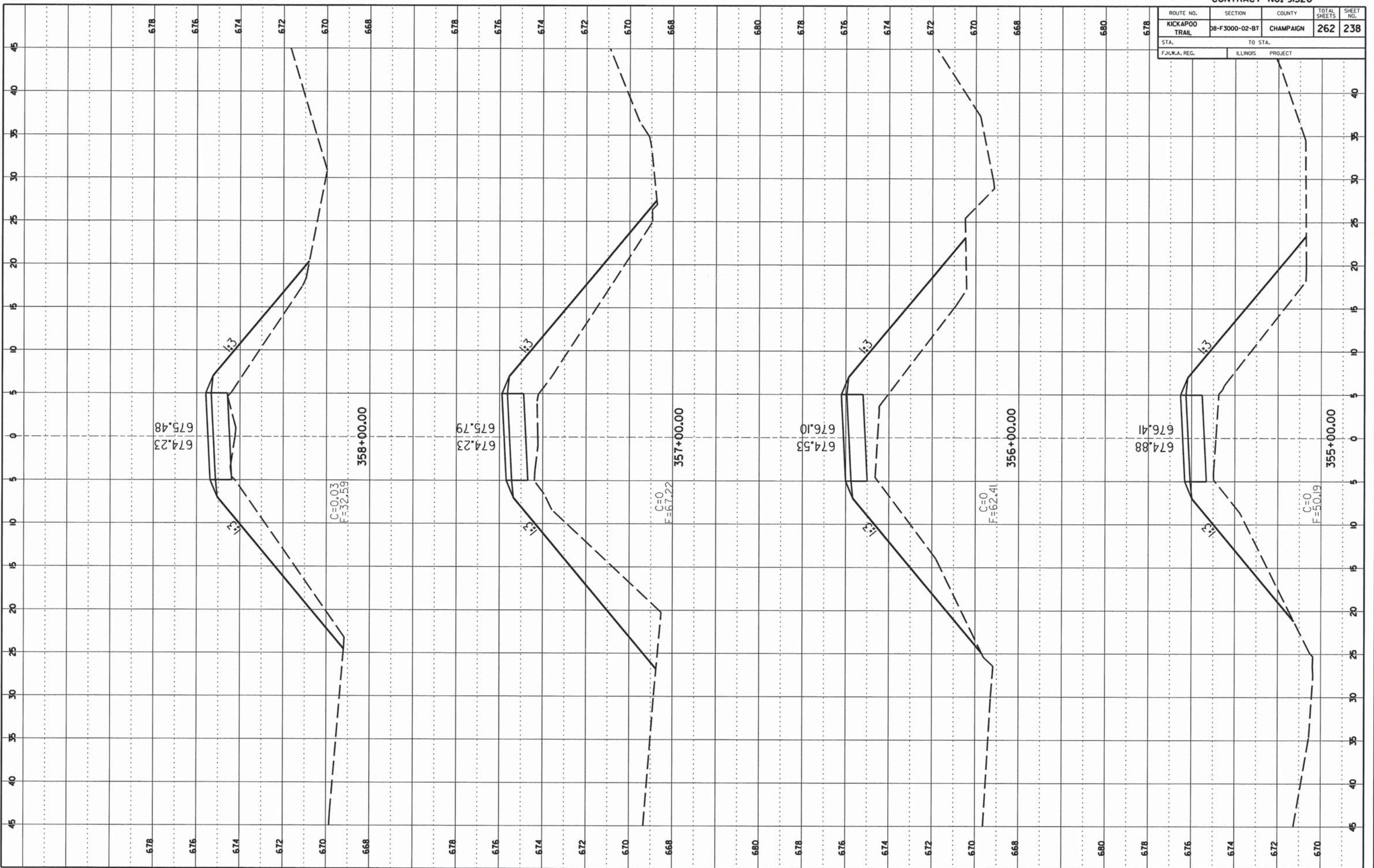

CCFPD KICKAPOO BIKE TRAIL CHAMPAIGN COUNTY

CONTRACT NO. 91520

ROUTE NO.	SECTION	COUNTY	TOTAL SHEETS	SHEET NO.
KICKAPOO TRAIL	08-F3000-02-BT	CHAMPAIGN	262	239
STA.	TO STA.			
F.H.W.A. REG.	ILLINOIS	PROJECT		

FINAL SURVEY	
DATE	BY
NO.	NO.
NO.	NO.
NO.	NO.
NO.	NO.

ORIGINAL SURVEY	
DATE	BY
NO.	NO.
NO.	NO.
NO.	NO.
NO.	NO.

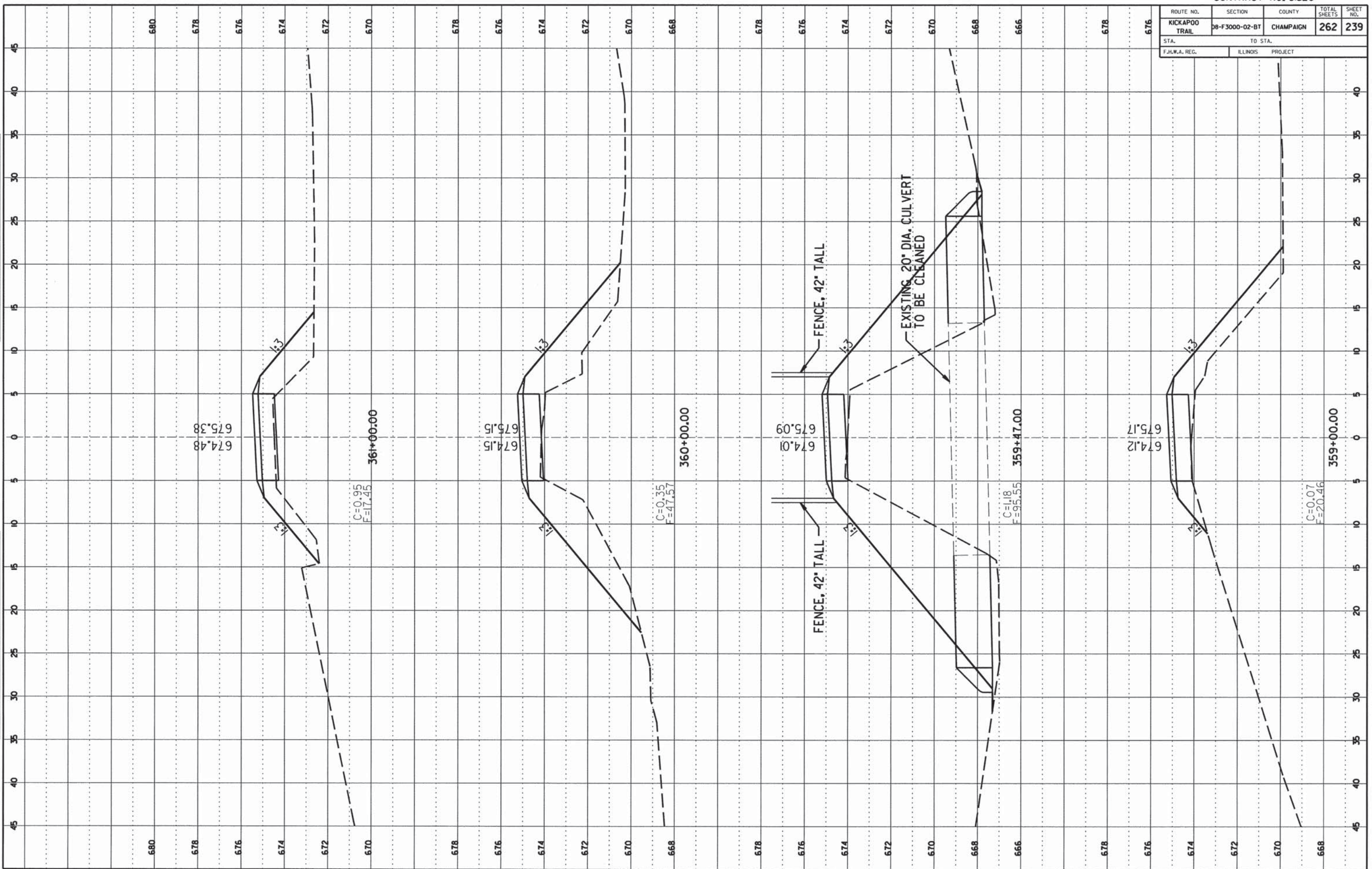

CCFPD KICKAPOO BIKE TRAIL CHAMPAIGN COUNTY

SHEET 239 OF 262 SHEETS 13-620A

CONTRACT NO. 91520

ROUTE NO.	SECTION	COUNTY	TOTAL SHEETS	SHEET NO.
KICKAPOO TRAIL	08-F3000-02-BT	CHAMPAIGN	262	240
STA. F.H.W.A. REG.		TO STA. ILLINOIS PROJECT		

FINAL SURVEY

DATE: \_\_\_\_\_

BY: \_\_\_\_\_

PROJECT: \_\_\_\_\_

PLANT: \_\_\_\_\_

NOTE BOOK NO.: \_\_\_\_\_

DATE: \_\_\_\_\_

BY: \_\_\_\_\_

PROJECT: \_\_\_\_\_

PLANT: \_\_\_\_\_

NOTE BOOK NO.: \_\_\_\_\_

ORIGINAL SURVEY

DATE: \_\_\_\_\_

BY: \_\_\_\_\_

PROJECT: \_\_\_\_\_

PLANT: \_\_\_\_\_

NOTE BOOK NO.: \_\_\_\_\_

DATE: \_\_\_\_\_

BY: \_\_\_\_\_

PROJECT: \_\_\_\_\_

PLANT: \_\_\_\_\_

NOTE BOOK NO.: \_\_\_\_\_

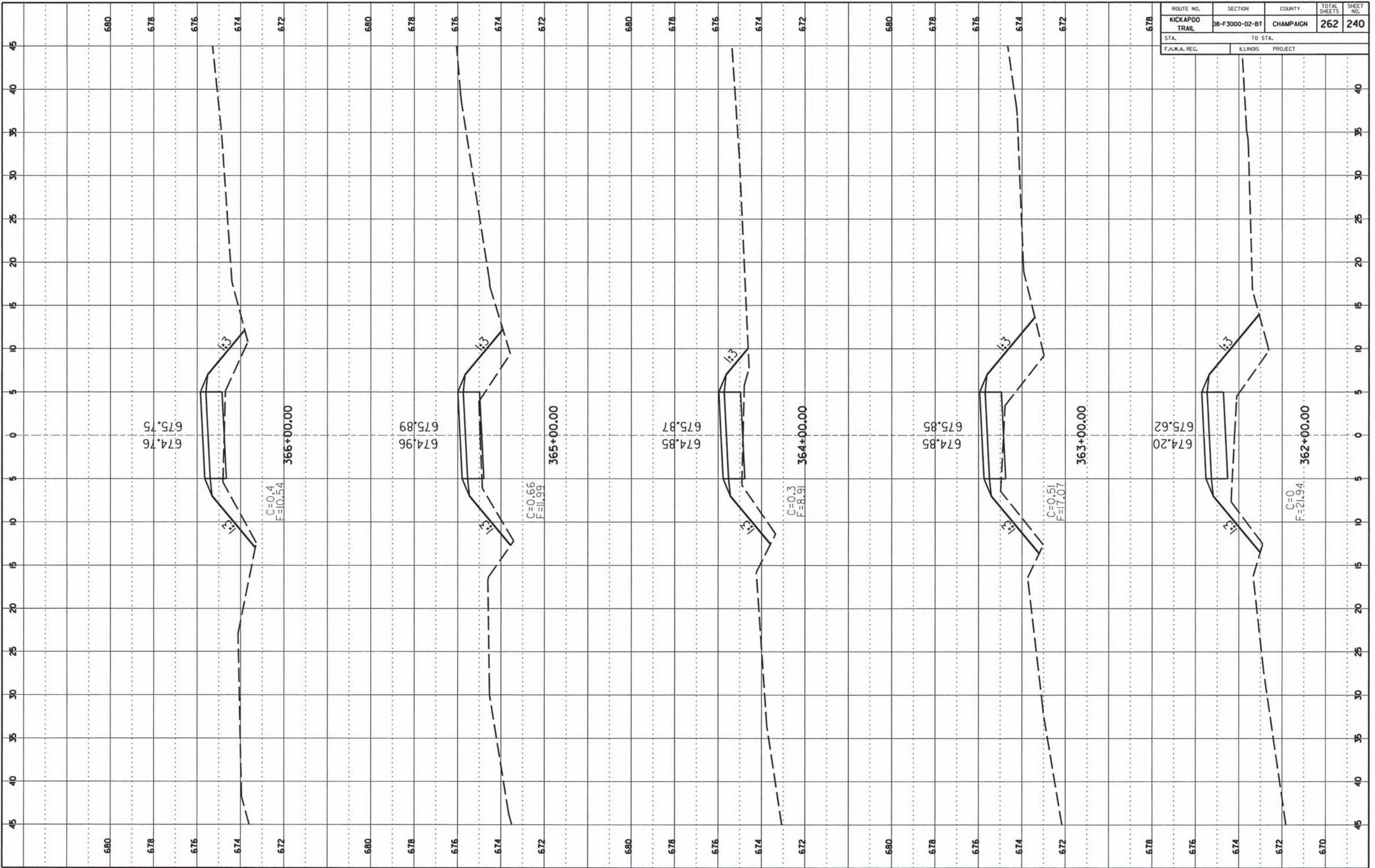

CCFPD KICKAPOO BIKE TRAIL

CHAMPAIGN COUNTY

SHEET 240 OF 262 SHEETS 13-620A

CONTRACT NO. 91520

ROUTE NO.	SECTION	COUNTY	TOTAL SHEETS	SHEET NO.
KICKAPOO TRAIL	08-F3000-02-BT	CHAMPAIGN	262	241
STA.	TO STA.			
F.H.W.A. REG.	ILLINOIS	PROJECT		

FINAL SURVEY

DATE	
BY	
REVISION	
NO.	

ORIGINAL SURVEY

DATE	
BY	
REVISION	
NO.	

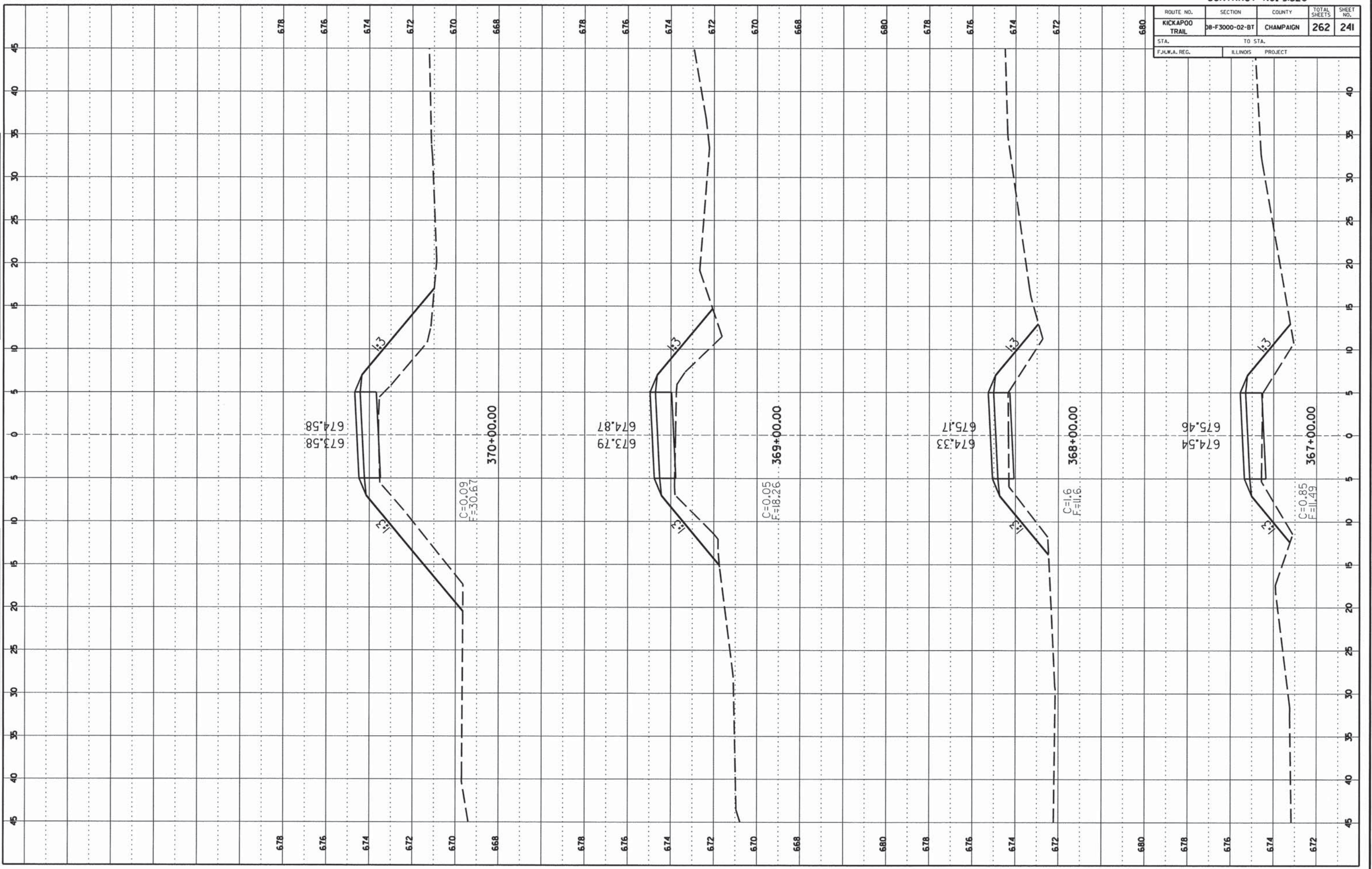

CONTRACT NO. 91520

ROUTE NO.	SECTION	COUNTY	TOTAL SHEETS	SHEET NO.
KICKAPOO TRAIL	DB-F3000-02-BT	CHAMPAIGN	262	242
STA. TO STA.		ILLINOIS PROJECT		
F.H.W.A. REG.				

FINAL SURVEY  
 DIRECTOR: \_\_\_\_\_  
 PLOTTED: \_\_\_\_\_  
 NOTE BOOK NO.: \_\_\_\_\_  
 DATE: \_\_\_\_\_

ORIGINAL SURVEY  
 DIRECTOR: \_\_\_\_\_  
 PLOTTED: \_\_\_\_\_  
 NOTE BOOK NO.: \_\_\_\_\_  
 DATE: \_\_\_\_\_

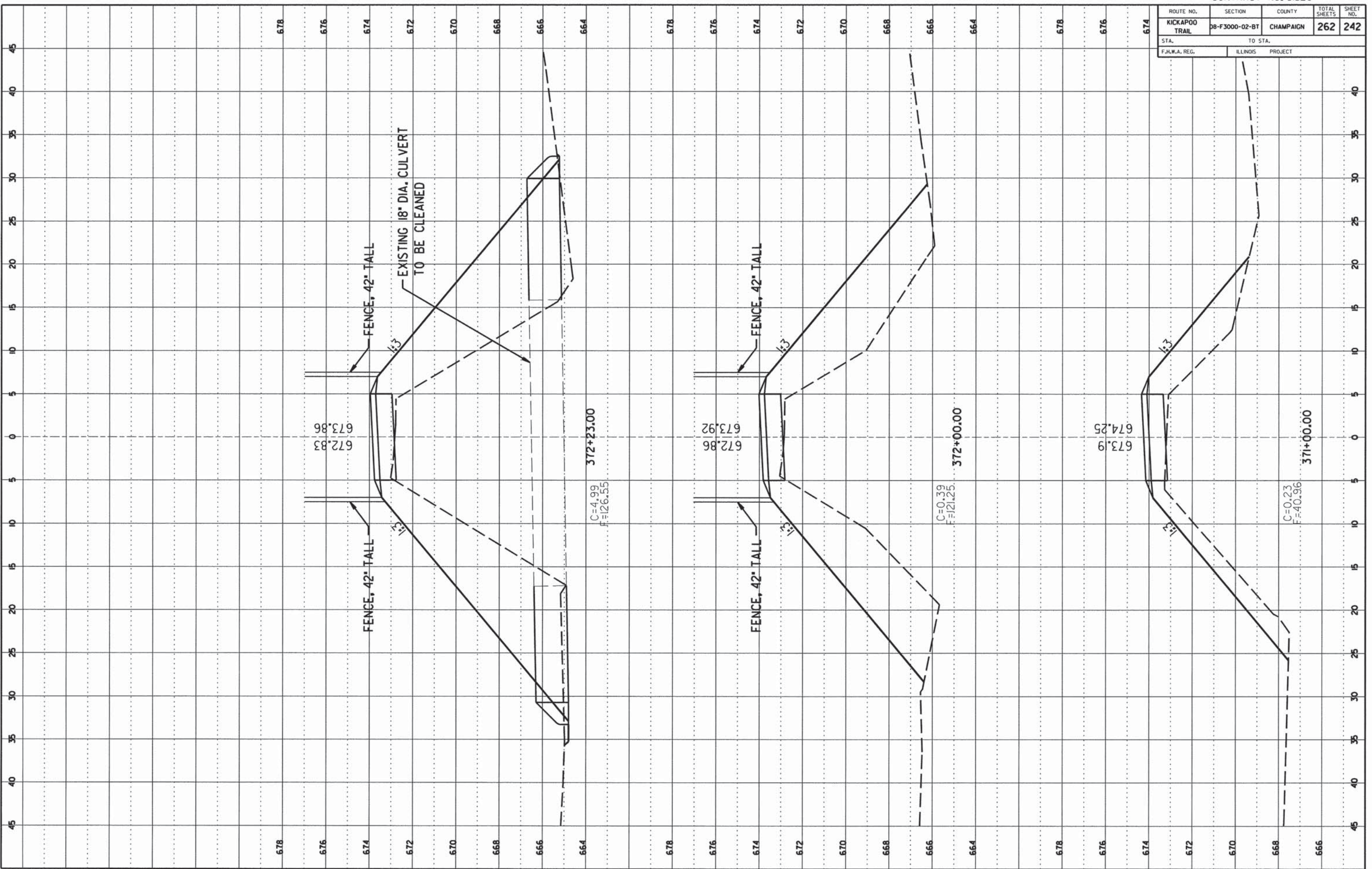

CCFPD KICKAPOO BIKE TRAIL

CHAMPAIGN COUNTY

SHEET 242 OF 262 SHEETS 13-620A

CONTRACT NO. 91520

ROUTE NO.	SECTION	COUNTY	TOTAL SHEETS	SHEET NO.
KICKAPOO TRAIL	08-F3000-02-BT	CHAMPAIGN	262	243
STA.	TO STA.			
F.I.L.W.A. REG.	ILLINOIS	PROJECT		

FINAL SURVEY

DATE: \_\_\_\_\_ BY: \_\_\_\_\_

NO. \_\_\_\_\_

SPICER  
PETER  
TIMOTHY  
JAMES

ORIGINAL SURVEY

DATE: \_\_\_\_\_ BY: \_\_\_\_\_

NO. \_\_\_\_\_

SPICER  
PETER  
TIMOTHY  
JAMES

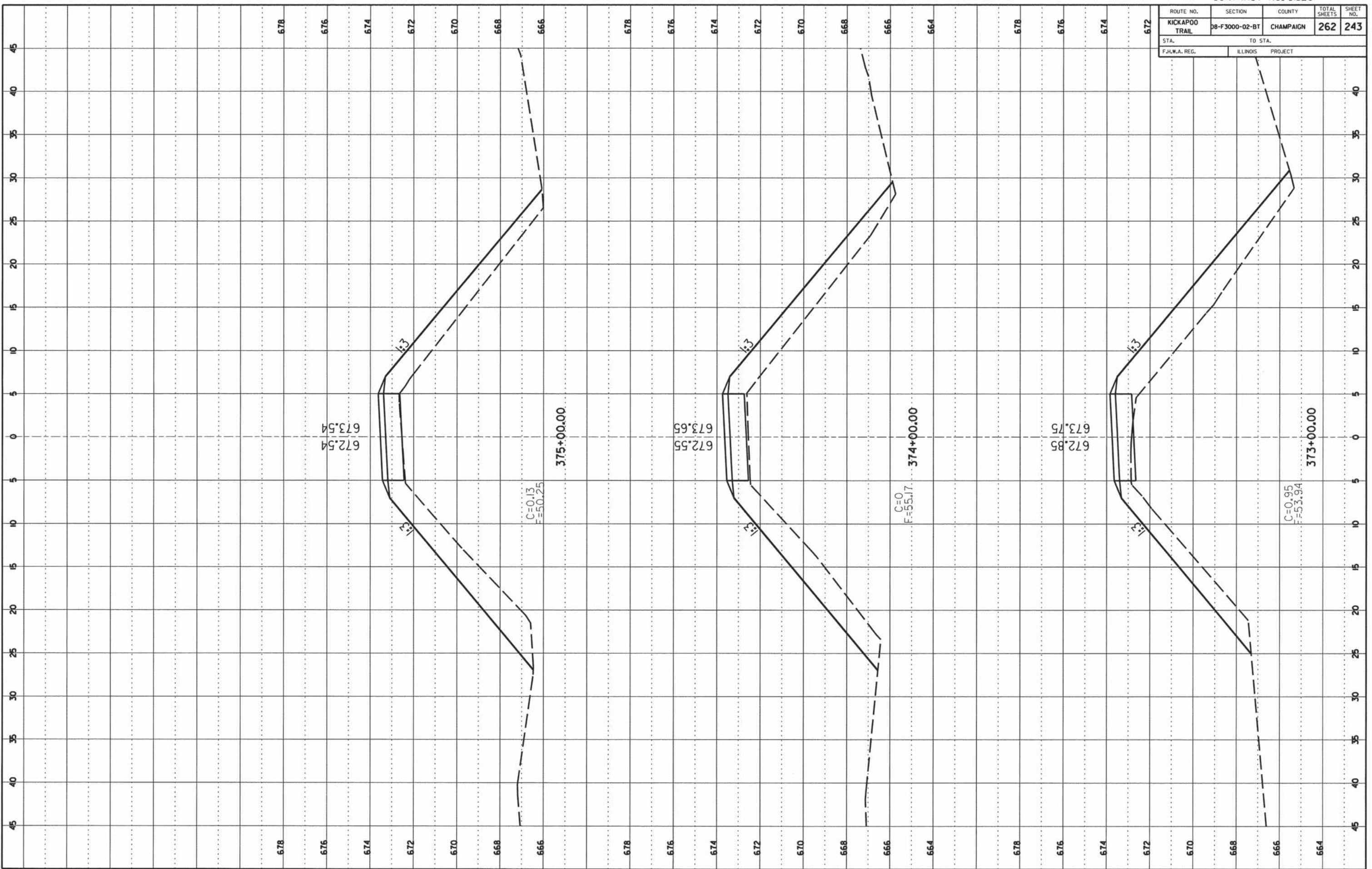

CCFPD KICKAPOO BIKE TRAIL

CHAMPAIGN COUNTY

SHEET 243 OF 262 SHEETS 13-620A

CONTRACT NO. 91520

ROUTE NO.	SECTION	COUNTY	TOTAL SHEETS	SHEET NO.
KICKAPOO TRAIL	DB-F3000-02-BT	CHAMPAIGN	262	244
STA.		TO STA.		
F.H.W.A. REG.		ILLINOIS PROJECT		

DATE	BY

FINAL SURVEY  
NOTE BOOK NO. \_\_\_\_\_  
AREAS DELETED

DATE	BY

ORIGINAL SURVEY  
NOTE BOOK NO. \_\_\_\_\_  
AREAS DELETED

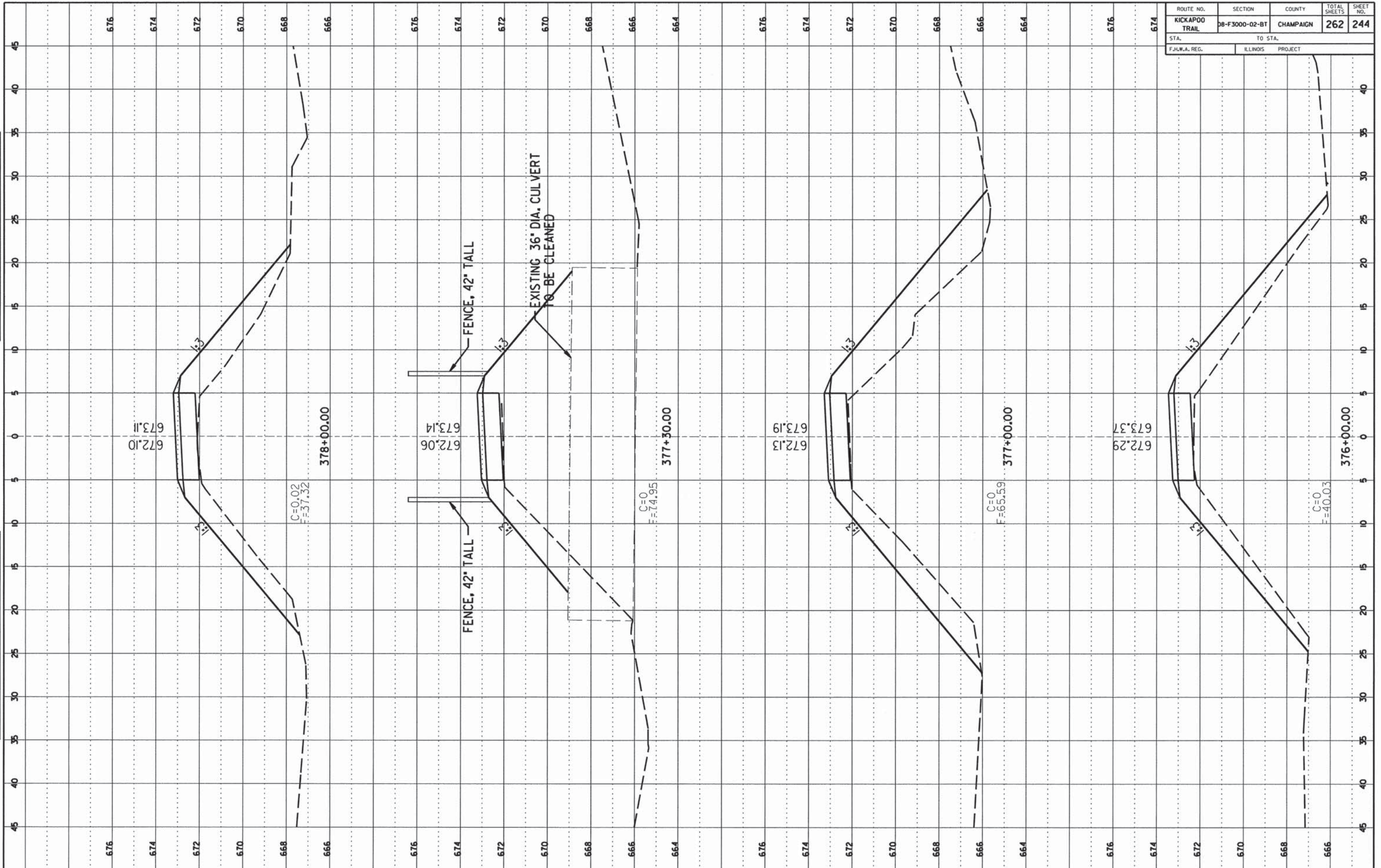

CCFPD KICKAPOO BIKE TRAIL CHAMPAIGN COUNTY

SHEET 244 OF 262 SHEETS 13-620A

CONTRACT NO. 91520

ROUTE NO.	SECTION	COUNTY	TOTAL SHEETS	SHEET NO.
KICKAPOO TRAIL	DB-F3000-02-BT	CHAMPAIGN	262	245
STA.	TO STA.			
F.H.W.A. REG.	ILLINOIS	PROJECT		

FINAL SURVEY

DATE: \_\_\_\_\_

BY: \_\_\_\_\_

NO. \_\_\_\_\_

DATE: \_\_\_\_\_

BY: \_\_\_\_\_

NO. \_\_\_\_\_

ORIGINAL SURVEY

DATE: \_\_\_\_\_

BY: \_\_\_\_\_

NO. \_\_\_\_\_

DATE: \_\_\_\_\_

BY: \_\_\_\_\_

NO. \_\_\_\_\_

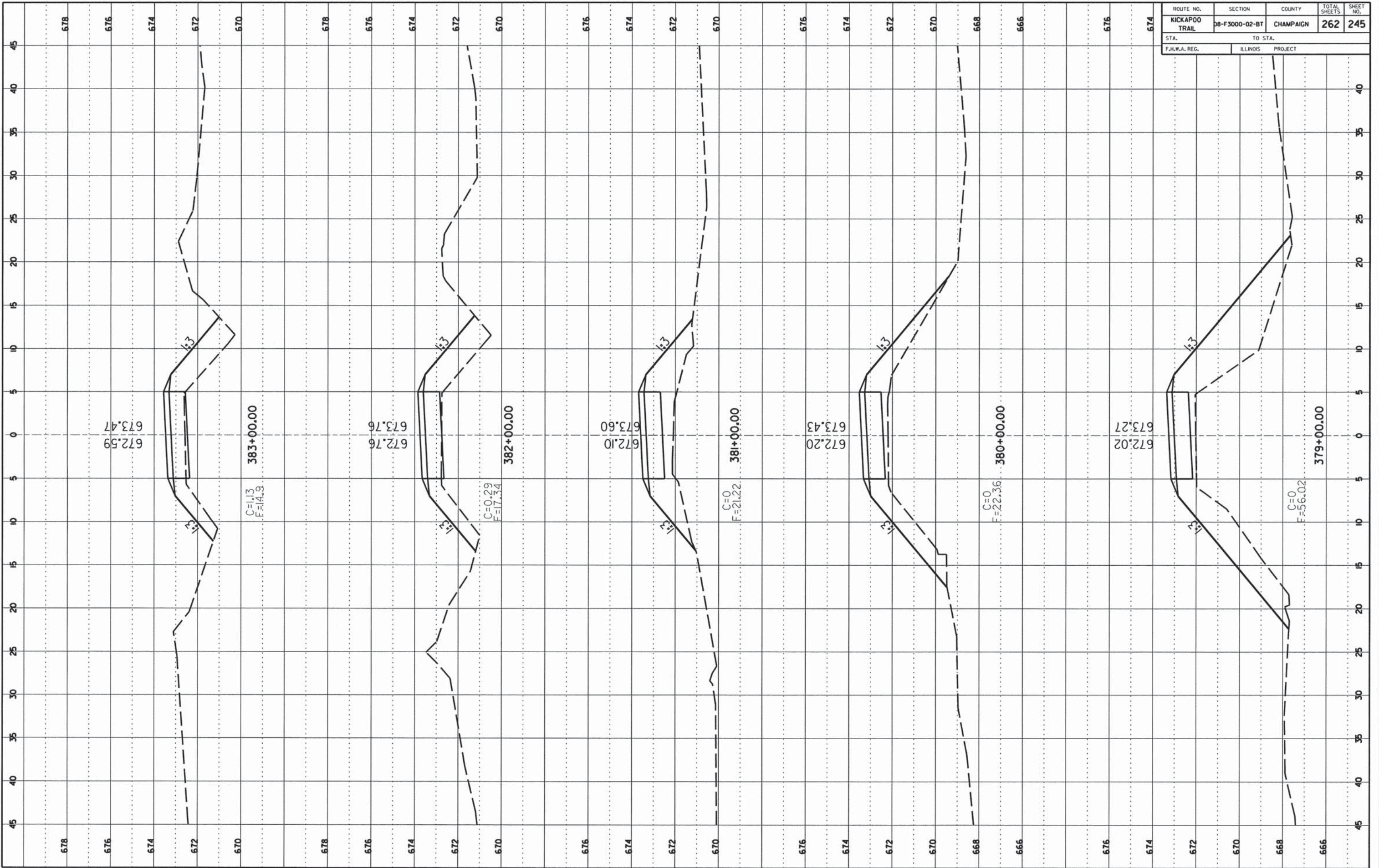



CONTRACT NO. 91520

ROUTE NO.	SECTION	COUNTY	TOTAL SHEETS	SHEET NO.
KICKAPOO TRAIL	08-F3000-02-BT	CHAMPAIGN	262	246
STA.	TO STA.			
F.H.W.A. REG.	ILLINOIS	PROJECT		

FINAL SURVEY

DATE: \_\_\_\_\_ BY: \_\_\_\_\_

NO. \_\_\_\_\_

NO. \_\_\_\_\_

NO. \_\_\_\_\_

NO. \_\_\_\_\_

NO. \_\_\_\_\_

ORIGINAL SURVEY

DATE: \_\_\_\_\_ BY: \_\_\_\_\_

NO. \_\_\_\_\_

NO. \_\_\_\_\_

NO. \_\_\_\_\_

NO. \_\_\_\_\_

NO. \_\_\_\_\_

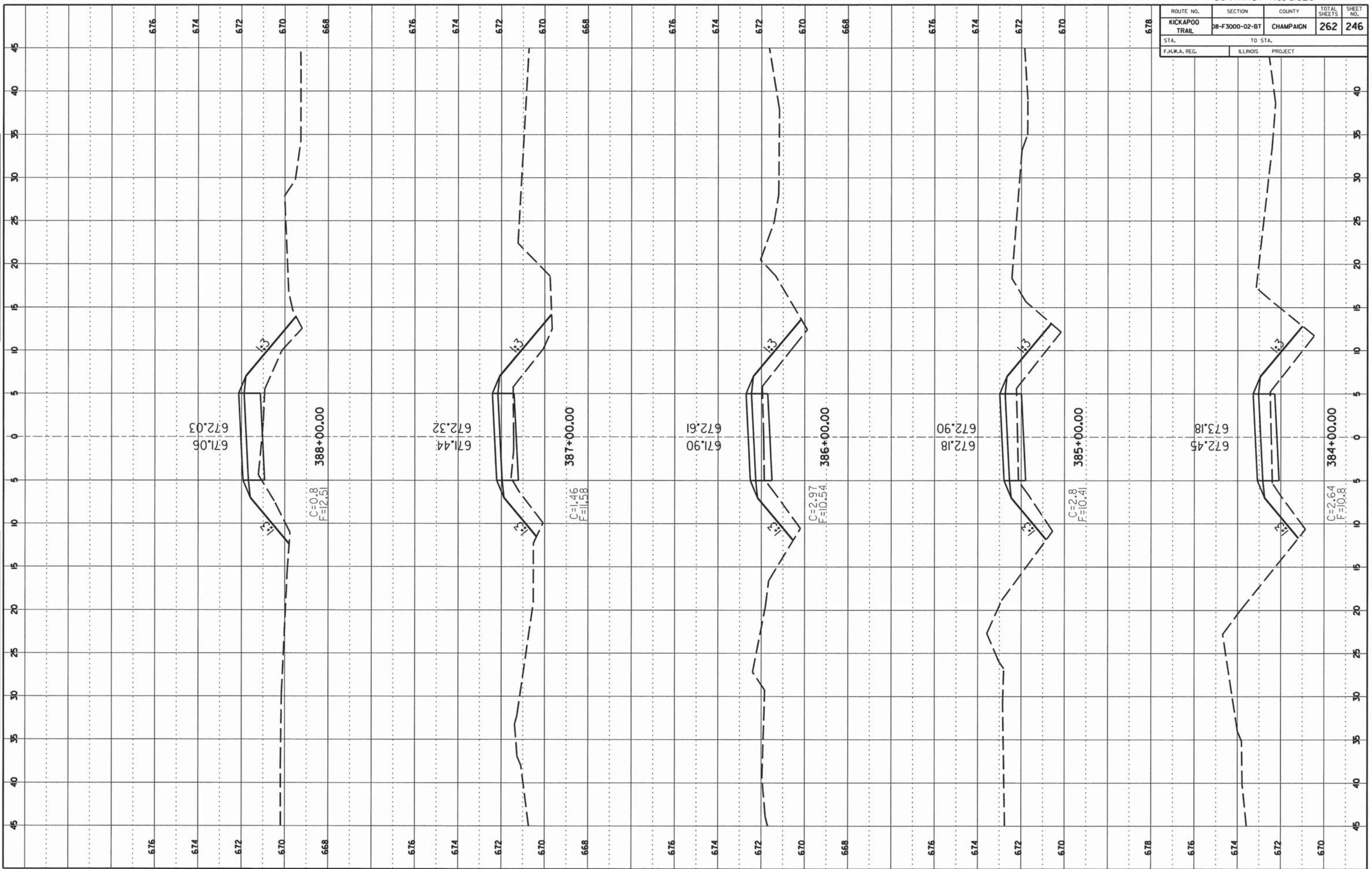

CCFPD KICKAPOO BIKE TRAIL

CHAMPAIGN COUNTY

SHEET 246 OF 262 SHEETS 13-620A

CONTRACT NO. 91520

ROUTE NO.	SECTION	COUNTY	TOTAL SHEETS	SHEET NO.
KICKAPOO TRAIL	08-F3000-02-BT	CHAMPAIGN	262	247
STA. TO STA.		PROJECT		
F.H.W.A. REG.		ILLINOIS		

FINAL SURVEY

DATE: \_\_\_\_\_

BY: \_\_\_\_\_

NO. \_\_\_\_\_

DATE: \_\_\_\_\_

BY: \_\_\_\_\_

NO. \_\_\_\_\_

ORIGINAL SURVEY

DATE: \_\_\_\_\_

BY: \_\_\_\_\_

NO. \_\_\_\_\_

DATE: \_\_\_\_\_

BY: \_\_\_\_\_

NO. \_\_\_\_\_

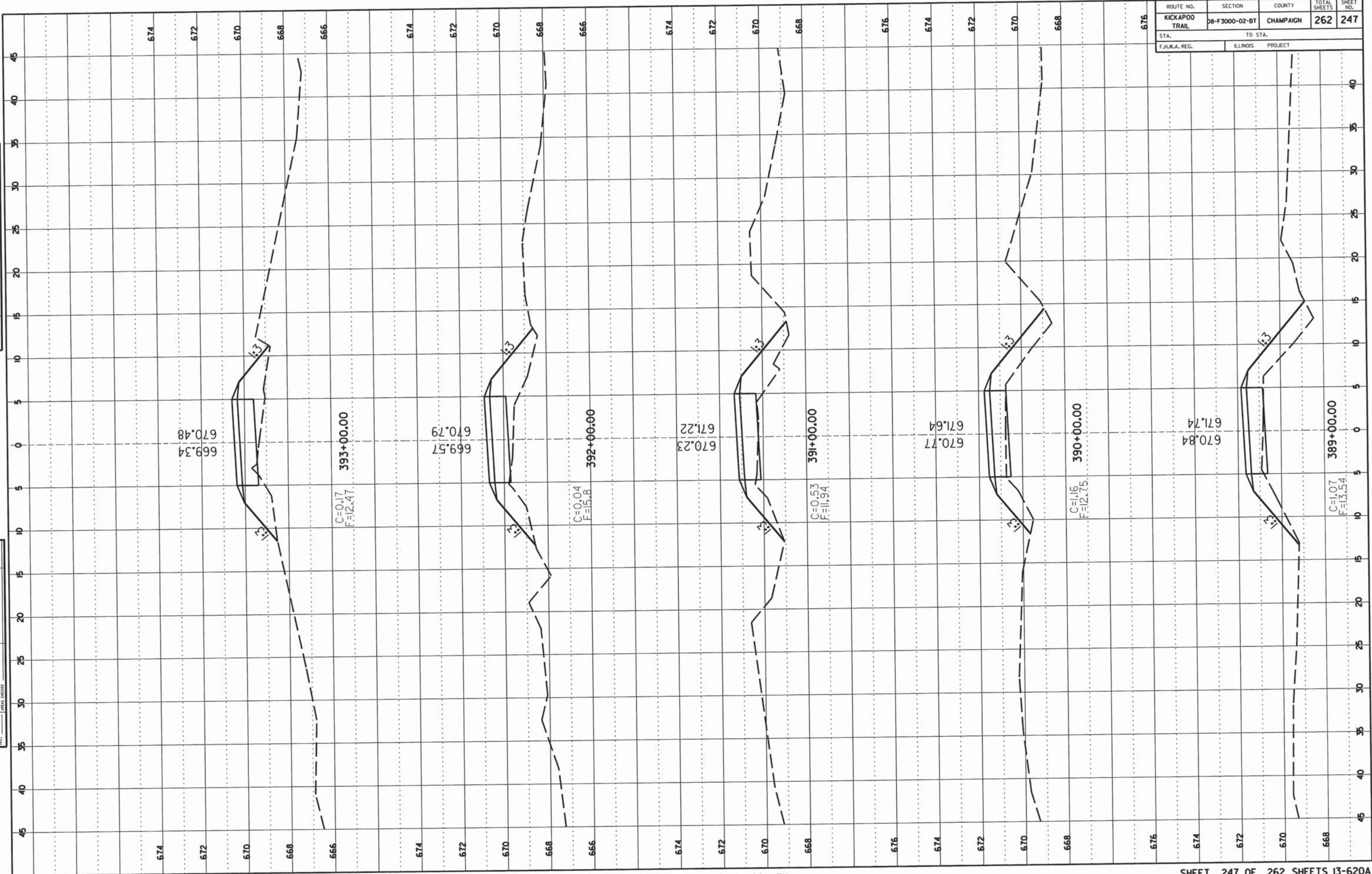

CCFPD KICKAPOO BIKE TRAIL CHAMPAIGN COUNTY

CONTRACT NO. 91520

ROUTE NO.	SECTION	COUNTY	TOTAL SHEETS	SHEET NO.
KICKAPOO TRAIL	08-F3000-02-BT	CHAMPAIGN	262	248
STA.	TO STA.			
F.H.W.A. REG.	ILLINOIS	PROJECT		

FINAL SURVEY  
 NO. \_\_\_\_\_  
 DATE \_\_\_\_\_

ORIGINAL SURVEY  
 NO. \_\_\_\_\_  
 DATE \_\_\_\_\_

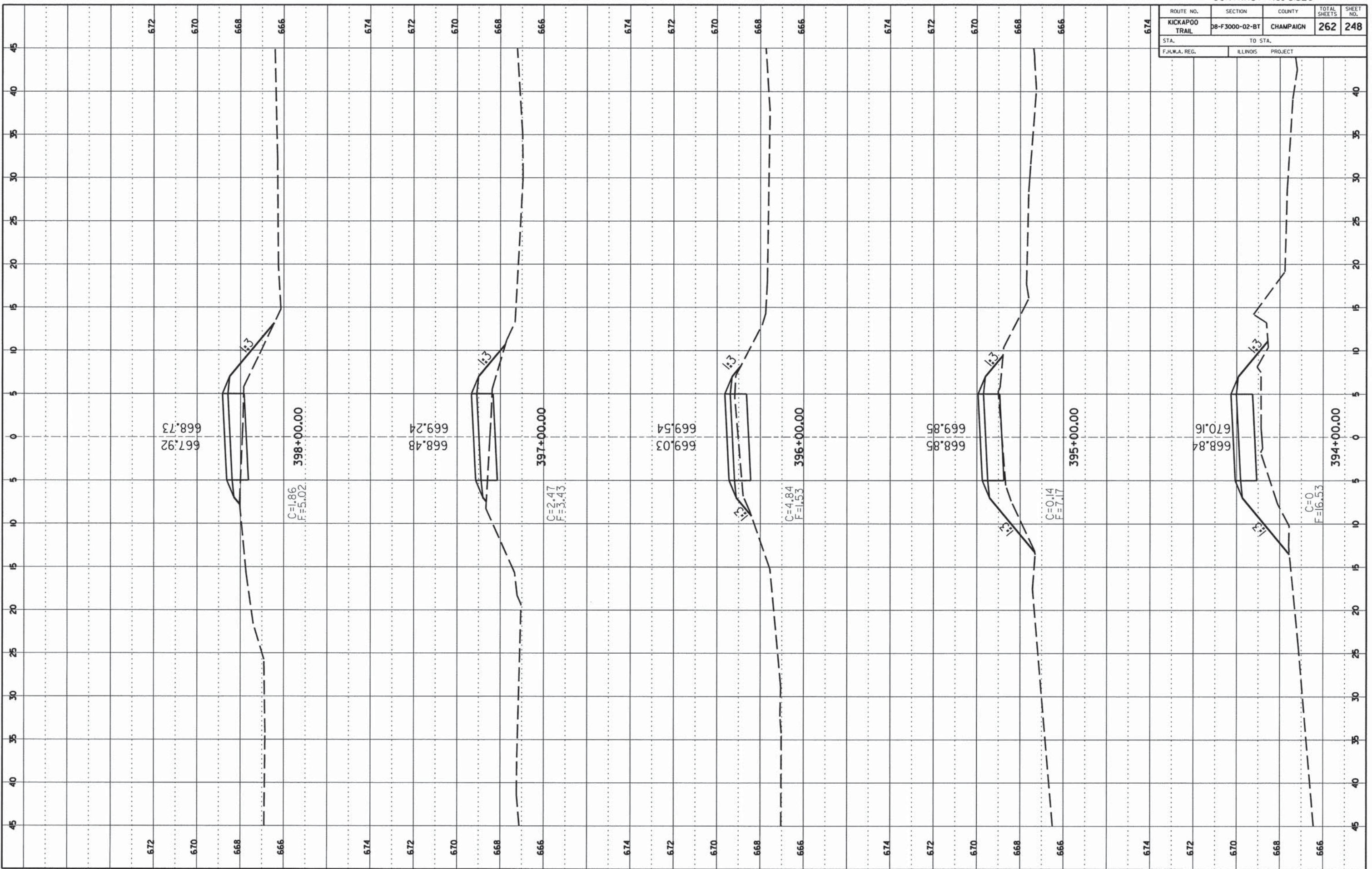

CCFPD KICKAPOO BIKE TRAIL

CHAMPAIGN COUNTY

SHEET 248 OF 262 SHEETS 13-620A

CONTRACT NO. 91520

ROUTE NO.	SECTION	COUNTY	TOTAL SHEETS	SHEET NO.
KICKAPOO TRAIL	DB-F3000-02-BT	CHAMPAIGN	262	249
STA.		TO STA.		
F.H.W.A. REG.		ILLINOIS PROJECT		

FINAL SURVEY	DATE
DATE	
BY	
REVISIONS	
NO.	
AREAS DELETED	
NOTE BOOK NO.	

ORIGINAL SURVEY	DATE
DATE	
BY	
REVISIONS	
NO.	
AREAS DELETED	
NOTE BOOK NO.	

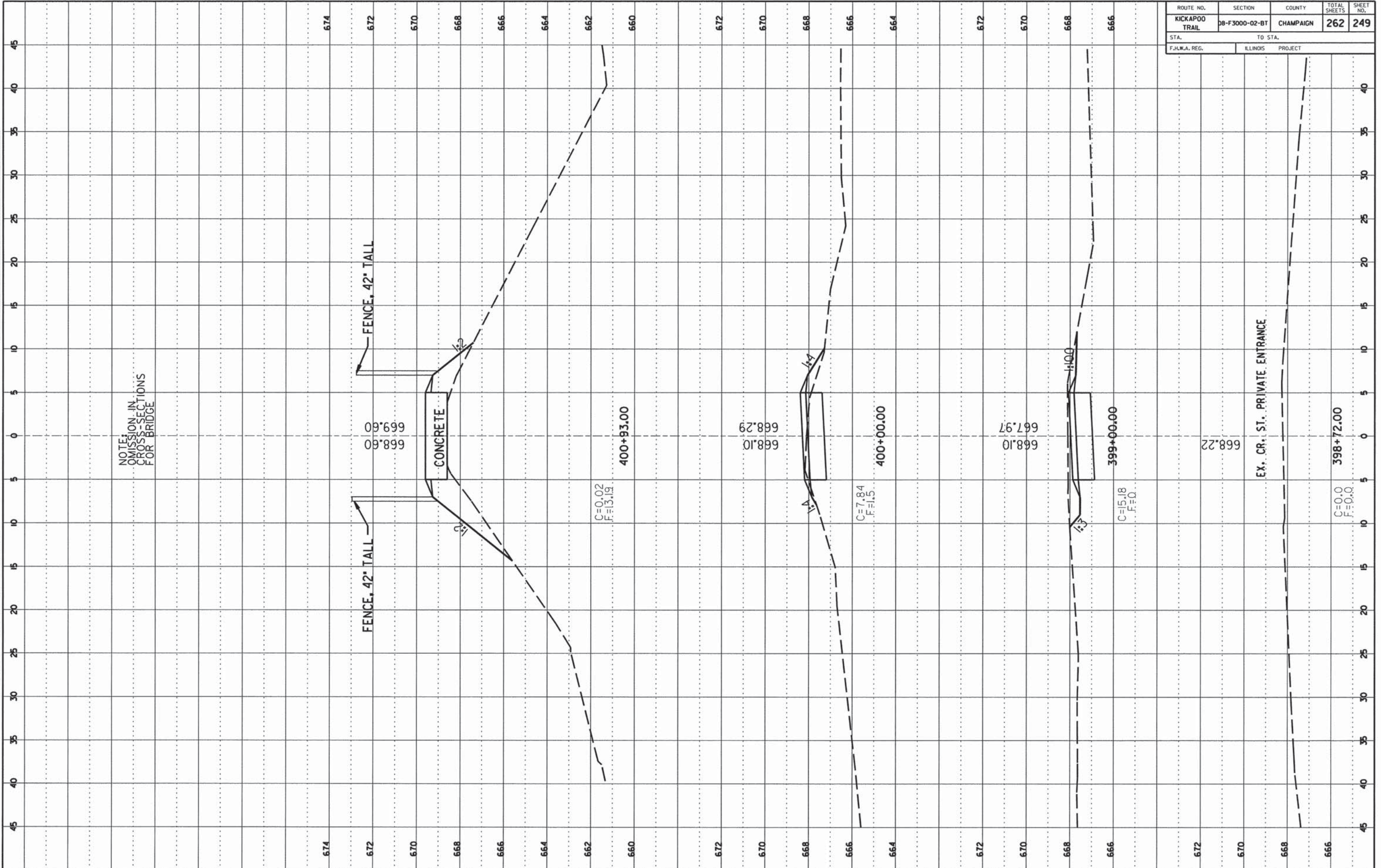

CONTRACT NO. 91520

ROUTE NO.	SECTION	COUNTY	TOTAL SHEETS	SHEET NO.
KICKAPOO TRAIL	08-F3000-02-BT	CHAMPAIGN	262	250
STA. TO STA.		ILLINOIS PROJECT		
F.H.W.A. REG.				

FINAL SURVEY

NO. \_\_\_\_\_

DATE \_\_\_\_\_

BY \_\_\_\_\_

APPROVED \_\_\_\_\_

DATE \_\_\_\_\_

ORIGINAL SURVEY

NO. \_\_\_\_\_

DATE \_\_\_\_\_

BY \_\_\_\_\_

APPROVED \_\_\_\_\_

DATE \_\_\_\_\_

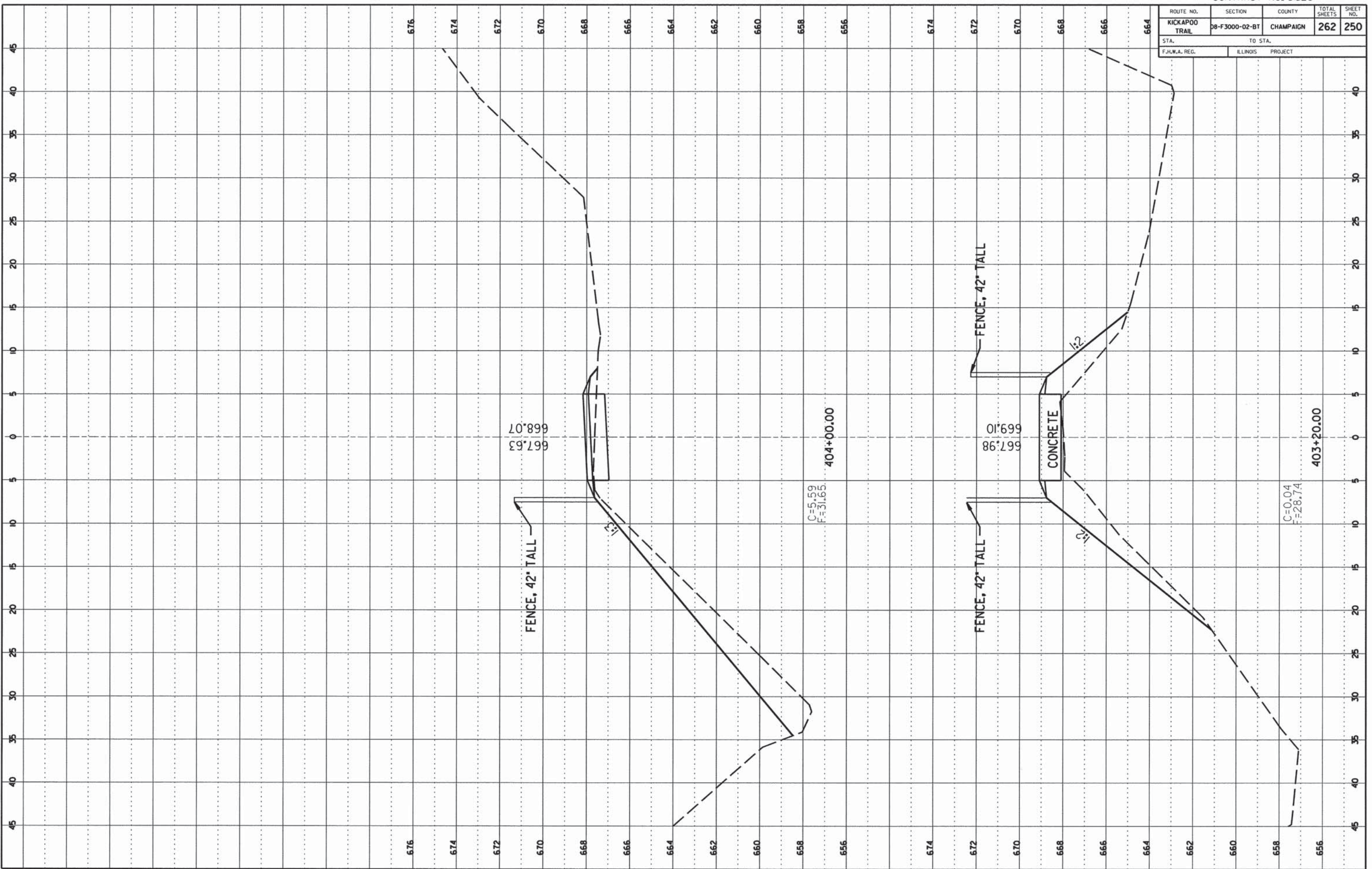

CONTRACT NO. 91520

ROUTE NO.	SECTION	COUNTY	TOTAL SHEETS	SHEET NO.
KICKAPOO TRAIL	08-F3000-02-BT	CHAMPAIGN	262	251
STA.		TO STA.		
F.I.L.W.A. REG.		ILLINOIS PROJECT		

NO.	DATE	BY

FINAL SURVEY  
 DRAWING NO. \_\_\_\_\_  
 DATE \_\_\_\_\_  
 BY \_\_\_\_\_  
 CHECKED \_\_\_\_\_  
 DATE \_\_\_\_\_  
 BY \_\_\_\_\_

NO.	DATE	BY

ORIGINAL SURVEY  
 DRAWING NO. \_\_\_\_\_  
 DATE \_\_\_\_\_  
 BY \_\_\_\_\_  
 CHECKED \_\_\_\_\_  
 DATE \_\_\_\_\_  
 BY \_\_\_\_\_

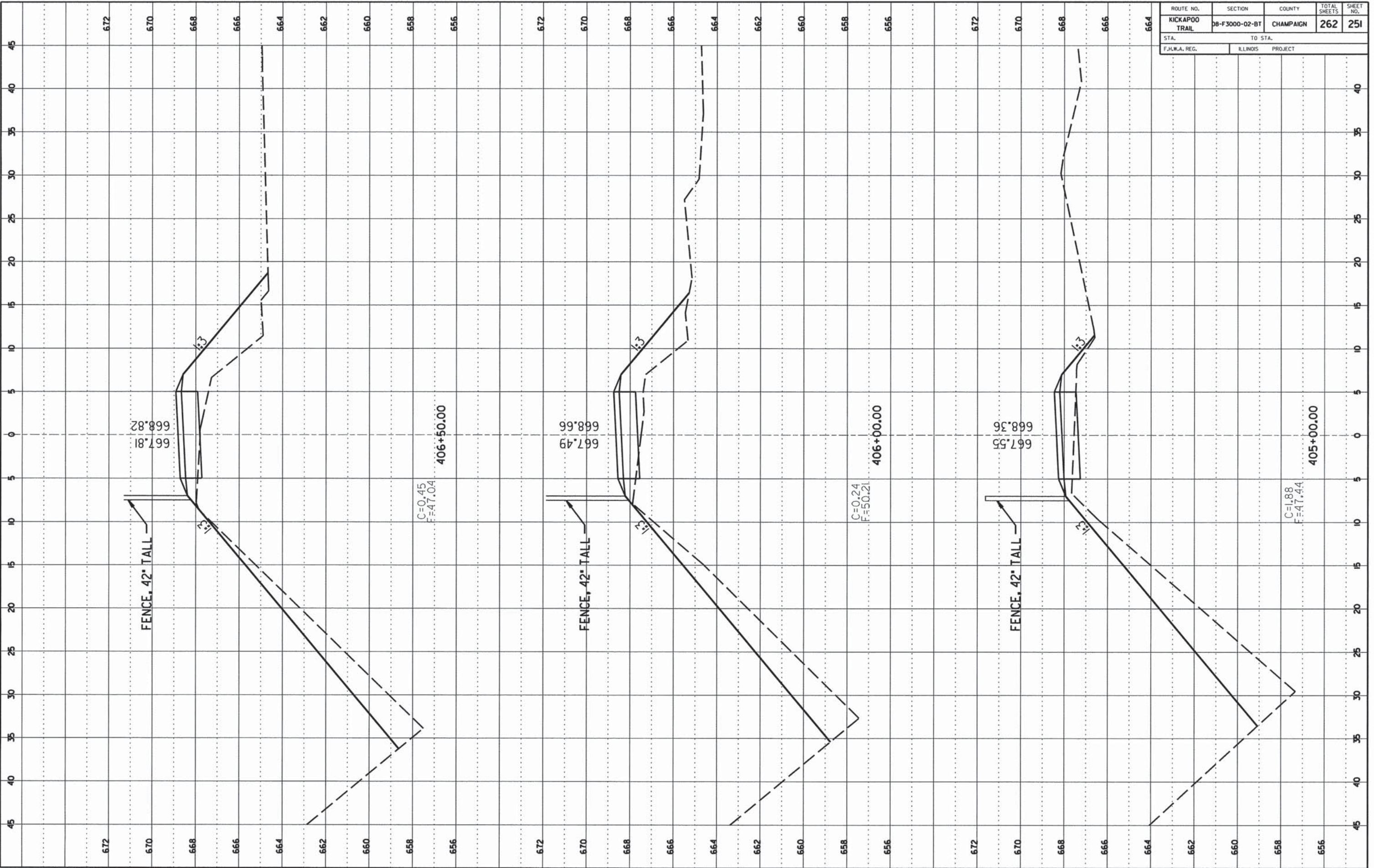

CONTRACT NO. 91520

ROUTE NO.	SECTION	COUNTY	TOTAL SHEETS	SHEET NO.
KICKAPOO TRAIL	08-F3000-02-BT	CHAMPAIGN	262	252
STA.	TO STA.			
F.H.W.A. REG.	ILLINOIS	PROJECT		

FINAL SURVEY

DATE: \_\_\_\_\_

BY: \_\_\_\_\_

NO. \_\_\_\_\_

AREAS CHECKED \_\_\_\_\_

ORIGINAL SURVEY

DATE: \_\_\_\_\_

BY: \_\_\_\_\_

NO. \_\_\_\_\_

AREAS CHECKED \_\_\_\_\_

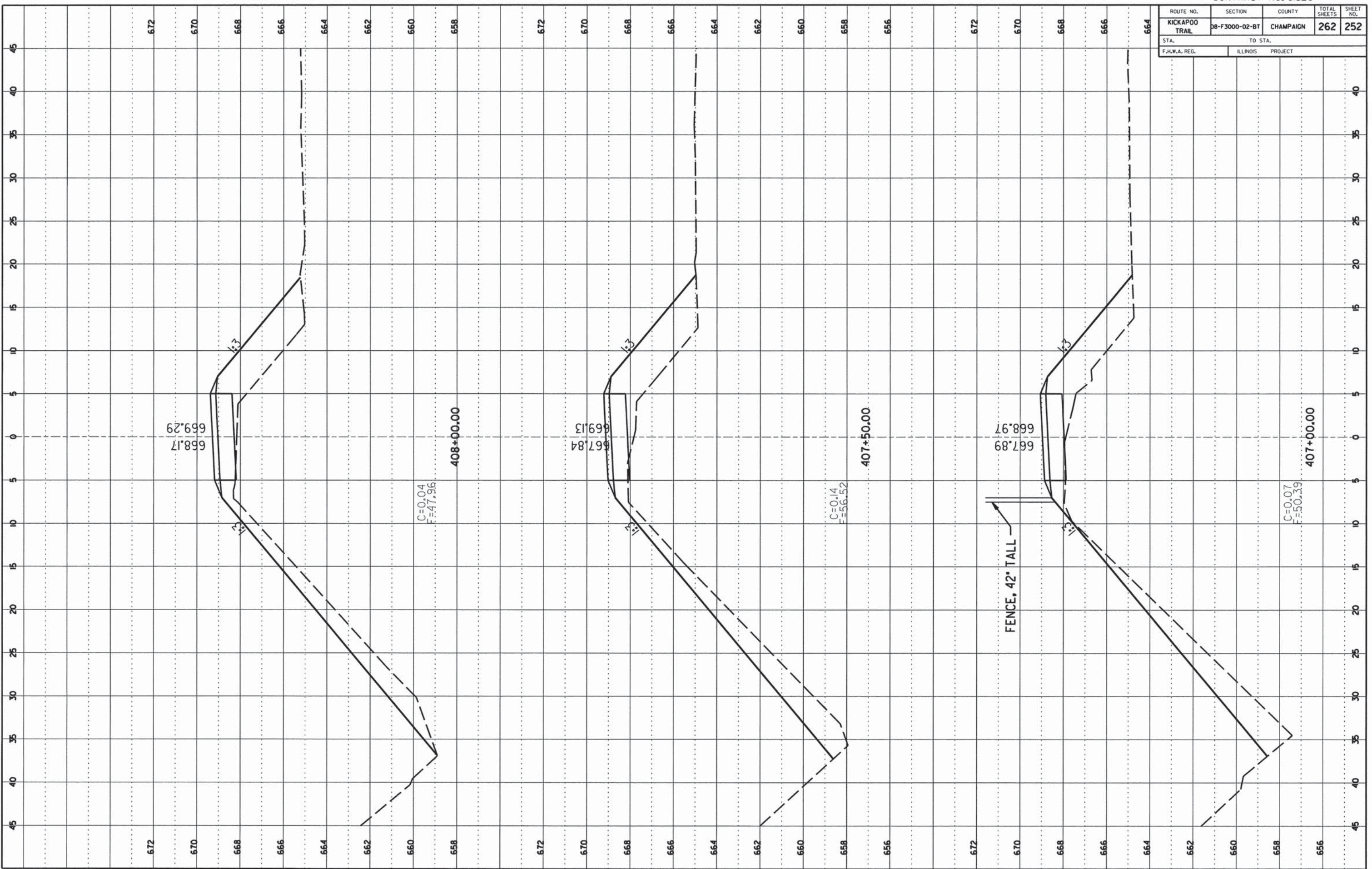

CCFPD KICKAPOO BIKE TRAIL CHAMPAIGN COUNTY

CONTRACT NO. 91520

ROUTE NO.	SECTION	COUNTY	TOTAL SHEETS	SHEET NO.
KICKAPOO TRAIL	08-F3000-02-BT	CHAMPAIGN	262	253
STA. TO STA.		ILLINOIS PROJECT		
F.H.W.A. REG.				

FINAL SURVEY

DATE	BY	APPROVED	DATE

NOTE BOOK NO. \_\_\_\_\_

ORIGINAL SURVEY

DATE	BY	APPROVED	DATE

NOTE BOOK NO. \_\_\_\_\_

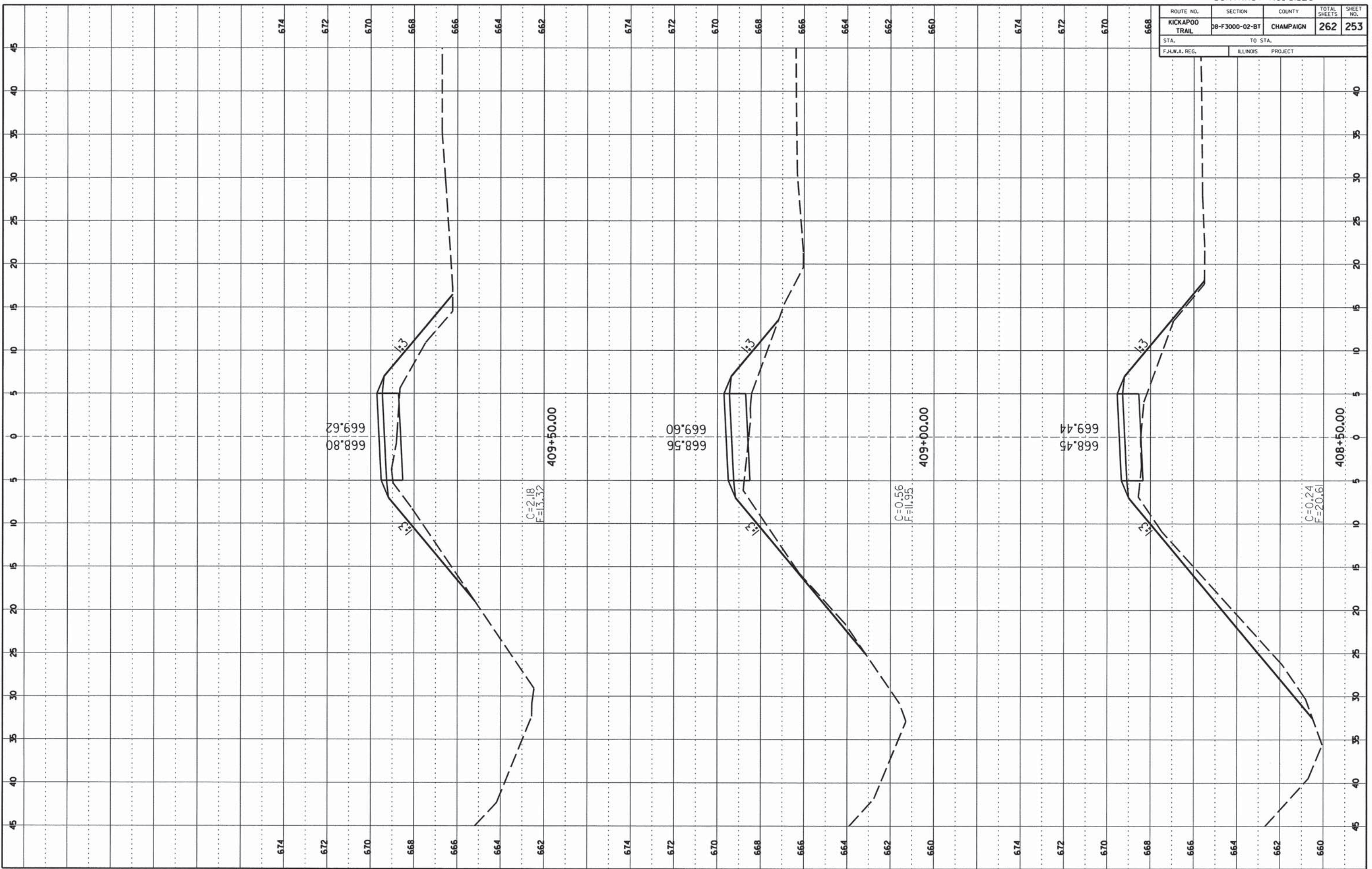

CCFPD KICKAPOO BIKE TRAIL CHAMPAIGN COUNTY



CONTRACT NO. 91520

ROUTE NO.	SECTION	COUNTY	TOTAL SHEETS	SHEET NO.
KICKAPOO TRAIL	DB-F3000-02-BT	CHAMPAIGN	262	254
STA.	TO STA.			
F.H.W.A. REG.	ILLINOIS	PROJECT		

FINAL SURVEY

DATE: \_\_\_\_\_ BY: \_\_\_\_\_

NO. \_\_\_\_\_

REVISIONS:

NO.	DATE	DESCRIPTION

ORIGINAL SURVEY

DATE: \_\_\_\_\_ BY: \_\_\_\_\_

NO. \_\_\_\_\_

REVISIONS:

NO.	DATE	DESCRIPTION

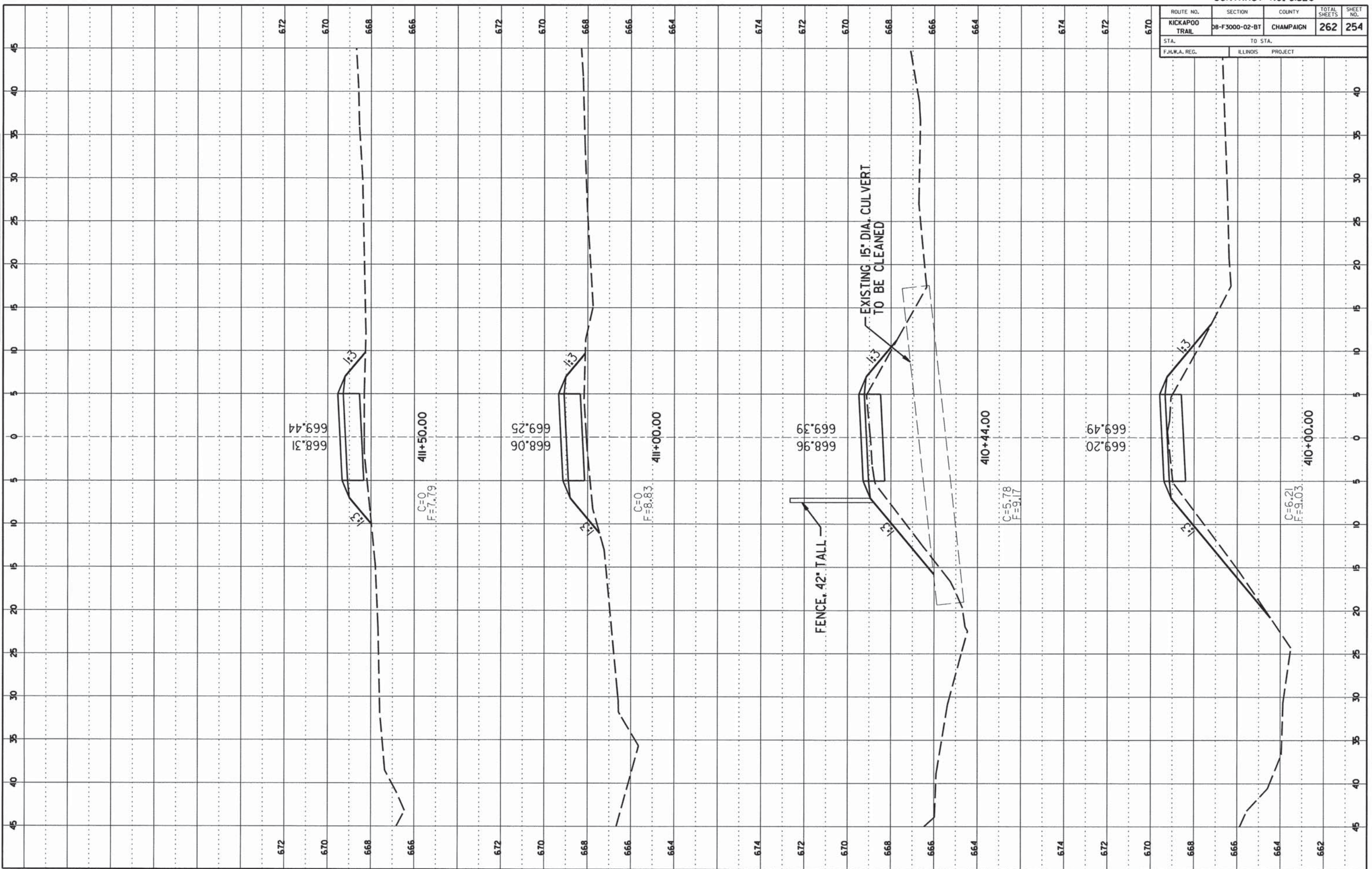

CONTRACT NO. 91520

ROUTE NO.	SECTION	COUNTY	TOTAL SHEETS	SHEET NO.
KICKAPOO TRAIL	DB-F3000-02-BT	CHAMPAIGN	262	255
STA.	TO STA.			
F.H.W.A. REG.	ILLINOIS	PROJECT		

FINAL SURVEY

SPRINTED \_\_\_\_\_ DATE \_\_\_\_\_

PLOTTED \_\_\_\_\_

NOTE BOOK NO. \_\_\_\_\_

IMPLANT \_\_\_\_\_

AREA COVERED \_\_\_\_\_

ORIGINAL SURVEY

SPRINTED \_\_\_\_\_ DATE \_\_\_\_\_

PLOTTED \_\_\_\_\_

NOTE BOOK NO. \_\_\_\_\_

IMPLANT \_\_\_\_\_

AREA COVERED \_\_\_\_\_

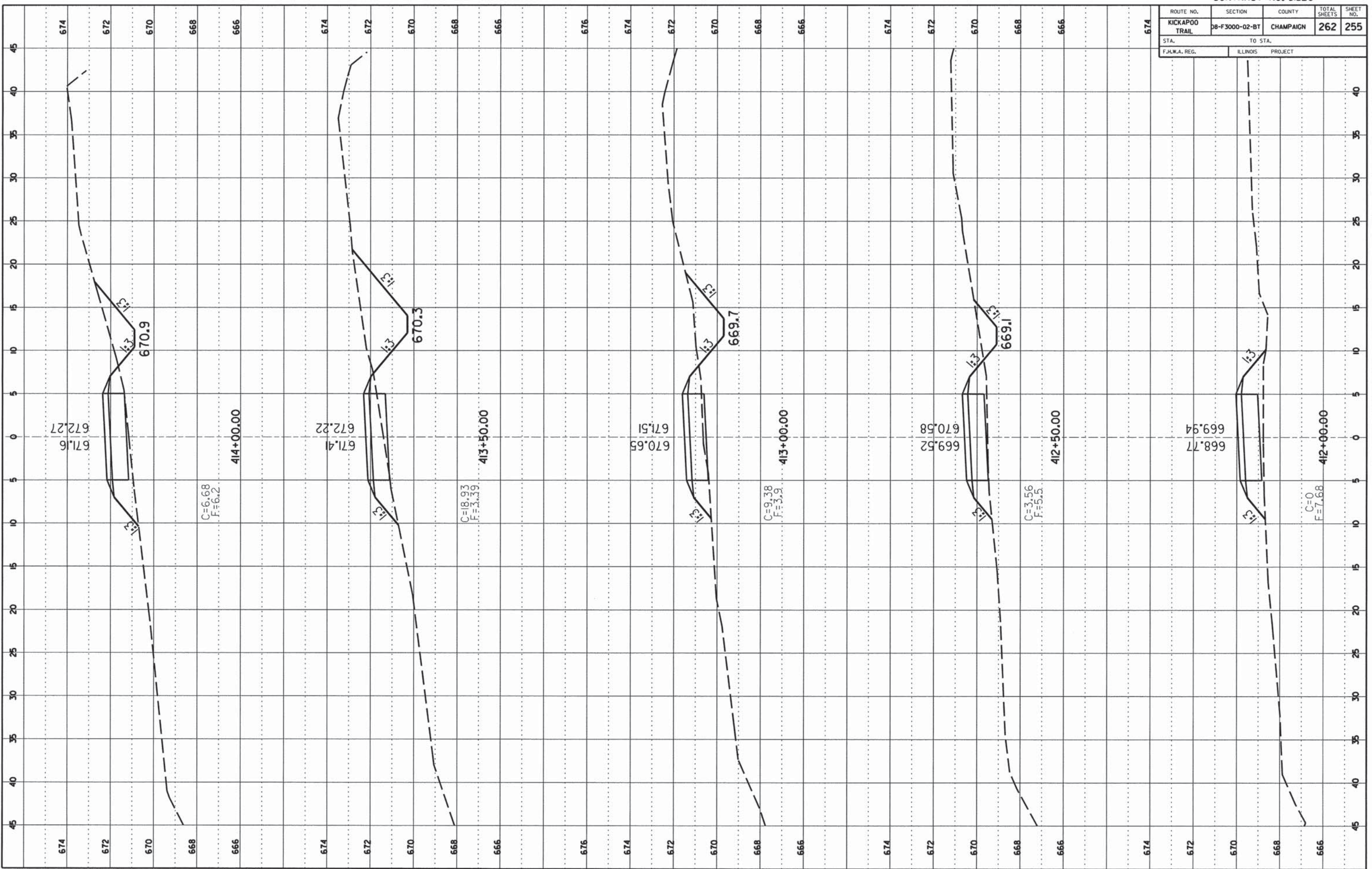

CCFPD KICKAPOO BIKE TRAIL CHAMPAIGN COUNTY

CONTRACT NO. 91520

ROUTE NO.	SECTION	COUNTY	TOTAL SHEETS	SHEET NO.
KICKAPOO TRAIL	08-F3000-02-BT	CHAMPAIGN	262	256
STA.	TO STA.			
F.H.W.A. REG.	ILLINOIS PROJECT			

DATE	
BY	
REVISION	
NO.	
DATE	
BY	
REVISION	
NO.	

DATE	
BY	
REVISION	
NO.	
DATE	
BY	
REVISION	
NO.	

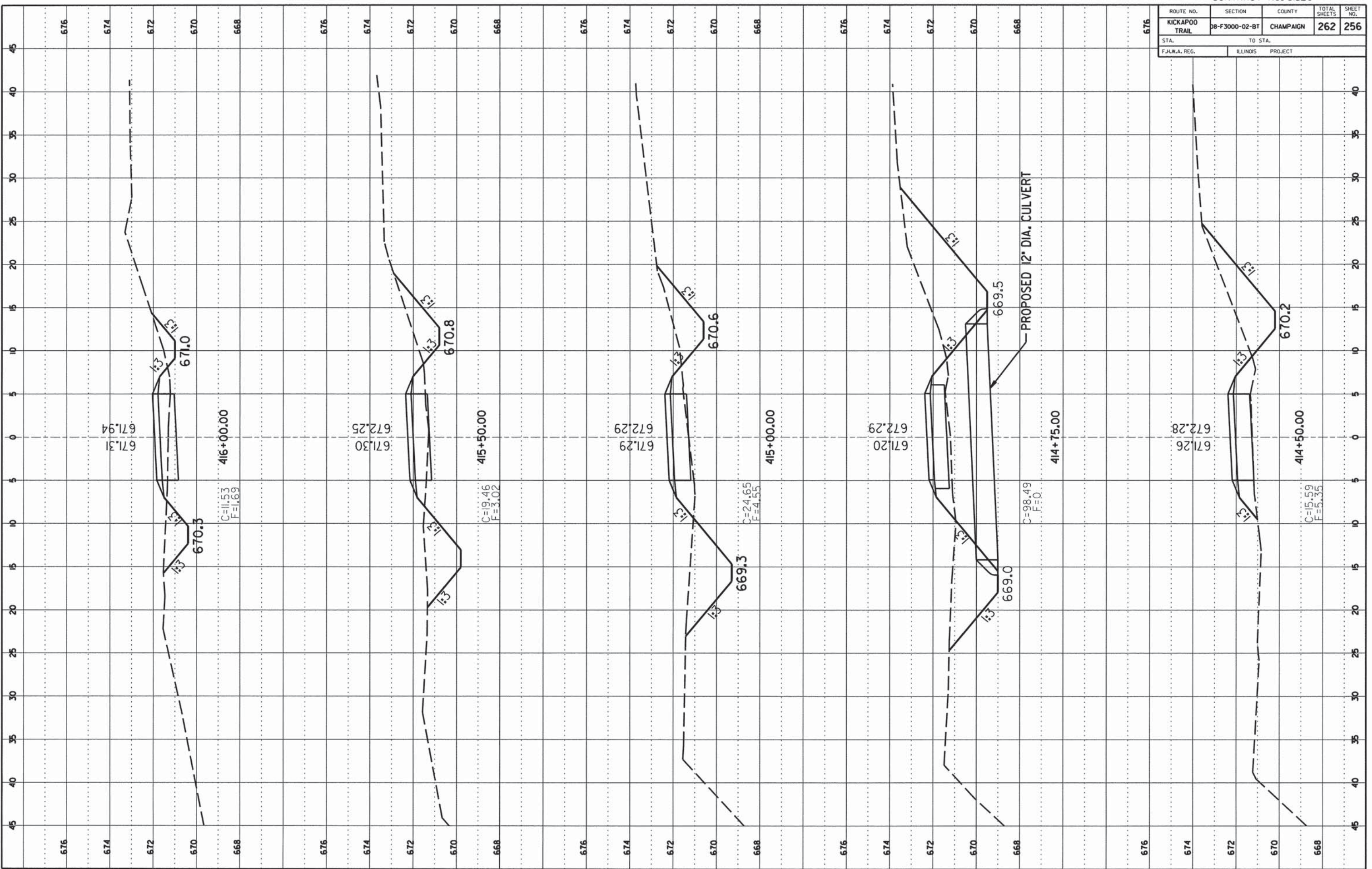

CCFPD KICKAPOO BIKE TRAIL CHAMPAIGN COUNTY

CONTRACT NO. 91520

ROUTE NO.	SECTION	COUNTY	TOTAL SHEETS	SHEET NO.
KICKAPOO TRAIL	08-F3000-02-BT	CHAMPAIGN	262	257
STA.		TO STA.		
F.H.W.A. REG.		ILLINOIS PROJECT		

FINAL SURVEY

DATE	
BY	
REVISION	
NO.	
DATE	
BY	
REVISION	
NO.	

ORIGINAL SURVEY

DATE	
BY	
REVISION	
NO.	
DATE	
BY	
REVISION	
NO.	

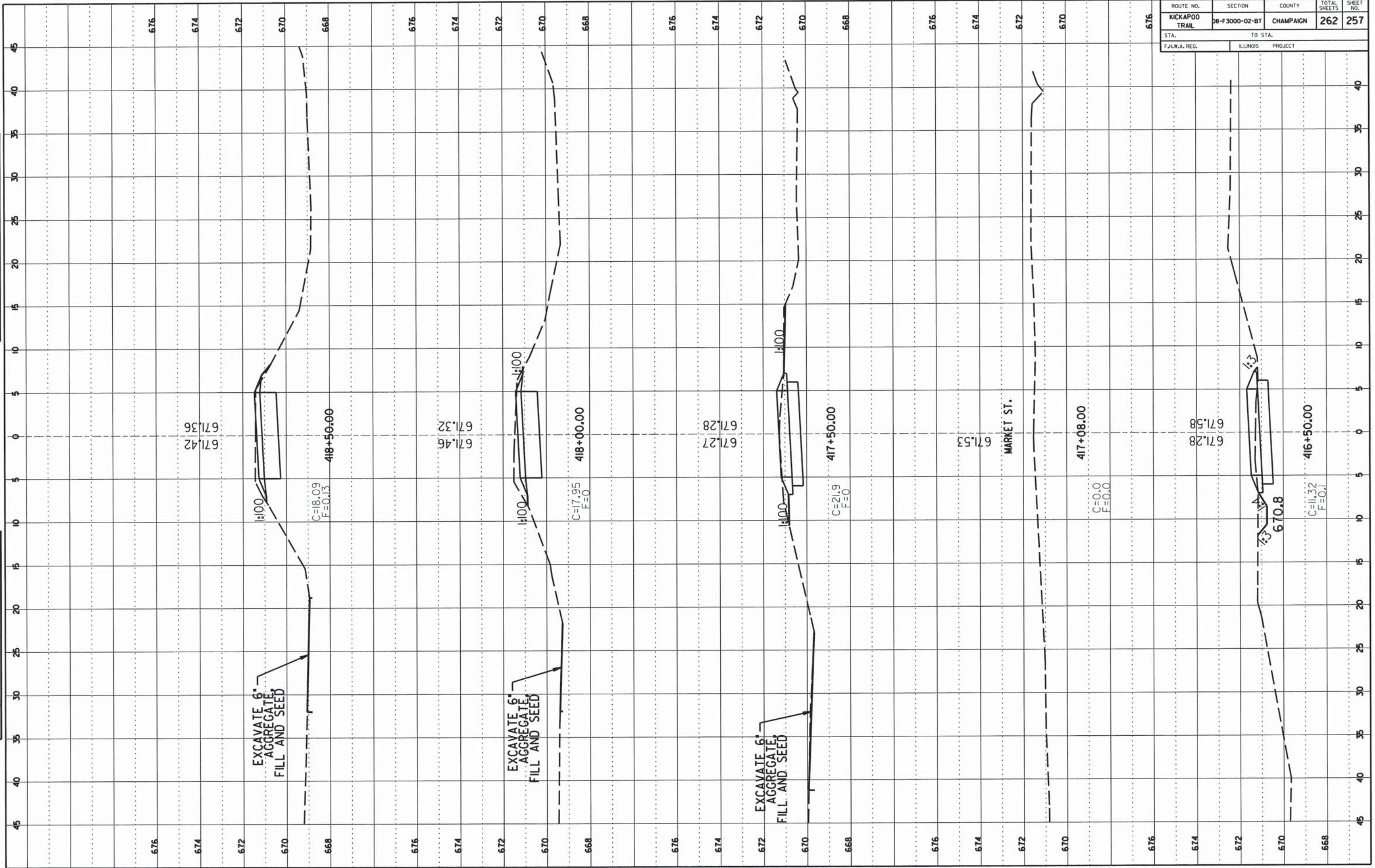

CCFPD KICKAPOO BIKE TRAIL

CHAMPAIGN COUNTY

CONTRACT NO. 91520

ROUTE NO.	SECTION	COUNTY	TOTAL SHEETS	SHEET NO.
KICKAPOO TRAIL	08-F3000-02-BT	CHAMPAIGN	262	258
STA. TO STA.		ILLINOIS PROJECT		
F.H.W.A. REG.				

FINAL SURVEY

NO. \_\_\_\_\_

DATE \_\_\_\_\_

BY \_\_\_\_\_

PROJECT \_\_\_\_\_

PLANNED \_\_\_\_\_

TEMP. USE \_\_\_\_\_

AREA COVERED \_\_\_\_\_

ORIGINAL SURVEY

NO. \_\_\_\_\_

DATE \_\_\_\_\_

BY \_\_\_\_\_

PROJECT \_\_\_\_\_

PLANNED \_\_\_\_\_

TEMP. USE \_\_\_\_\_

AREA COVERED \_\_\_\_\_

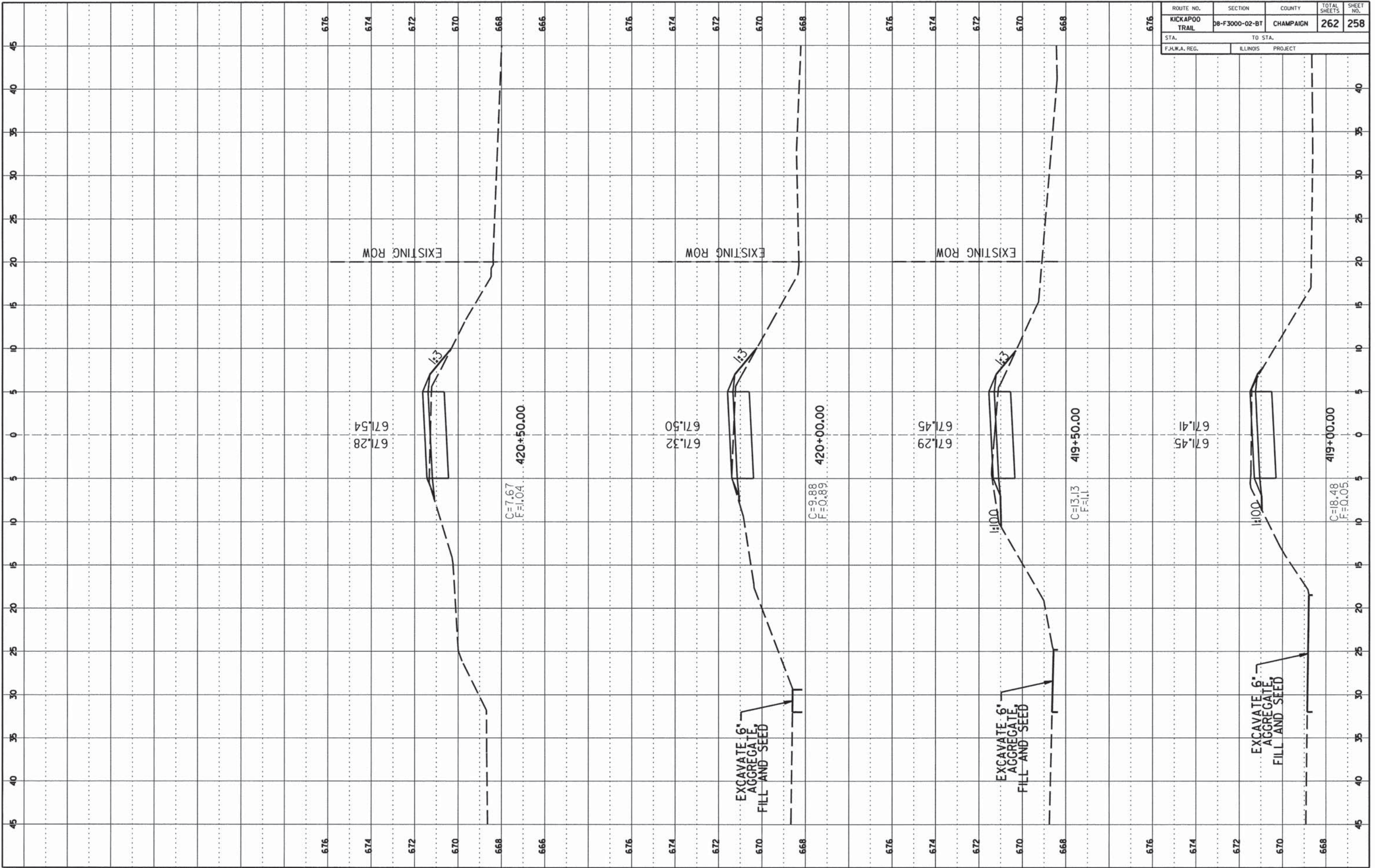

CONTRACT NO. 91520

ROUTE NO.	SECTION	COUNTY	TOTAL SHEETS	SHEET NO.
KICKAPOO TRAIL	08-F3000-02-BT	CHAMPAIGN	262	259
STA.		TO STA.		
F.H.W.A. REG.		ILLINOIS PROJECT		

FINAL SURVEY

DATE: \_\_\_\_\_ BY: \_\_\_\_\_

NO. \_\_\_\_\_

APPROVED: \_\_\_\_\_

DATE: \_\_\_\_\_ BY: \_\_\_\_\_

NO. \_\_\_\_\_

APPROVED: \_\_\_\_\_

ORIGINAL SURVEY

DATE: \_\_\_\_\_ BY: \_\_\_\_\_

NO. \_\_\_\_\_

APPROVED: \_\_\_\_\_

DATE: \_\_\_\_\_ BY: \_\_\_\_\_

NO. \_\_\_\_\_

APPROVED: \_\_\_\_\_

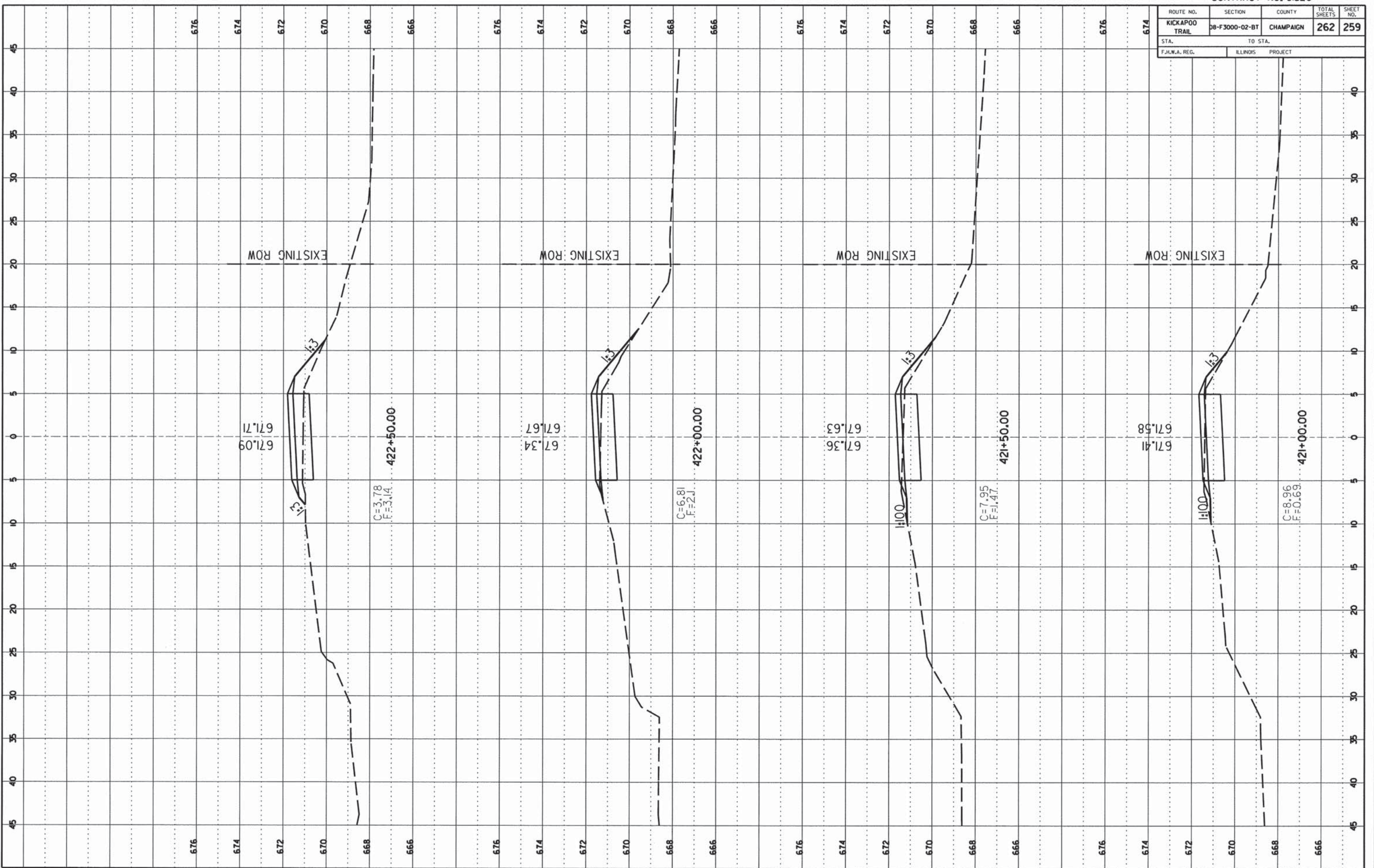

CCFPD KICKAPOO BIKE TRAIL CHAMPAIGN COUNTY

CONTRACT NO. 91520

ROUTE NO.	SECTION	COUNTY	TOTAL SHEETS	SHEET NO.
KICKAPOO TRAIL	08-F3000-02-BT	CHAMPAIGN	262	260
STA. TO STA.		ILLINOIS PROJECT		
F.H.W.A. REG.				

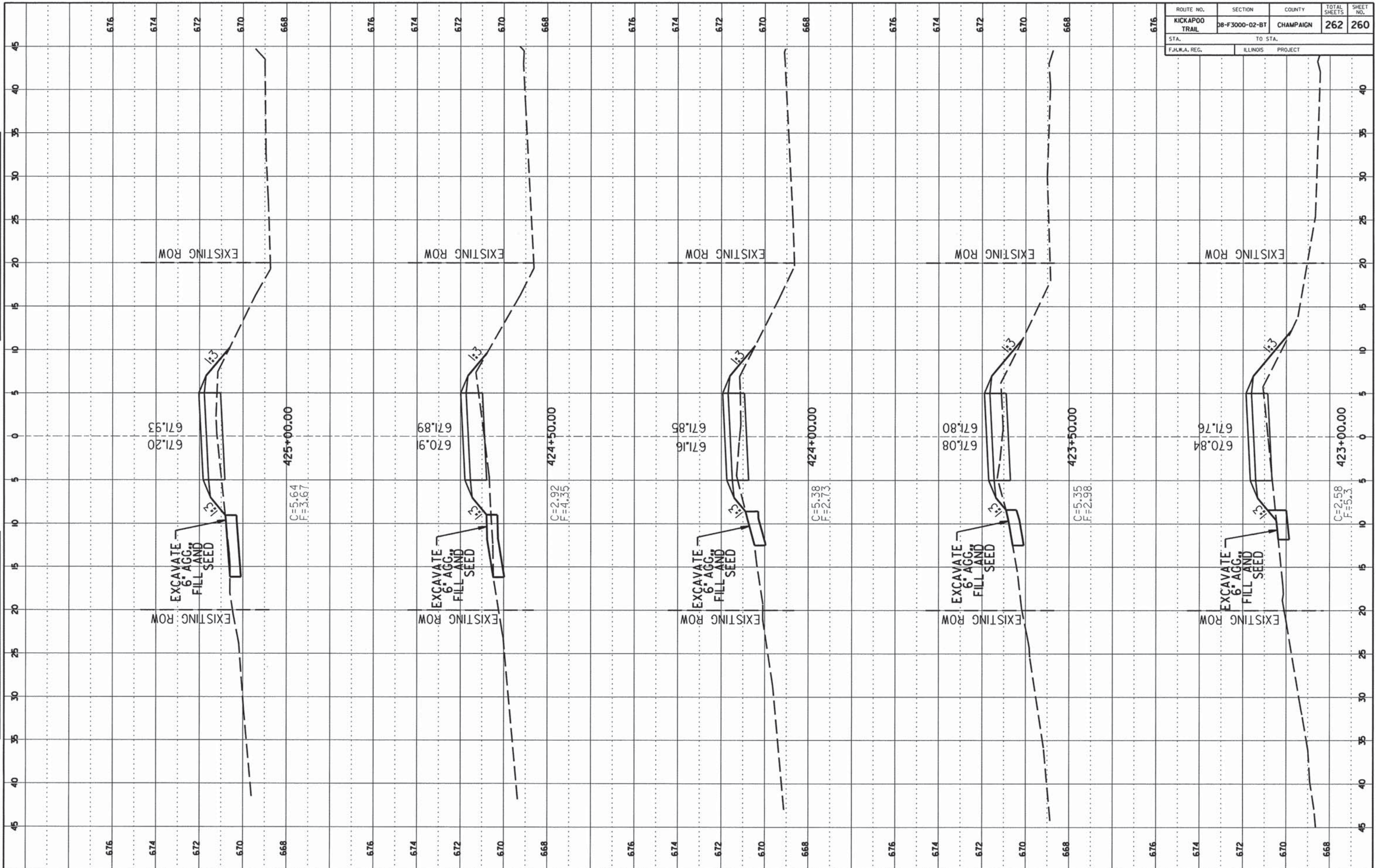

FINAL SURVEY		DATE
DATE	BY	
NO.	NO.	
NO.	NO.	

ORIGINAL SURVEY		DATE
DATE	BY	
NO.	NO.	
NO.	NO.	

CONTRACT NO. 91520

ROUTE NO.	SECTION	COUNTY	TOTAL SHEETS	SHEET NO.
KICKAPOO TRAIL	08-F3000-02-BT	CHAMPAIGN	262	261
STA.		TO STA.		
F.I.L.W.A. REG.		ILLINOIS PROJECT		

FINAL SURVEY  
 DATE: \_\_\_\_\_  
 BY: \_\_\_\_\_  
 CHECKED: \_\_\_\_\_  
 NO. \_\_\_\_\_

ORIGINAL SURVEY  
 DATE: \_\_\_\_\_  
 BY: \_\_\_\_\_  
 CHECKED: \_\_\_\_\_  
 NO. \_\_\_\_\_

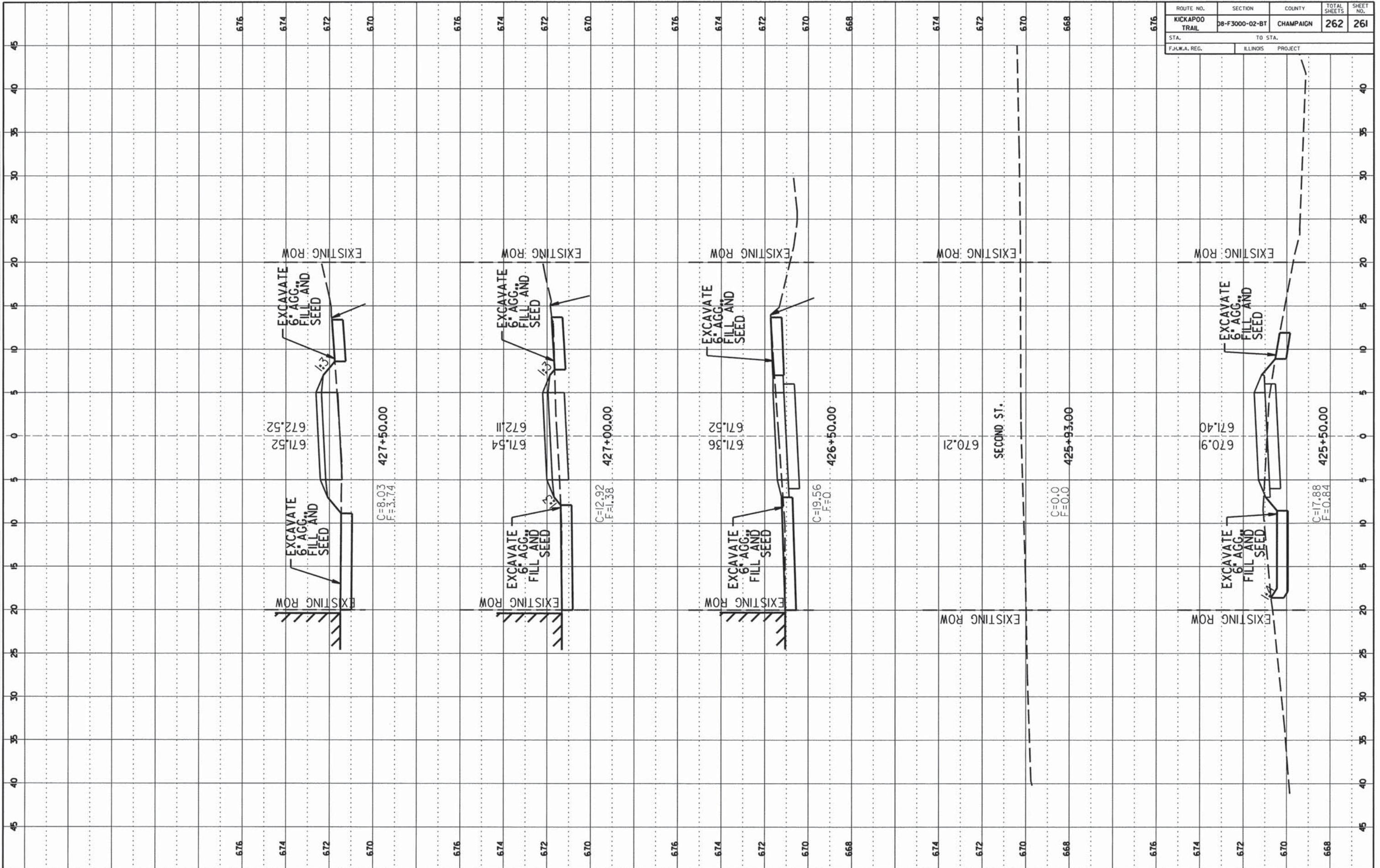





Attachment G:

**Kickapoo Rail Trail Phase 1**

**Construction Cross Section Drawings**

**Sheets indicating culvert crossings and slopes**

CONTRACT NO. 91520

ROUTE NO.	SECTION	COUNTY	TOTAL SHEETS	SHEET NO.
KICKAPOO TRAIL	DB-F3000-02-BT	CHAMPAIGN	262	165
STA.	TO STA.			
F.H.W.A. REG.	ILLINOIS	PROJECT		

FINAL SURVEY  
 NO. \_\_\_\_\_  
 DATE \_\_\_\_\_

ORIGINAL SURVEY  
 NO. \_\_\_\_\_  
 DATE \_\_\_\_\_

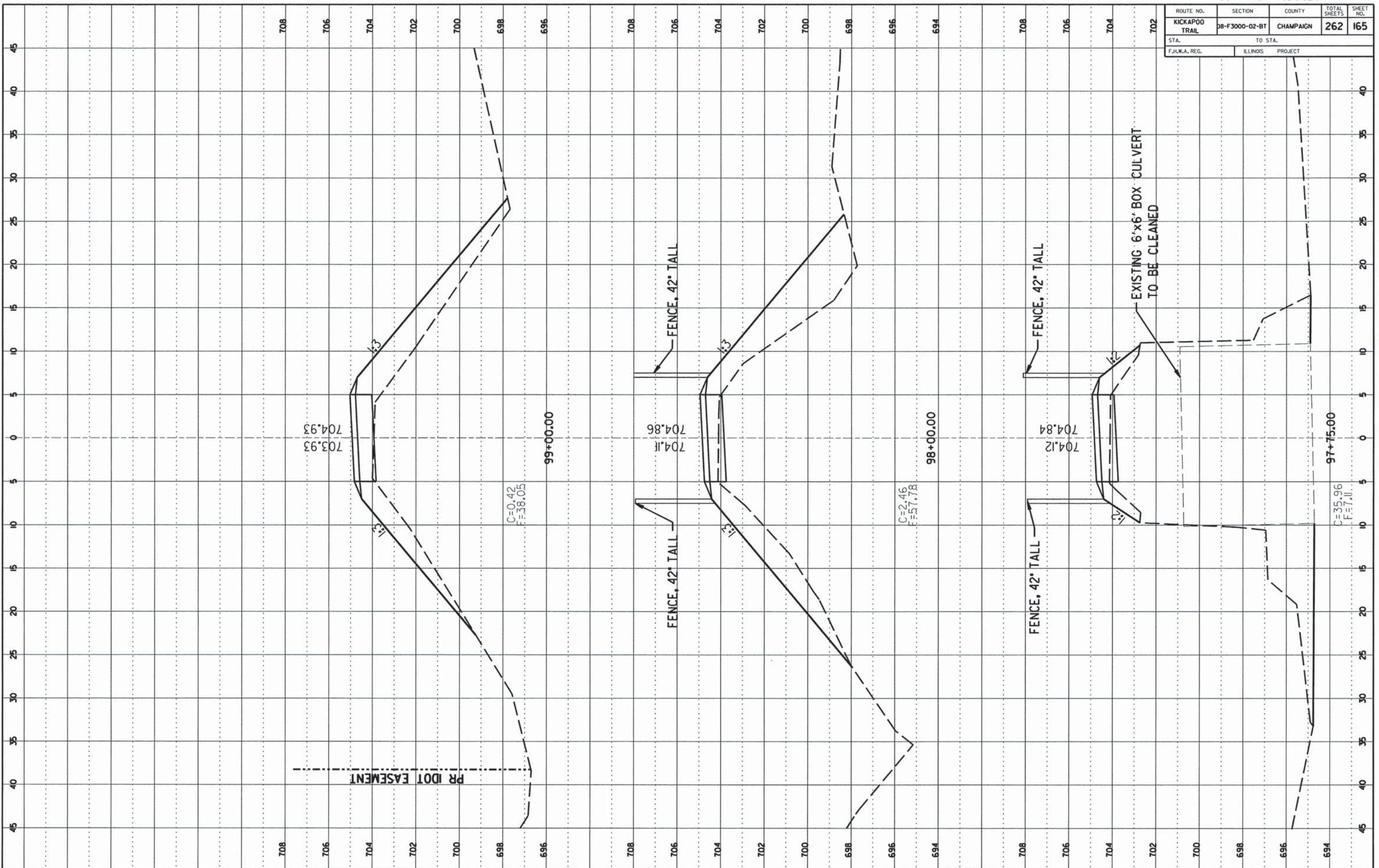

CCFPD KICKAPOO BIKE TRAIL CHAMPAIGN COUNTY

CONTRACT NO. 91520

ROUTE NO.	SECTION	COUNTY	TOTAL SHEETS	SHEET NO.
KICKAPOO TRAIL	D8-F3000-02-BT	CHAMPAIGN	262	183
STA. F.H.W.A. REG.		TO STA. ILLINOIS PROJECT		

FINAL SURVEY

DATE: \_\_\_\_\_

BY: \_\_\_\_\_

NO. \_\_\_\_\_

DATE: \_\_\_\_\_

BY: \_\_\_\_\_

NO. \_\_\_\_\_

ORIGINAL SURVEY

DATE: \_\_\_\_\_

BY: \_\_\_\_\_

NO. \_\_\_\_\_

DATE: \_\_\_\_\_

BY: \_\_\_\_\_

NO. \_\_\_\_\_

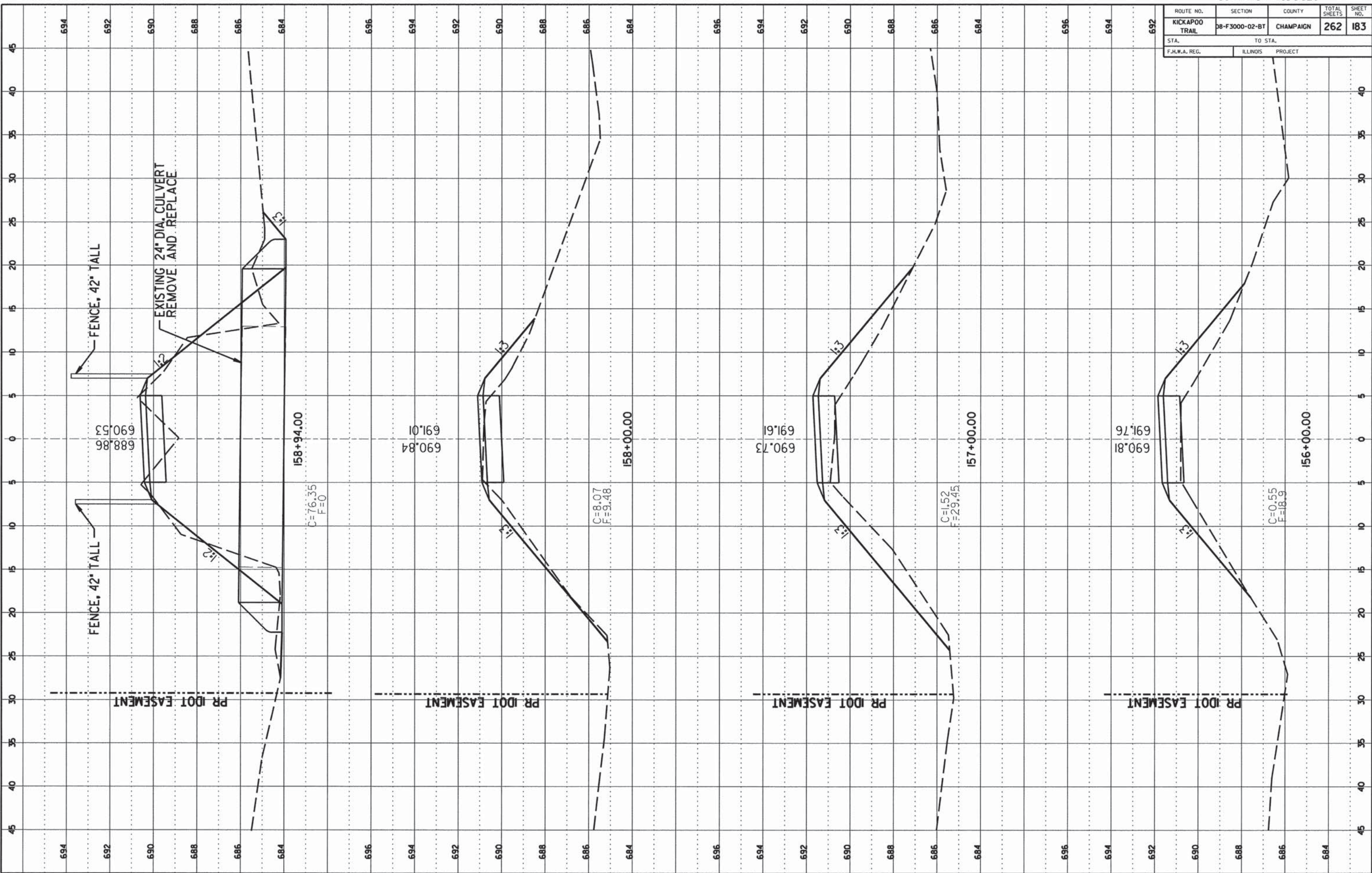

CCFPD KICKAPOO BIKE TRAIL CHAMPAIGN COUNTY

CONTRACT NO. 91520

ROUTE NO.	SECTION	COUNTY	TOTAL SHEETS	SHEET NO.
KICKAPOO TRAIL	08-F3000-02-BT	CHAMPAIGN	262	185
STA.	TO STA.			
F.H.W.A. REG.	ILLINOIS	PROJECT		

FINAL SURVEY  
 NO. \_\_\_\_\_  
 DATE \_\_\_\_\_  
 BY \_\_\_\_\_  
 CHECKED \_\_\_\_\_  
 DATE \_\_\_\_\_

ORIGINAL SURVEY  
 NO. \_\_\_\_\_  
 DATE \_\_\_\_\_  
 BY \_\_\_\_\_  
 CHECKED \_\_\_\_\_  
 DATE \_\_\_\_\_

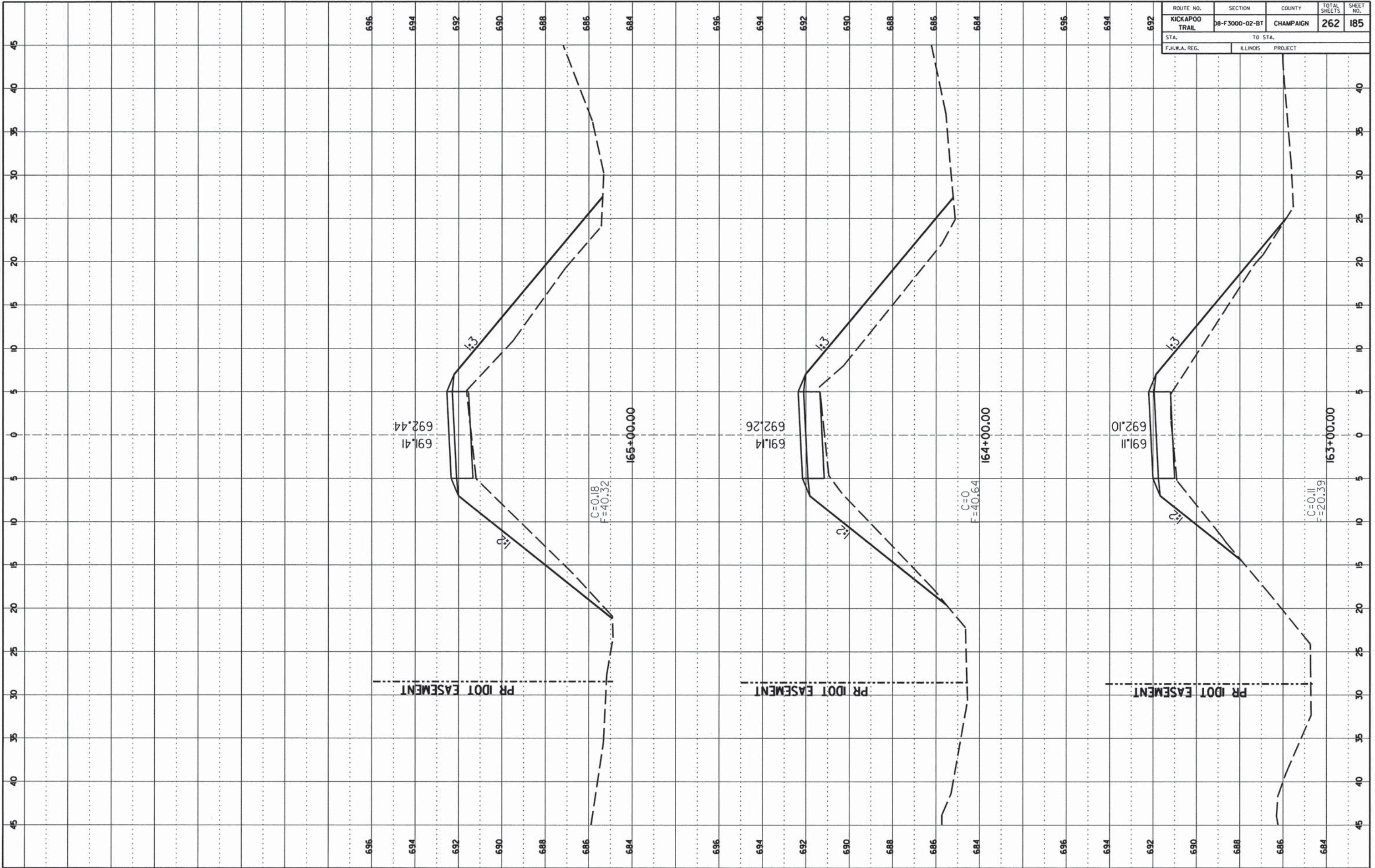

CONTRACT NO. 91520

ROUTE NO.	SECTION	COUNTY	TOTAL SHEETS	SHEET NO.
KICKAPOO TRAIL	08-F3000-02-BT	CHAMPAIGN	262	190
STA. TO STA.		ILLINOIS PROJECT		
F.H.W.A. REG.				

FINAL SURVEY

DATE: \_\_\_\_\_ BY: \_\_\_\_\_

NO. \_\_\_\_\_

APPROVED: \_\_\_\_\_

DATE: \_\_\_\_\_ BY: \_\_\_\_\_

NO. \_\_\_\_\_

APPROVED: \_\_\_\_\_

ORIGINAL SURVEY

DATE: \_\_\_\_\_ BY: \_\_\_\_\_

NO. \_\_\_\_\_

APPROVED: \_\_\_\_\_

DATE: \_\_\_\_\_ BY: \_\_\_\_\_

NO. \_\_\_\_\_

APPROVED: \_\_\_\_\_

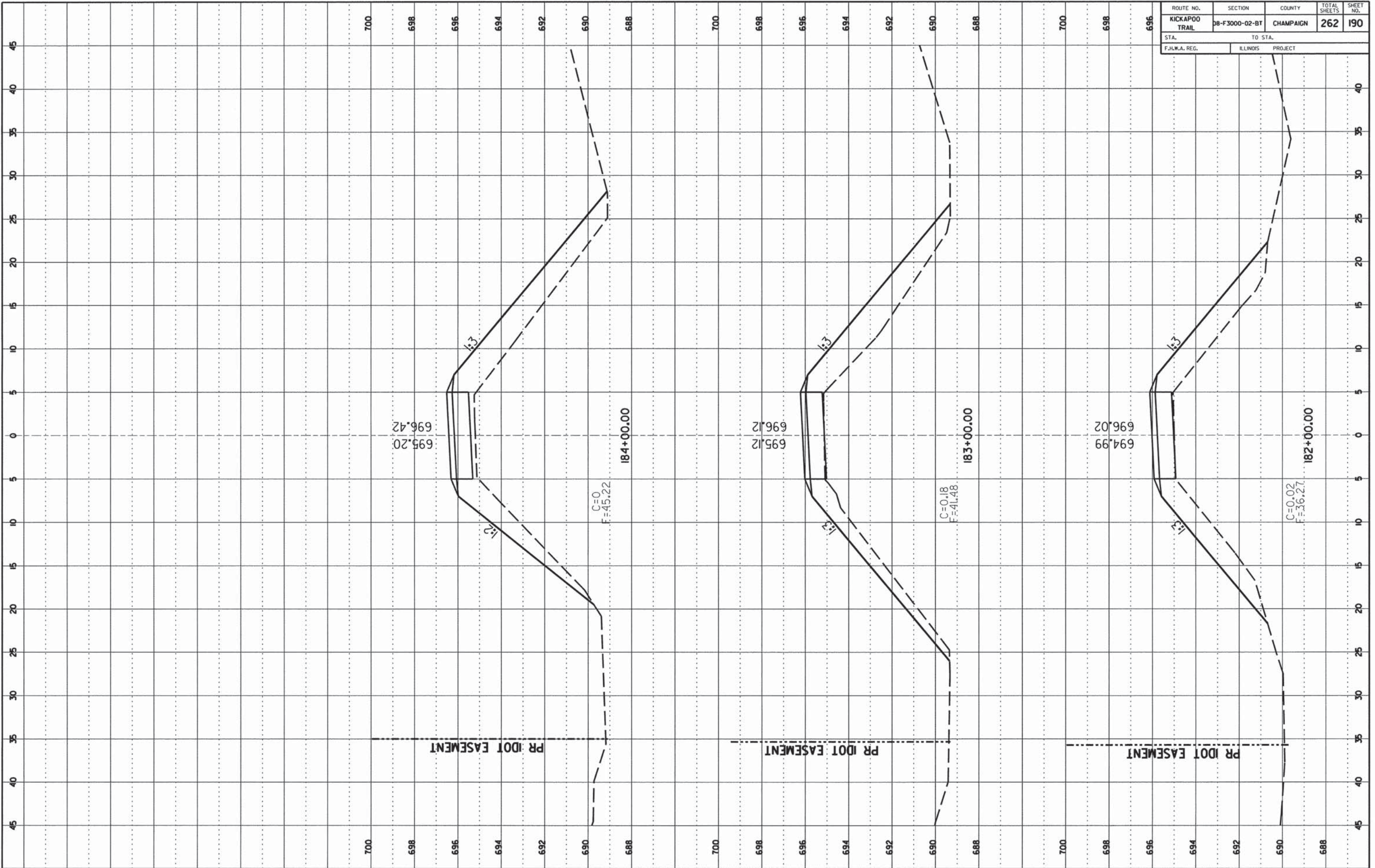

CONTRACT NO. 9I520

ROUTE NO.	SECTION	COUNTY	TOTAL SHEETS	SHEET NO.
KICKAPOO TRAIL	08-F3000-02-BT	CHAMPAIGN	262	191
STA.		TO STA.		
F.H.W.A. REG.		ILLINOIS PROJECT		

NO.	DATE	BY

FINAL SURVEY  
 NO. \_\_\_\_\_ DATE \_\_\_\_\_  
 BY \_\_\_\_\_  
 CHECKED \_\_\_\_\_  
 DATE \_\_\_\_\_

NO.	DATE	BY

ORIGINAL SURVEY  
 NO. \_\_\_\_\_ DATE \_\_\_\_\_  
 BY \_\_\_\_\_  
 CHECKED \_\_\_\_\_  
 DATE \_\_\_\_\_

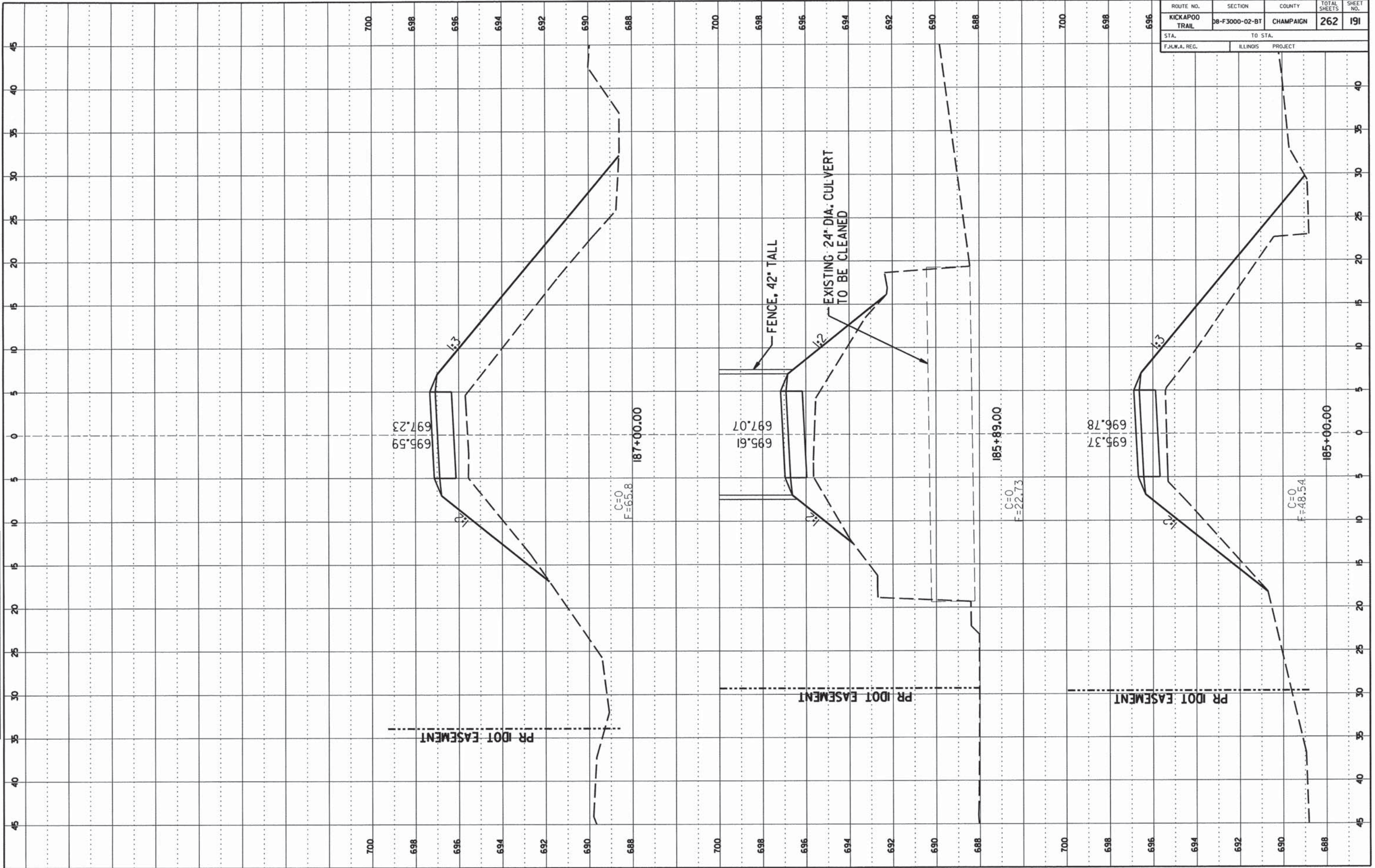

CONTRACT NO. 91520

ROUTE NO.	SECTION	COUNTY	TOTAL SHEETS	SHEET NO.
KICKAPOO TRAIL	08-F3000-02-BT	CHAMPAIGN	262	193
STA.		TO STA.		
F.H.W.A. REG.		ILLINOIS PROJECT		

FINAL SURVEY

DATE: \_\_\_\_\_

BY: \_\_\_\_\_

PROJECT: \_\_\_\_\_

PLATTED: \_\_\_\_\_

REVISION: \_\_\_\_\_

NOTE BOOK NO.: \_\_\_\_\_

AREA ORDERED: \_\_\_\_\_

ORIGINAL SURVEY

DATE: \_\_\_\_\_

BY: \_\_\_\_\_

PROJECT: \_\_\_\_\_

PLATTED: \_\_\_\_\_

REVISION: \_\_\_\_\_

NOTE BOOK NO.: \_\_\_\_\_

AREA ORDERED: \_\_\_\_\_

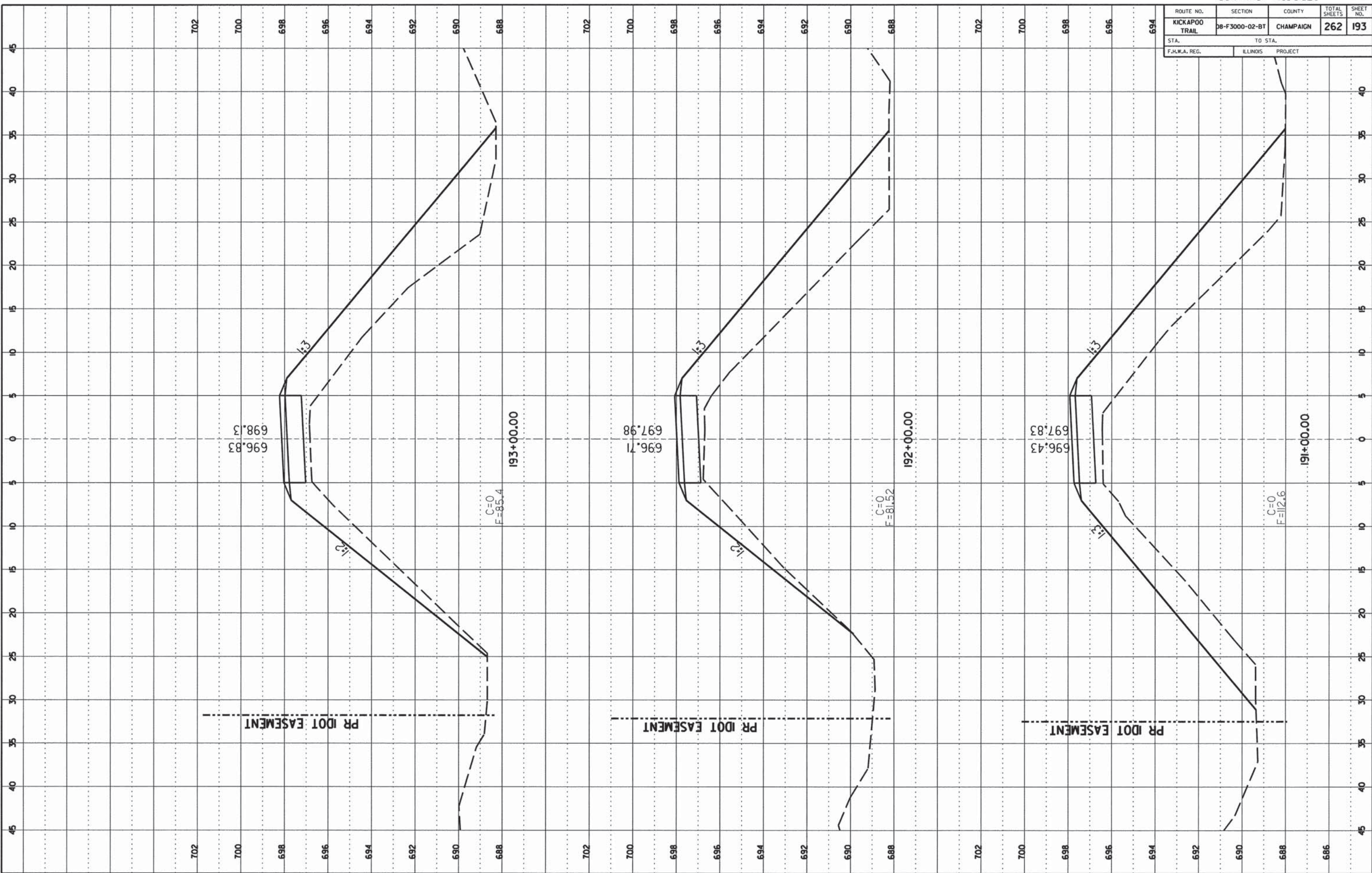



CONTRACT NO. 91520

ROUTE NO.	SECTION	COUNTY	TOTAL SHEETS	SHEET NO.
KICKAPOO TRAIL	DB-F3000-02-BT	CHAMPAIGN	262	194
STA.		TO STA.		
F.H.W.A. REG.		ILLINOIS PROJECT		

FINAL SURVEY  
 NO. \_\_\_\_\_  
 DATE \_\_\_\_\_

ORIGINAL SURVEY  
 NO. \_\_\_\_\_  
 DATE \_\_\_\_\_

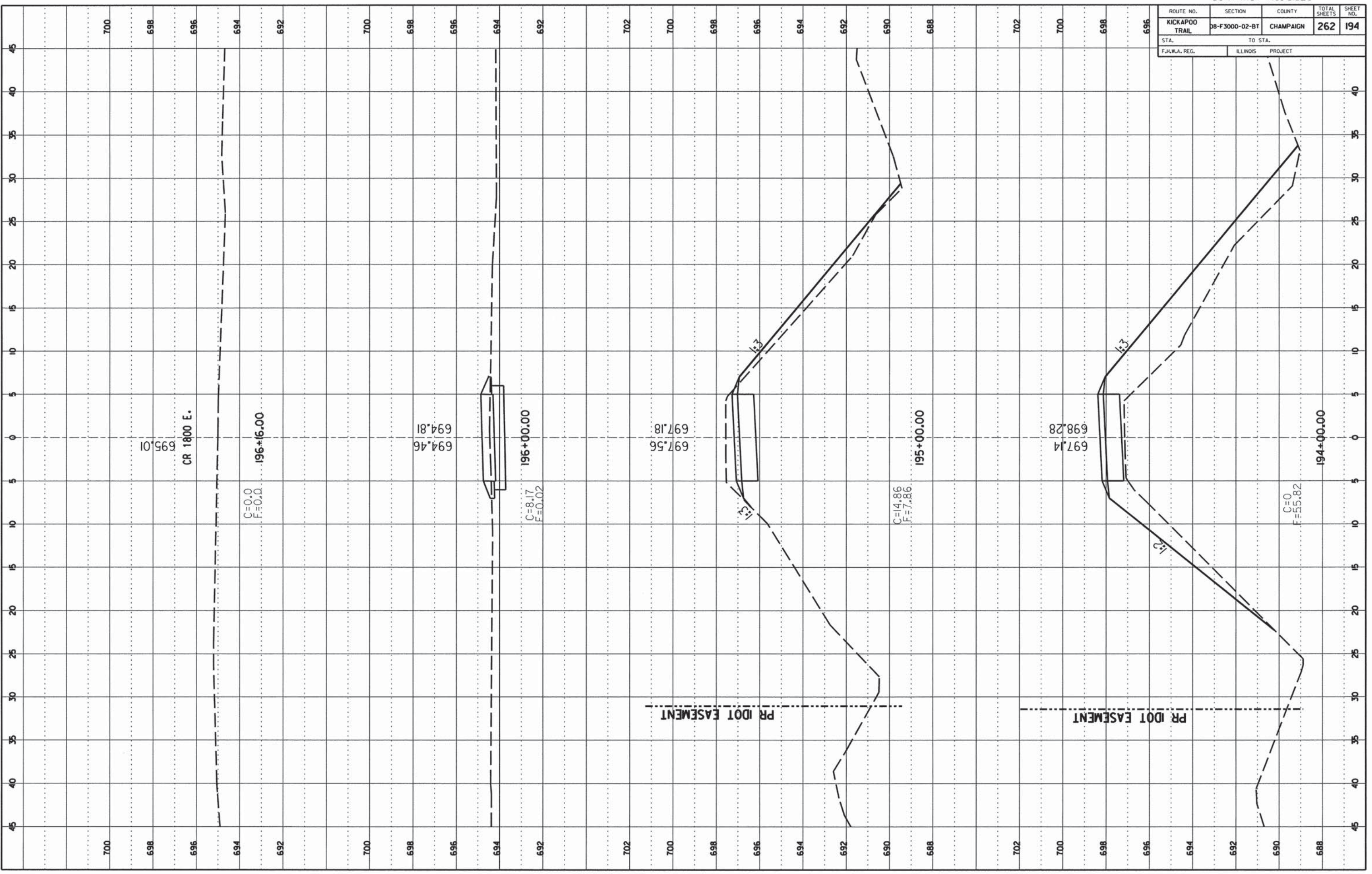

CONTRACT NO. 91520

ROUTE NO.	SECTION	COUNTY	TOTAL SHEETS	SHEET NO.
KICKAPOO TRAIL	08-F3000-02-BT	CHAMPAIGN	262	197
STA.		TO STA.		
F.H.W.A. REG.		ILLINOIS PROJECT		

FINAL SURVEY  
 NO. \_\_\_\_\_  
 DATE \_\_\_\_\_

ORIGINAL SURVEY  
 NO. \_\_\_\_\_  
 DATE \_\_\_\_\_

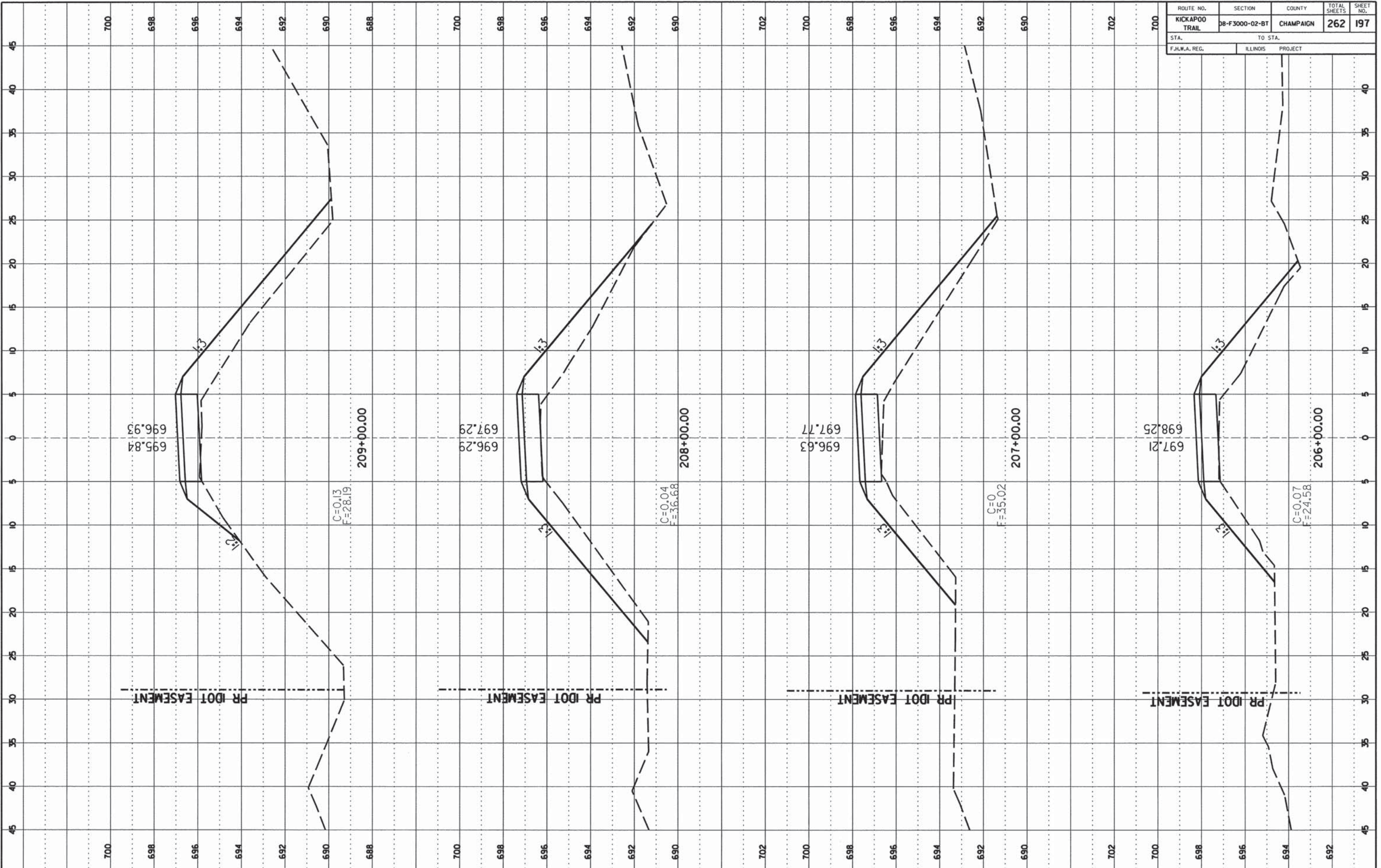

CONTRACT NO. 91520

ROUTE NO.	SECTION	COUNTY	TOTAL SHEETS	SHEET NO.
KICKAPOO TRAIL	08-F3000-02-BT	CHAMPAIGN	262	207
STA.	TO STA.			
F.H.W.A. REG.	ILLINOIS	PROJECT		

NO.	DATE	BY	DATE

NO.	DATE	BY	DATE

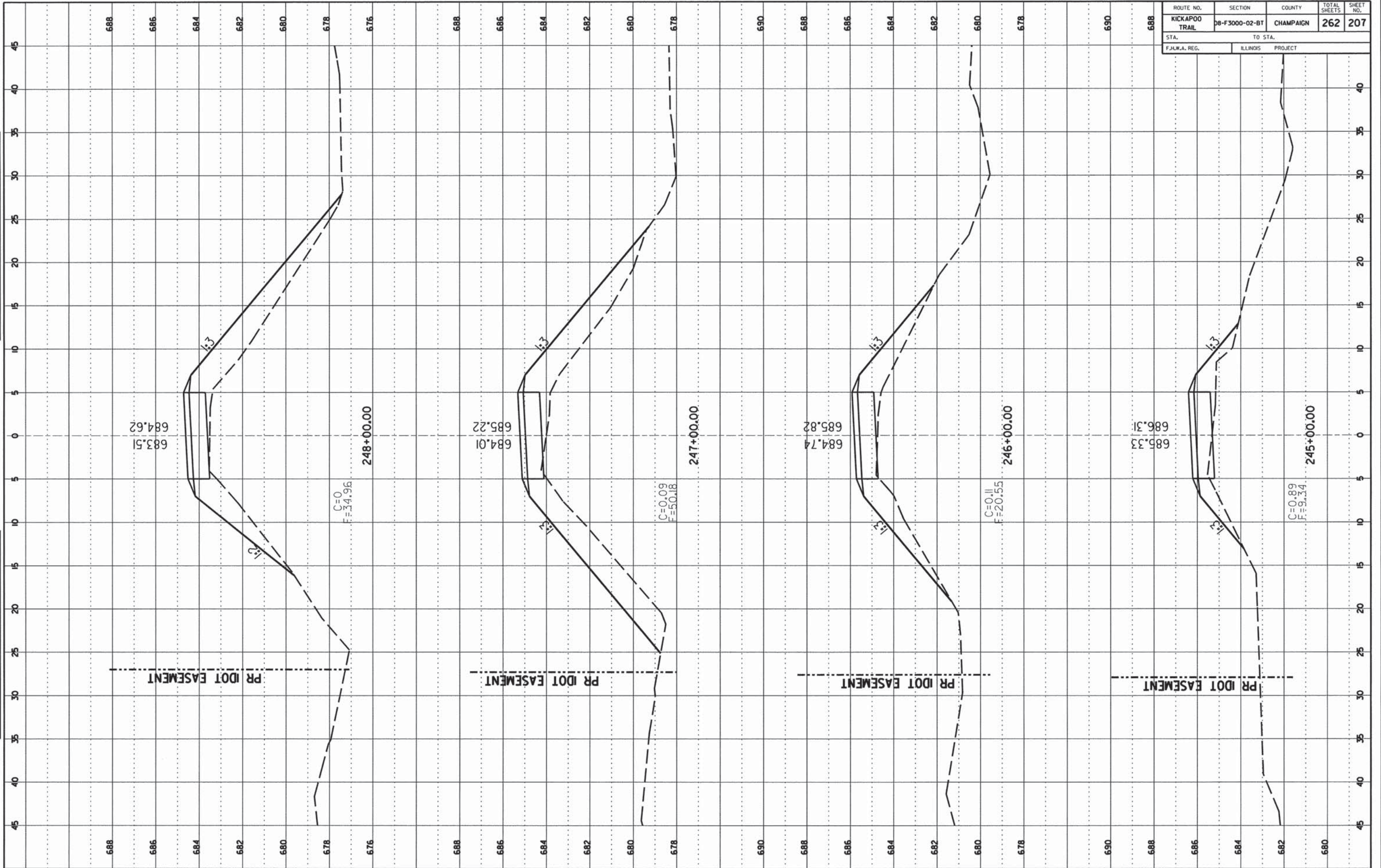

CCFPD KICKAPOO BIKE TRAIL CHAMPAIGN COUNTY

CONTRACT NO. 91520

ROUTE NO.	SECTION	COUNTY	TOTAL SHEETS	SHEET NO.
KICKAPOO TRAIL	08-F3000-02-BT	CHAMPAIGN	262	208
STA.	TO STA.			
F.H.W.A. REG.	ILLINOIS	PROJECT		

FINAL SURVEY

DATE: \_\_\_\_\_ BY: \_\_\_\_\_

NO. \_\_\_\_\_

DATE: \_\_\_\_\_ BY: \_\_\_\_\_

NO. \_\_\_\_\_

ORIGINAL SURVEY

DATE: \_\_\_\_\_ BY: \_\_\_\_\_

NO. \_\_\_\_\_

DATE: \_\_\_\_\_ BY: \_\_\_\_\_

NO. \_\_\_\_\_

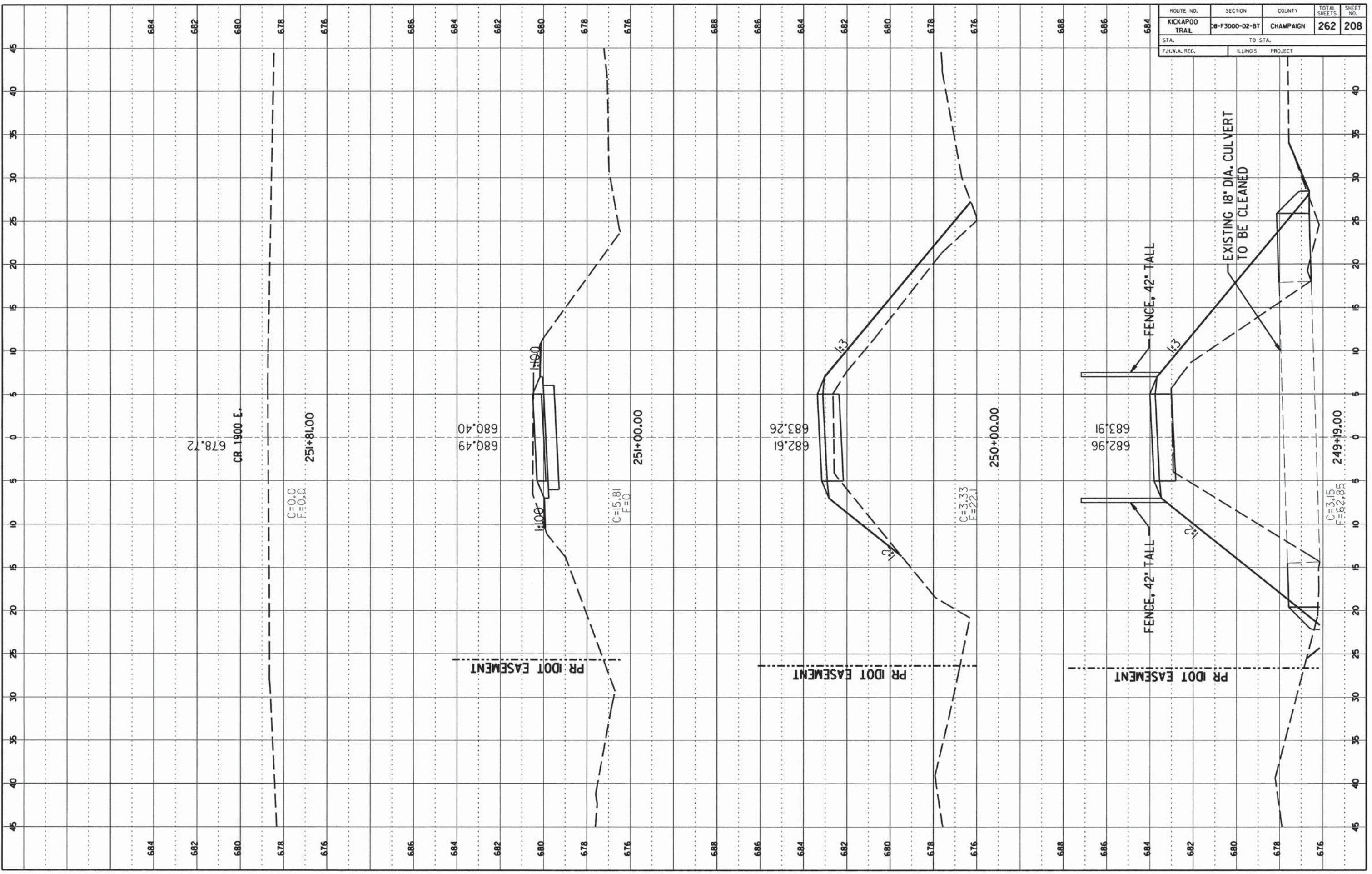

CONTRACT NO. 91520

ROUTE NO.	SECTION	COUNTY	TOTAL SHEETS	SHEET NO.
KICKAPOO TRAIL	08-F3000-02-BT	CHAMPAIGN	262	209
STA. F.H.W.A. REG.		TO STA. ILLINOIS PROJECT		

DATE	BY

FINAL SURVEY  
NOTE BOOK NO. \_\_\_\_\_  
AREAS DECIDED \_\_\_\_\_

DATE	BY

ORIGINAL SURVEY  
NOTE BOOK NO. \_\_\_\_\_  
AREAS DECIDED \_\_\_\_\_

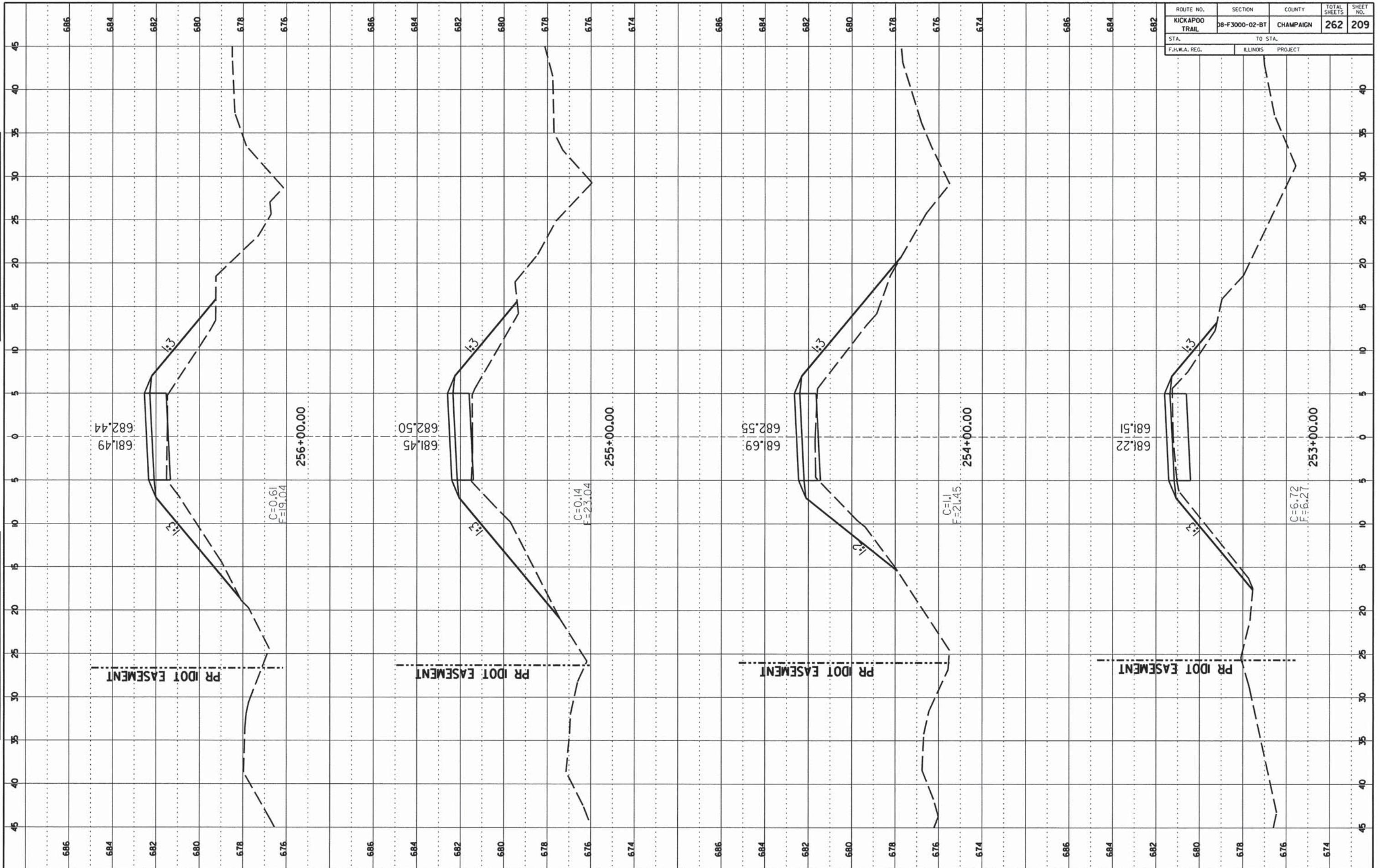

CCFPD KICKAPOO BIKE TRAIL CHAMPAIGN COUNTY

SHEET 209 OF 262 SHEETS 13-620A

CONTRACT NO. 91520

ROUTE NO.	SECTION	COUNTY	TOTAL SHEETS	SHEET NO.
KICKAPOO TRAIL	08-F3000-02-BT	CHAMPAIGN	262	216
STA.	TO STA.			
F.H.W.A. REG.	ILLINOIS	PROJECT		

FINAL SURVEY

DATE	
BY	
REVISIONS	
NO.	
DATE	
BY	
REVISIONS	
NO.	
DATE	
BY	
REVISIONS	
NO.	

ORIGINAL SURVEY

DATE	
BY	
REVISIONS	
NO.	
DATE	
BY	
REVISIONS	
NO.	
DATE	
BY	
REVISIONS	
NO.	

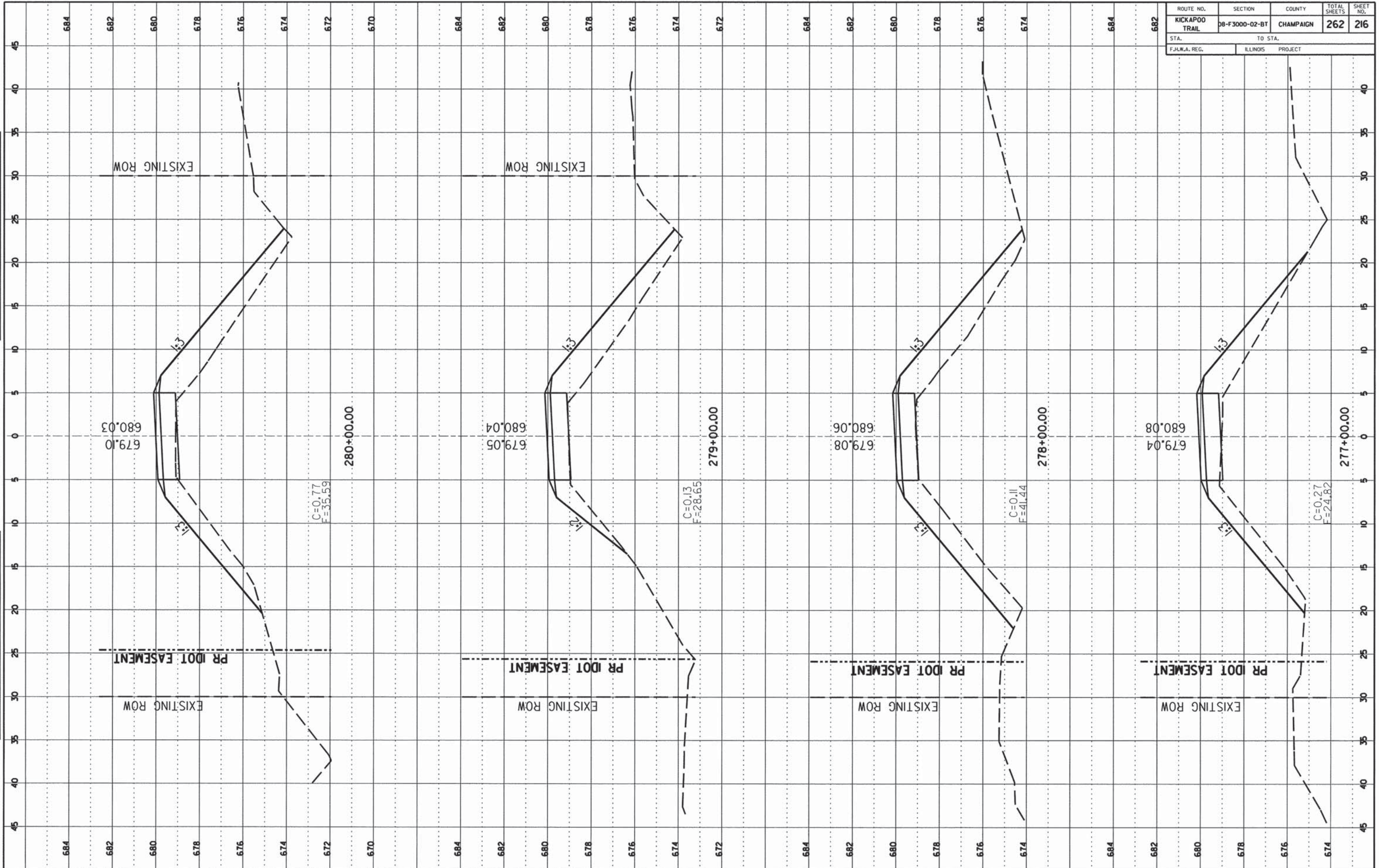



CONTRACT NO. 91520

ROUTE NO.	SECTION	COUNTY	TOTAL SHEETS	SHEET NO.
KICKAPOO TRAIL	D8-F3000-02-BT	CHAMPAIGN	262	218
STA.		TO STA.		
F.I.L.W.A. REG.		ILLINOIS PROJECT		

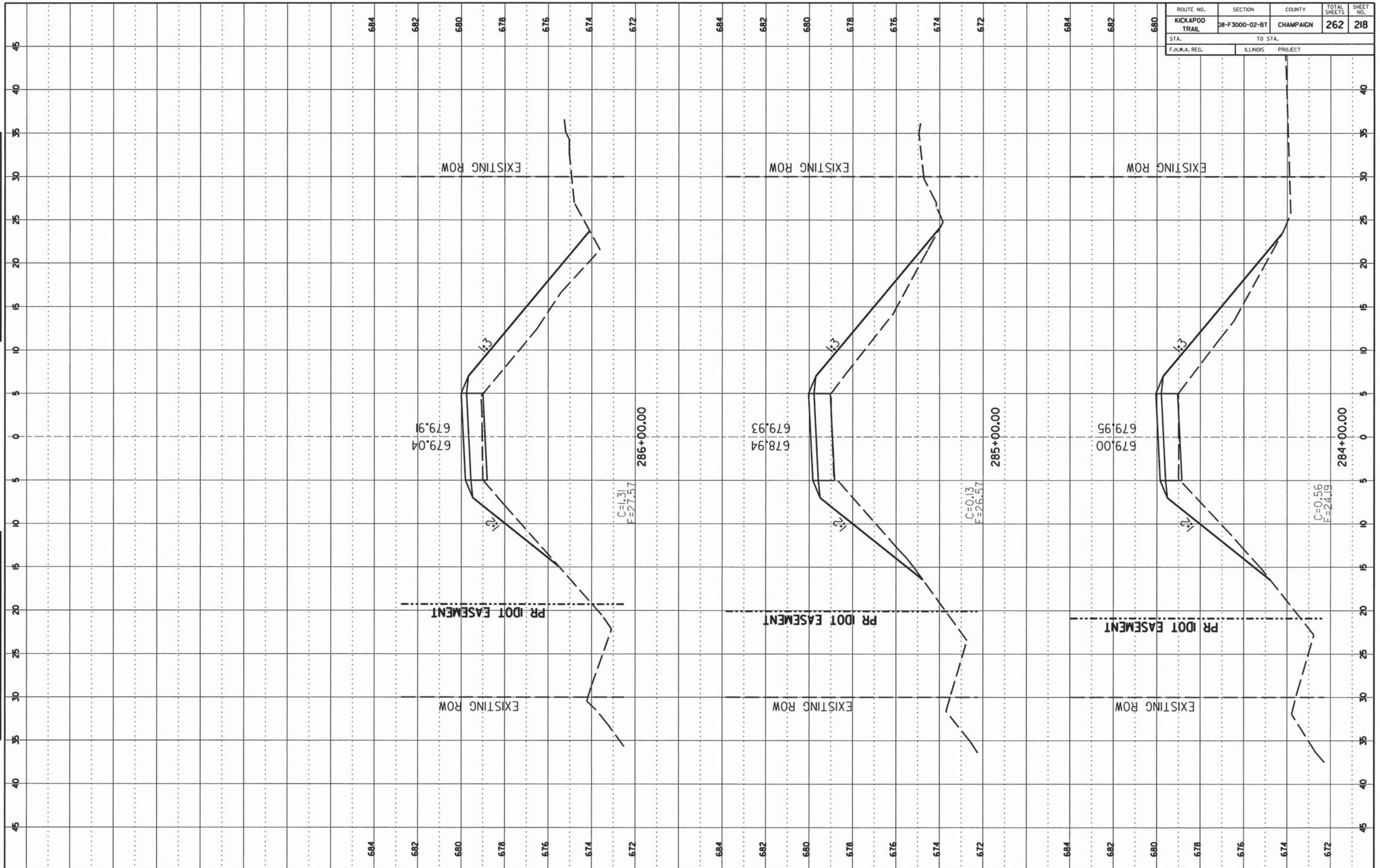

FINAL SURVEY  
 DATE: \_\_\_\_\_  
 BY: \_\_\_\_\_  
 CHECKED: \_\_\_\_\_  
 NO. \_\_\_\_\_  
 AREA CHECKED: \_\_\_\_\_

ORIGINAL SURVEY  
 DATE: \_\_\_\_\_  
 BY: \_\_\_\_\_  
 CHECKED: \_\_\_\_\_  
 NO. \_\_\_\_\_  
 AREA CHECKED: \_\_\_\_\_



CONTRACT NO. 91520

ROUTE NO. KICKAPOO TRAIL	SECTION 08-F3000-02-BT	COUNTY CHAMPAIGN	TOTAL SHEETS 262	SHEET NO. 219
STA.		TO STA.		
F.H.W.A. REG.		ILLINOIS PROJECT		

FINAL SURVEY  
 SUPERVISOR: \_\_\_\_\_  
 DATE: \_\_\_\_\_  
 CHECKED: \_\_\_\_\_  
 DATE: \_\_\_\_\_  
 NOTE BOOK NO.: \_\_\_\_\_  
 FIELD RECORD NO.: \_\_\_\_\_

ORIGINAL SURVEY  
 SUPERVISOR: \_\_\_\_\_  
 DATE: \_\_\_\_\_  
 CHECKED: \_\_\_\_\_  
 DATE: \_\_\_\_\_  
 NOTE BOOK NO.: \_\_\_\_\_  
 FIELD RECORD NO.: \_\_\_\_\_

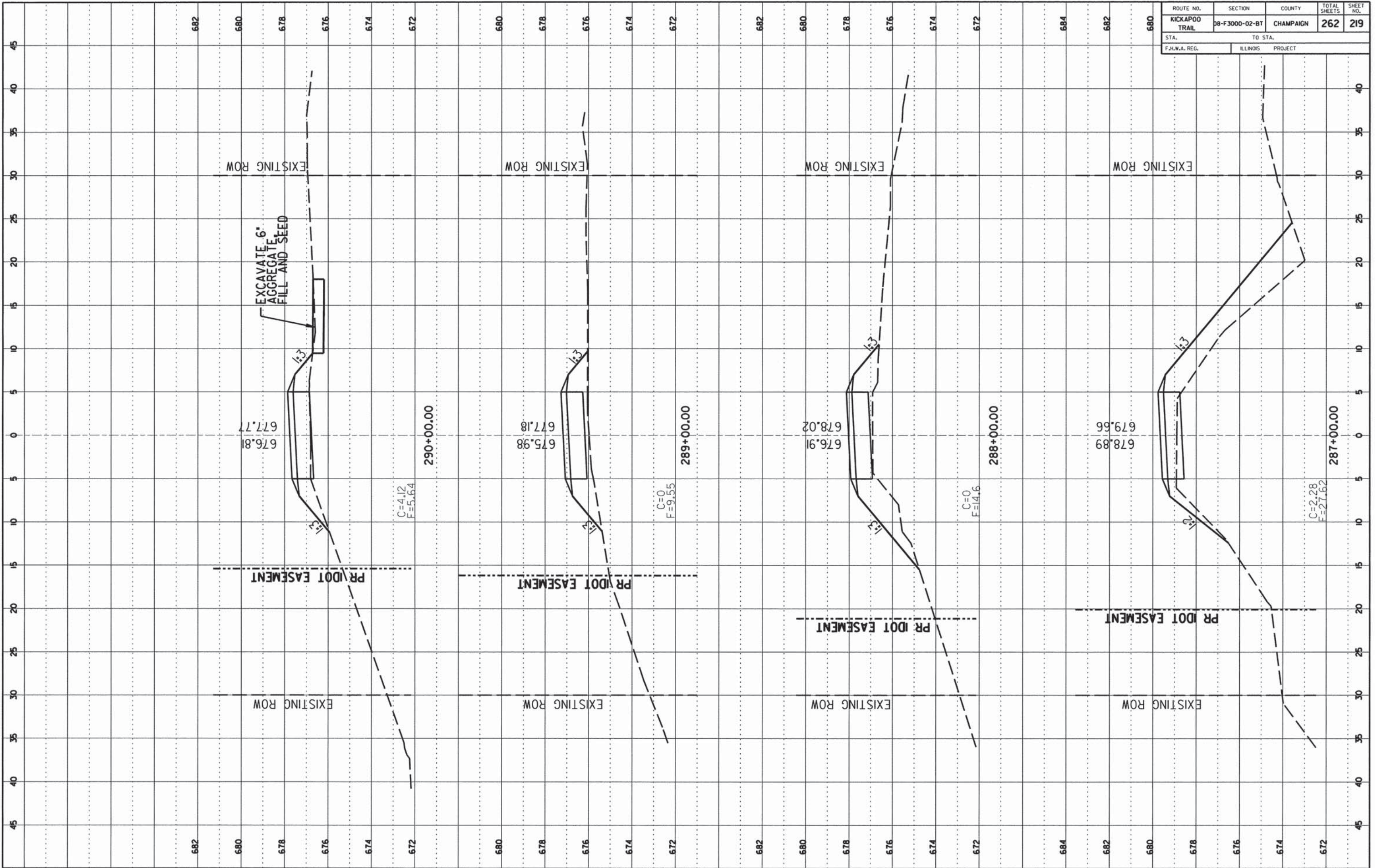

CONTRACT NO. 91520

ROUTE NO.	SECTION	COUNTY	TOTAL SHEETS	SHEET NO.
KICKAPOO TRAIL	08-F3000-02-BT	CHAMPAIGN	262	221
STA. TO STA.		ILLINOIS PROJECT		
F.H.W.A. REG.				

FINAL SURVEY  
 NO. \_\_\_\_\_  
 DATE \_\_\_\_\_

ORIGINAL SURVEY  
 NO. \_\_\_\_\_  
 DATE \_\_\_\_\_

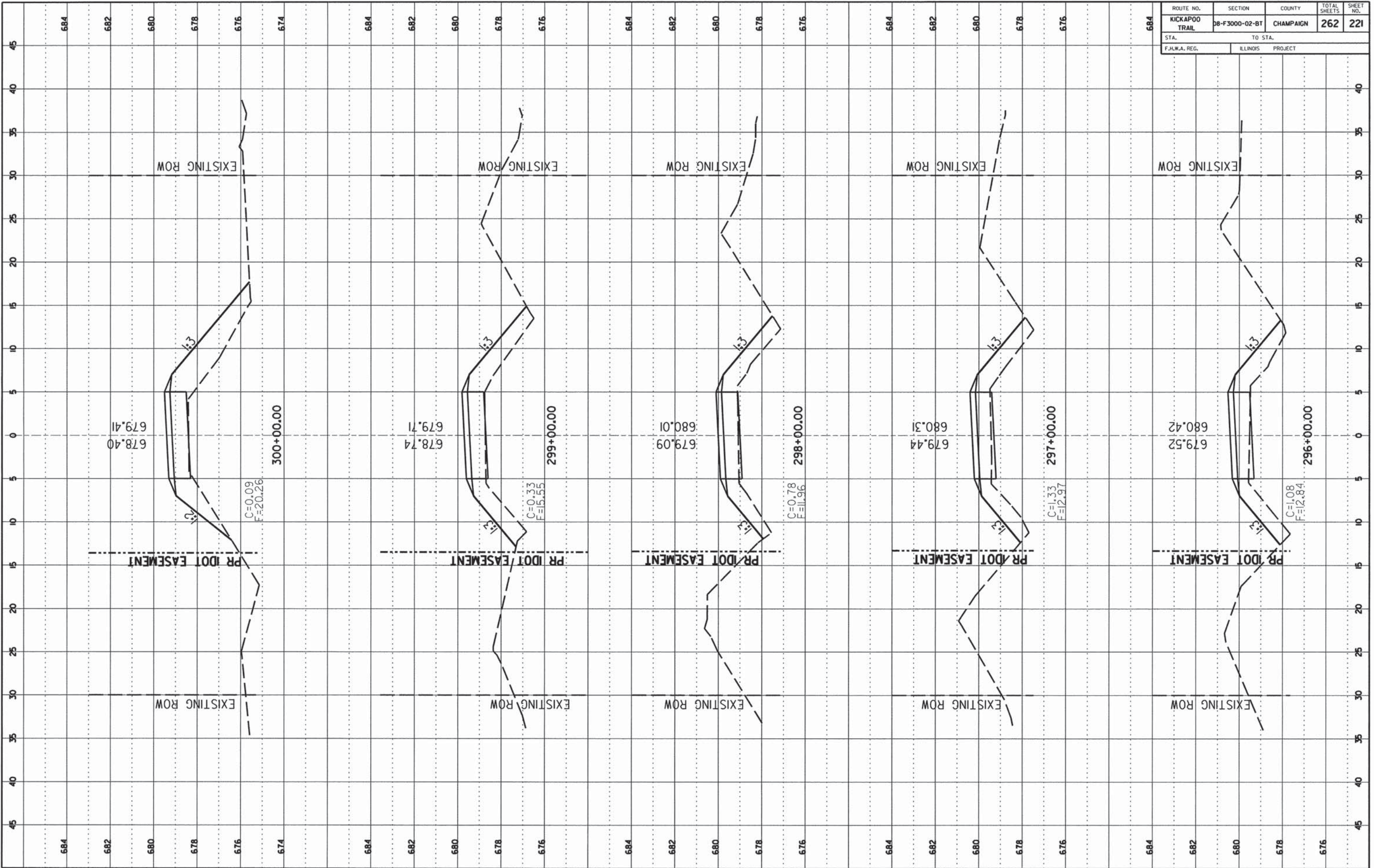



CONTRACT NO. 91520

ROUTE NO.	SECTION	COUNTY	TOTAL SHEETS	SHEET NO.
KICKAPOO TRAIL	08-F3000-02-BT	CHAMPAIGN	262	223
STA.	TO STA.			
F.H.W.A. REG.	ILLINOIS PROJECT			

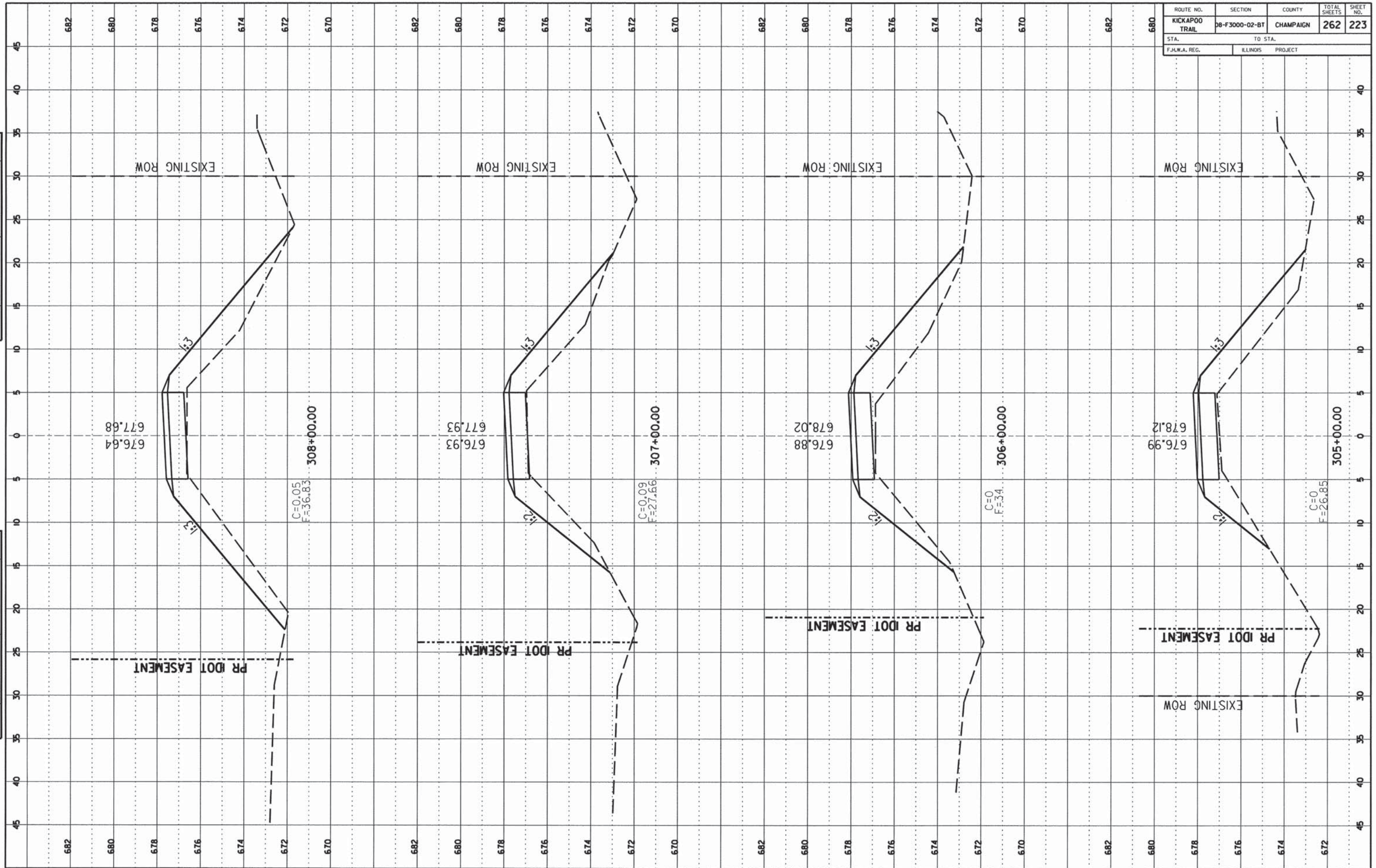

FINAL SURVEY  
 NO. \_\_\_\_\_ DATE \_\_\_\_\_  
 SURVEYED BY \_\_\_\_\_  
 CHECKED BY \_\_\_\_\_  
 DRAWN BY \_\_\_\_\_  
 DATE \_\_\_\_\_

ORIGINAL SURVEY  
 NO. \_\_\_\_\_ DATE \_\_\_\_\_  
 SURVEYED BY \_\_\_\_\_  
 CHECKED BY \_\_\_\_\_  
 DRAWN BY \_\_\_\_\_  
 DATE \_\_\_\_\_



CONTRACT NO. 91520

ROUTE NO.	SECTION	COUNTY	TOTAL SHEETS	SHEET NO.
KICKAPOO TRAIL	08-F3000-02-BT	CHAMPAIGN	262	228
STA.	TO STA.			
F.H.W.A. REG.	ILLINOIS PROJECT			

NO.	DATE	BY	REVISION

NO.	DATE	BY	REVISION

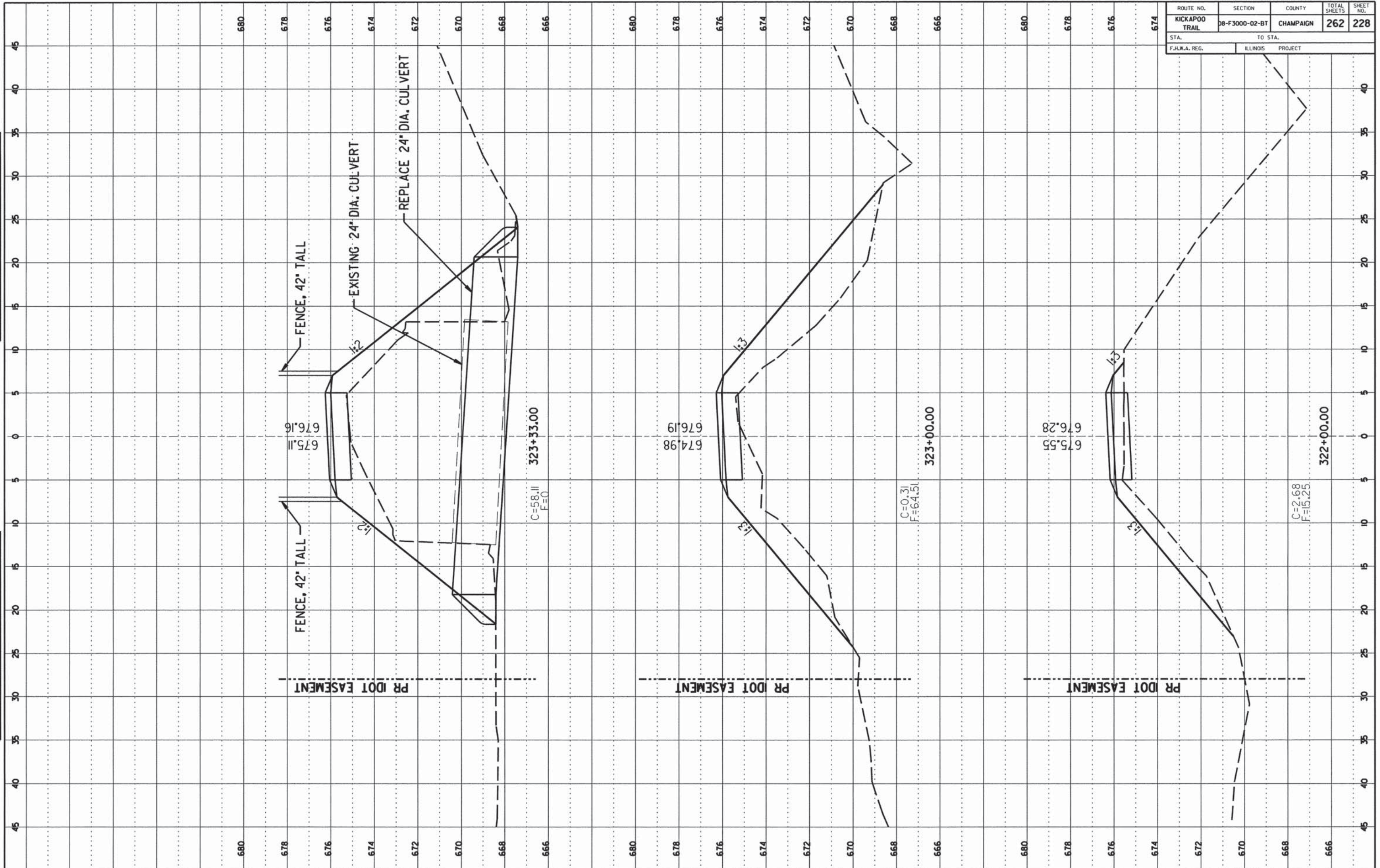

CCFPD KICKAPOO BIKE TRAIL

CHAMPAIGN COUNTY

SHEET 228 OF 262 SHEETS 13-620A

CONTRACT NO. 91520

ROUTE NO.	SECTION	COUNTY	TOTAL SHEETS	SHEET NO.
KICKAPOO TRAIL	DB-F3000-02-BT	CHAMPAIGN	262	231
STA. TO STA.		ILLINOIS PROJECT		
F.H.W.A. REG.				

FINAL SURVEY

DATE	
BY	
SPRINTED	
PLOTTED	
TRIMMED	
NO. 1	
NO. 2	
NO. 3	
NO. 4	
NO. 5	

ORIGINAL SURVEY

DATE	
BY	
SPRINTED	
PLOTTED	
TRIMMED	
NO. 1	
NO. 2	
NO. 3	
NO. 4	
NO. 5	

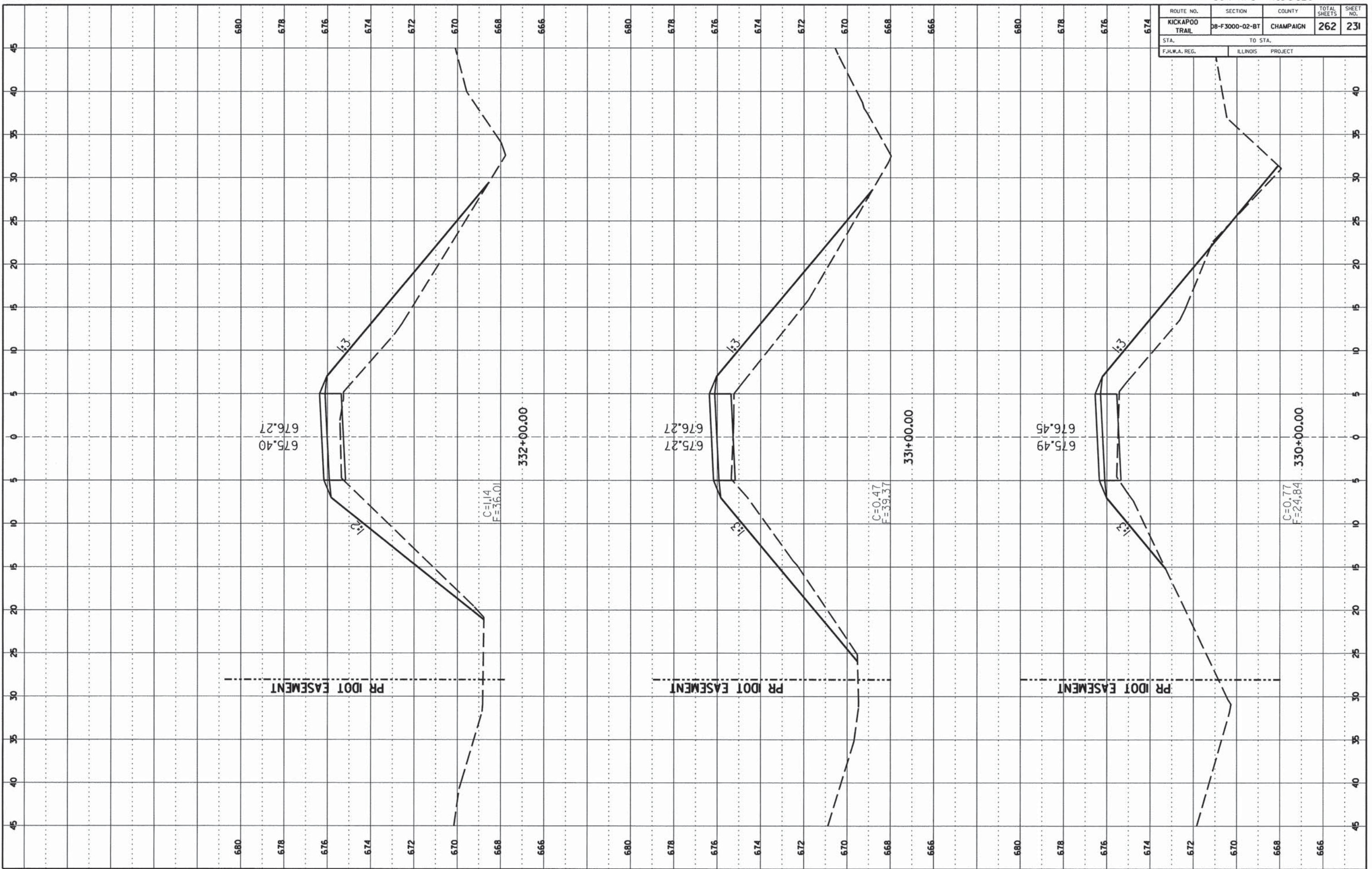

CCFPD KICKAPOO BIKE TRAIL

CHAMPAIGN COUNTY





CONTRACT NO. 91520

ROUTE NO.	SECTION	COUNTY	TOTAL SHEETS	SHEET NO.
KICKAPOO TRAIL	08-F3000-02-BT	CHAMPAIGN	262	239
STA.	TO STA.			
F.H.W.A. REG.	ILLINOIS	PROJECT		

FINAL SURVEY

DATE	
BY	
REVISION	
NO.	

ORIGINAL SURVEY

DATE	
BY	
REVISION	
NO.	

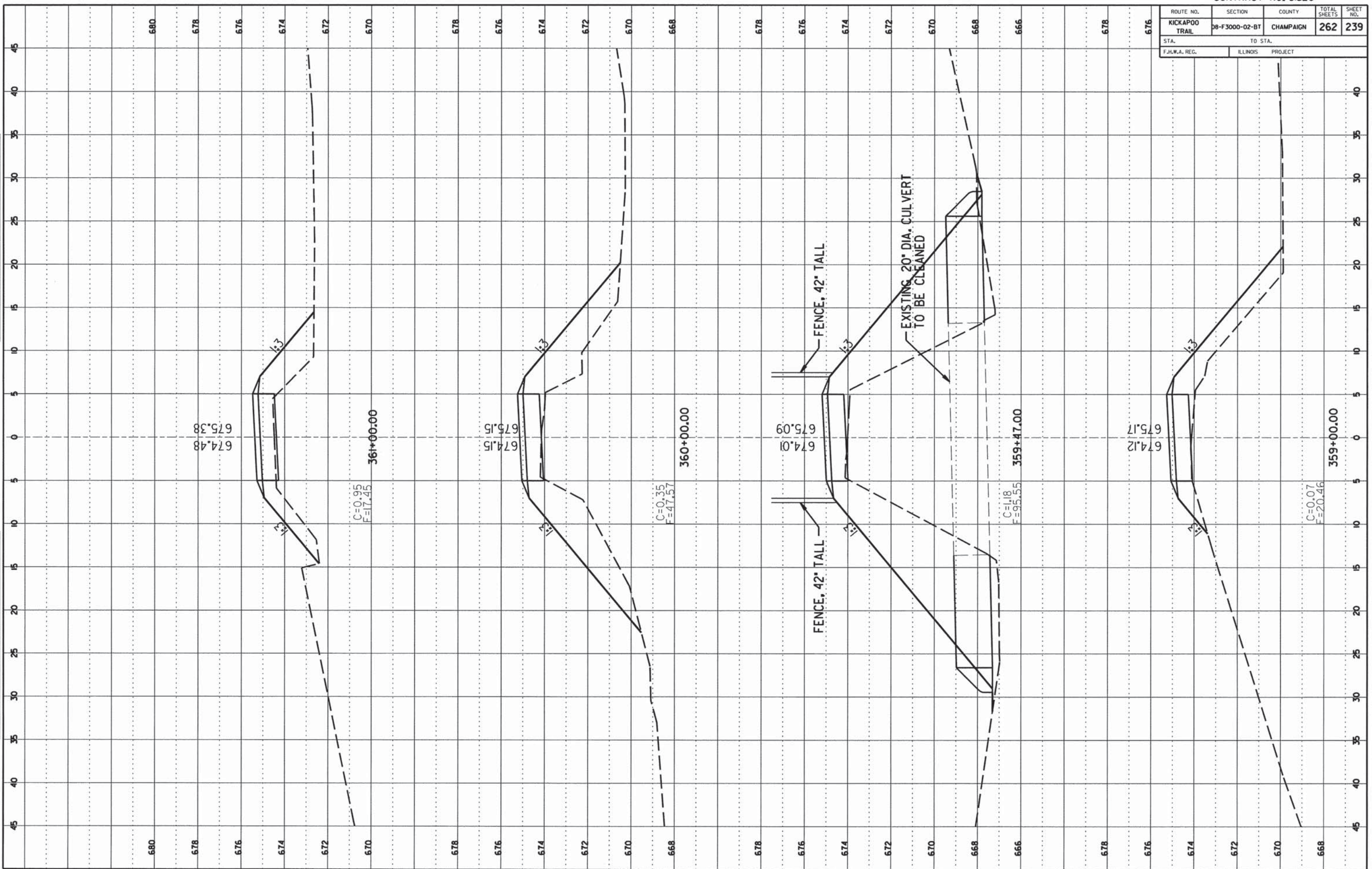

CCFPD KICKAPOO BIKE TRAIL

CHAMPAIGN COUNTY

SHEET 239 OF 262 SHEETS 13-620A

CONTRACT NO. 91520

ROUTE NO.	SECTION	COUNTY	TOTAL SHEETS	SHEET NO.
KICKAPOO TRAIL	DB-F3000-02-BT	CHAMPAIGN	262	242
STA. TO STA.		ILLINOIS PROJECT		
F.H.W.A. REG.				

FINAL SURVEY  
 DIRECTOR: \_\_\_\_\_  
 PLOTTED: \_\_\_\_\_  
 NOTE BOOK NO.: \_\_\_\_\_  
 DATE: \_\_\_\_\_

ORIGINAL SURVEY  
 DIRECTOR: \_\_\_\_\_  
 PLOTTED: \_\_\_\_\_  
 NOTE BOOK NO.: \_\_\_\_\_  
 DATE: \_\_\_\_\_

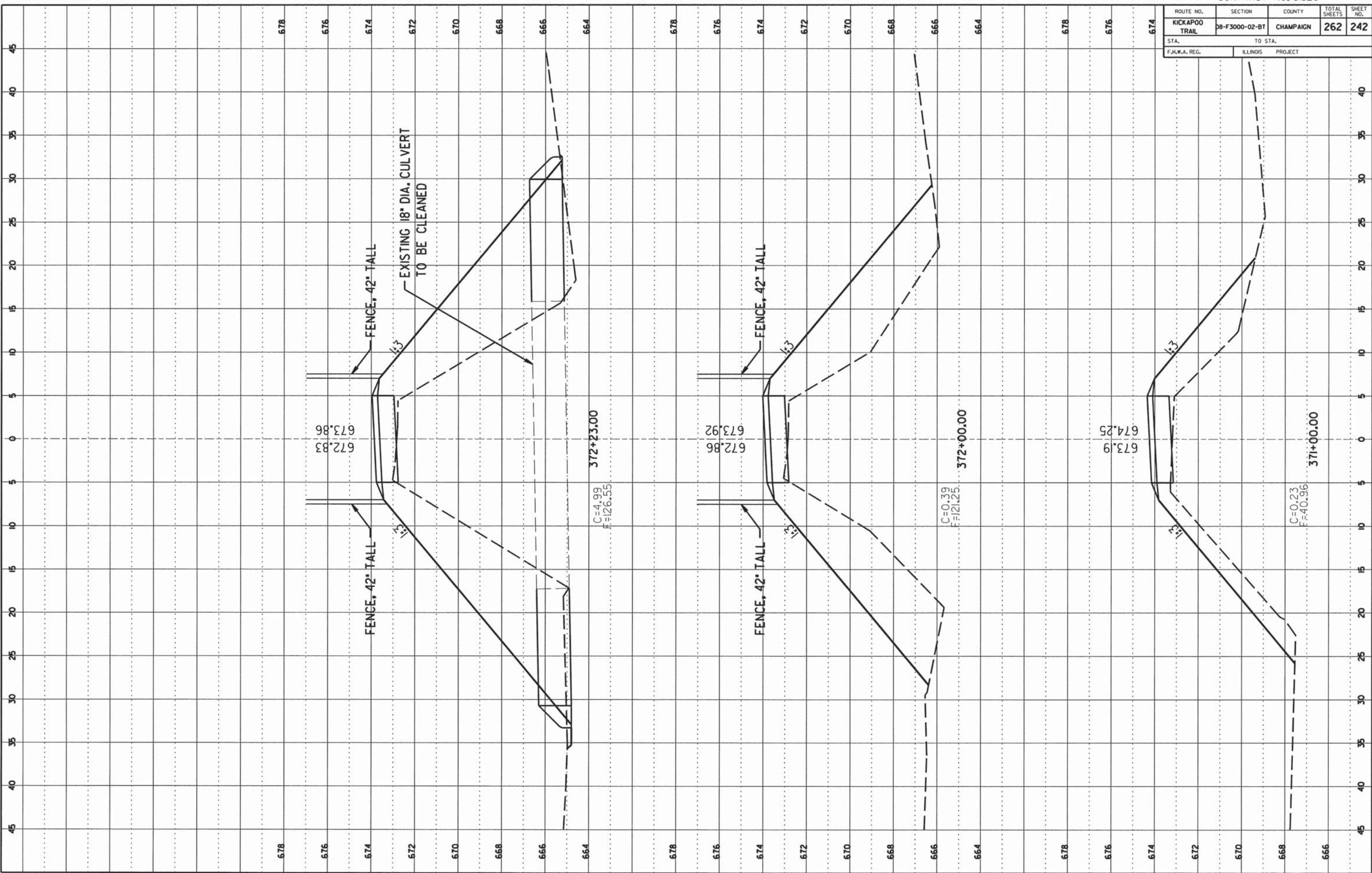

CCFPD KICKAPOO BIKE TRAIL

CHAMPAIGN COUNTY

SHEET 242 OF 262 SHEETS 13-620A

CONTRACT NO. 91520

ROUTE NO.	SECTION	COUNTY	TOTAL SHEETS	SHEET NO.
KICKAPOO TRAIL	DB-F3000-02-BT	CHAMPAIGN	262	244
STA.		TO STA.		
F.H.W.A. REG.		ILLINOIS PROJECT		

DATE	BY

FINAL SURVEY  
NOTE BOOK NO. \_\_\_\_\_

DATE	BY

ORIGINAL SURVEY  
NOTE BOOK NO. \_\_\_\_\_

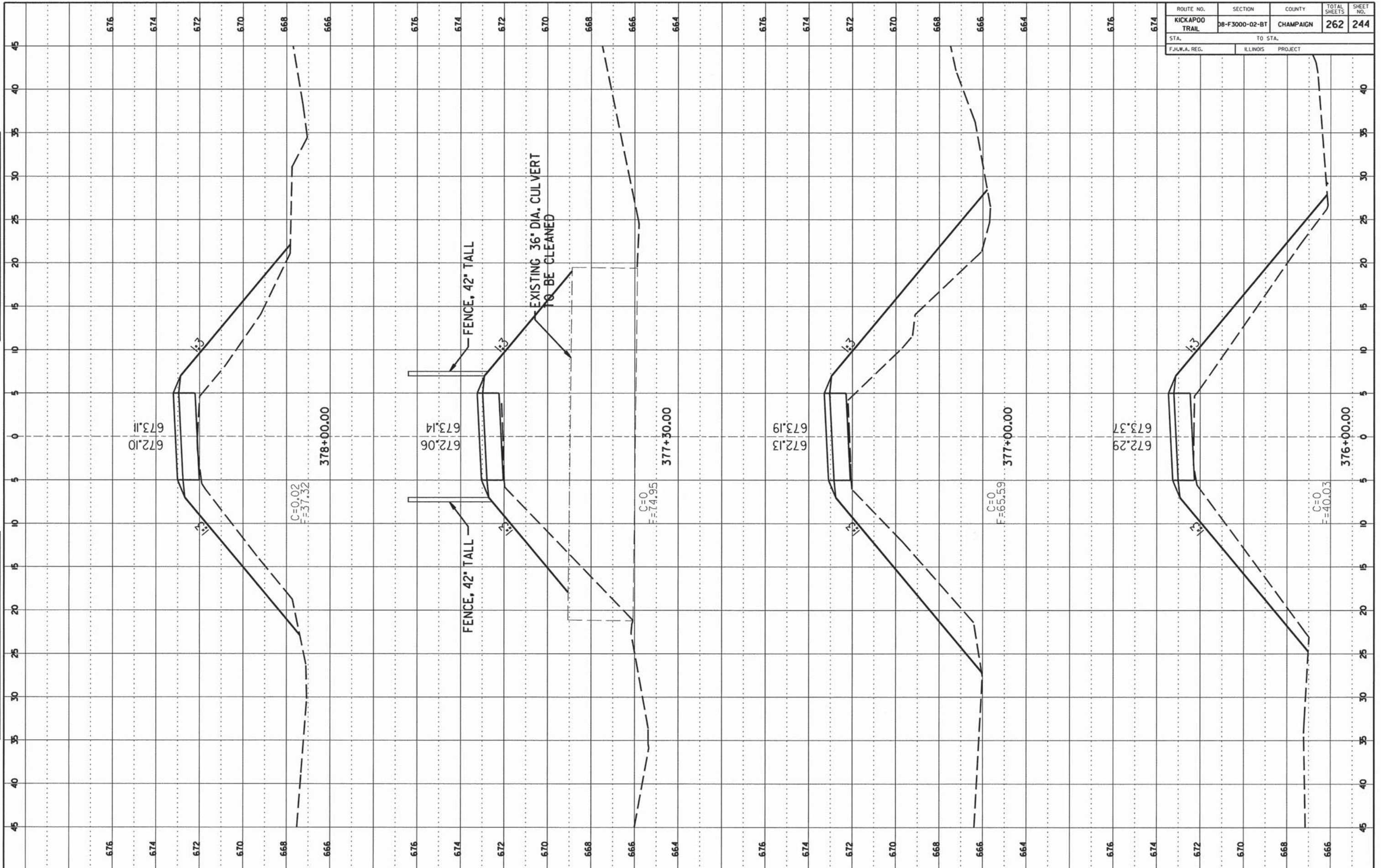

CCFPD KICKAPOO BIKE TRAIL

CHAMPAIGN COUNTY

SHEET 244 OF 262 SHEETS 13-620A

CONTRACT NO. 91520

ROUTE NO.	SECTION	COUNTY	TOTAL SHEETS	SHEET NO.
KICKAPOO TRAIL	DB-F3000-02-BT	CHAMPAIGN	262	249
STA.		TO STA.		
F.H.W.A. REG.		ILLINOIS PROJECT		

FINAL SURVEY	DATE
NO. _____	_____
NOTE BOOK NO. _____	
AREAS DELETED _____	

ORIGINAL SURVEY	DATE
NO. _____	_____
NOTE BOOK NO. _____	
AREAS DELETED _____	

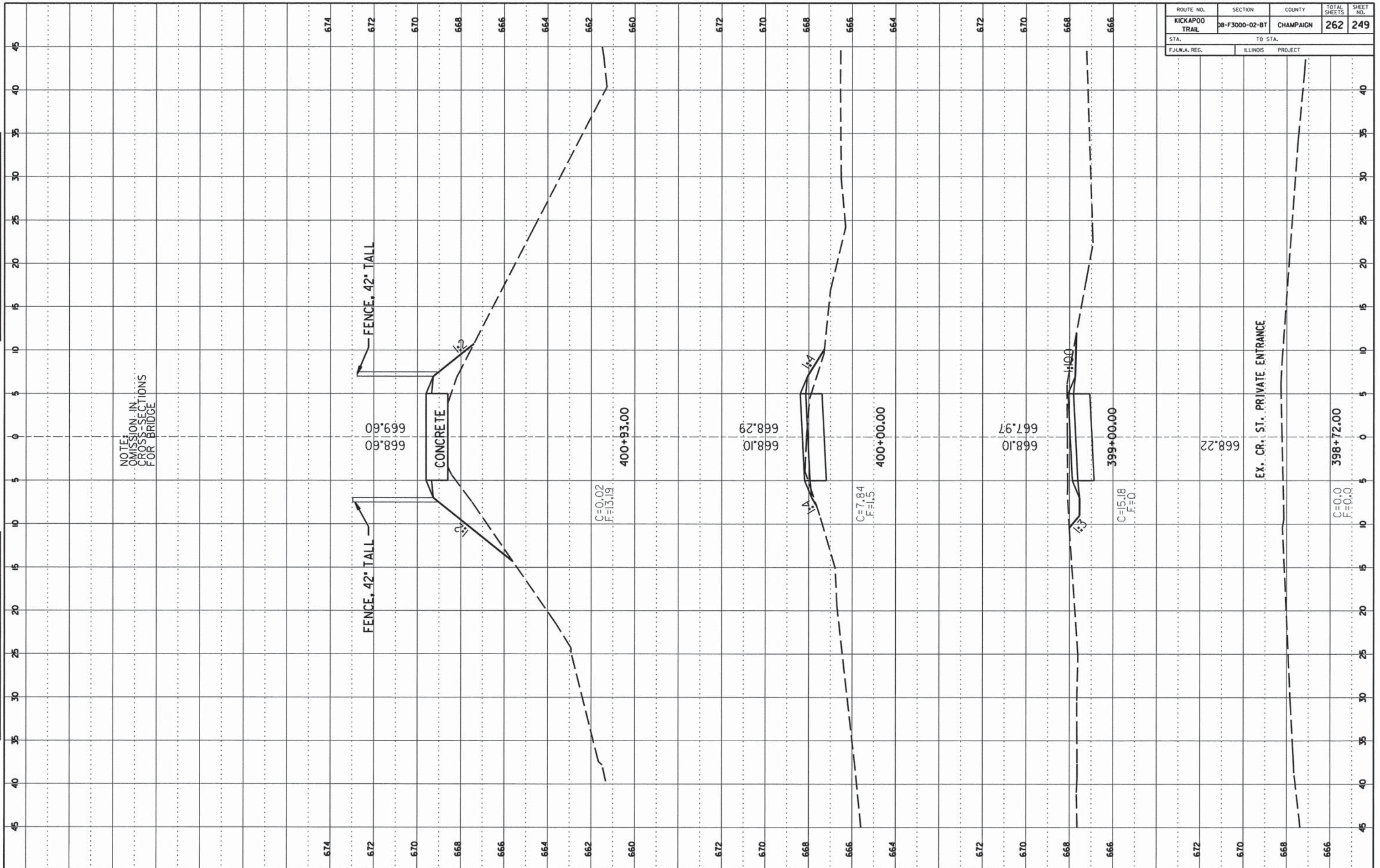

CONTRACT NO. 91520

ROUTE NO.	SECTION	COUNTY	TOTAL SHEETS	SHEET NO.
KICKAPOO TRAIL	08-F3000-02-BT	CHAMPAIGN	262	250
STA.		TO STA.		
F.H.W.A. REG.		ILLINOIS PROJECT		

FINAL SURVEY  
 NO. \_\_\_\_\_  
 DATE \_\_\_\_\_

ORIGINAL SURVEY  
 NO. \_\_\_\_\_  
 DATE \_\_\_\_\_

